



AR4-MK5

User Build Manual

Version 1.1



Annin Robotics

www.anninrobotics.com

Contents:

- [Electrical Safety](#)
- [Overview](#)
- [Chapter 1 – Robot Bill of Materials](#)
- [Chapter 2 – Robot Assembly](#)
- [Chapter 3 – PLC Modbus Option](#)
- [Chapter 4 – Pneumatic Gripper](#)
- [Chapter 5 – Servo Gripper](#)
- [Chapter 6 – Addition Axis](#)
- [Chapter 7 – Spec's / Diagrams](#)
- [Chapter 8 – Startup Procedure](#)
- [Chapter 9 – Programming](#)
- [Version Log](#)



Electrical Safety

- ▶ **ELECTRIC SHOCK HAZARD.** The construction of this control enclosure poses potential exposure to alternating current and direct current which has the potential to cause injury or death. This equipment should be constructed and serviced by trained or qualified persons.
- ▶ Keep the area around the device clear and free from dust before, during, and after installation.
- ▶ Wear safety glasses if you are working under any conditions that could be hazardous to your eyes.
- ▶ Do not perform any actions that create a potential hazard to people or make the equipment unsafe.
- ▶ Never install or manipulate wiring during electrical storms.
- ▶ Never install electrical jacks in wet locations unless the jacks are specifically designed for wet environments.
- ▶ Operate the device only when it is properly grounded.
- ▶ Ensure that the separate protective earthing terminal provided on this device is permanently connected to earth.
- ▶ Replace fuses only with fuses of the same type and rating.
- ▶ Do not open or remove chassis covers or sheet-metal parts unless instructions are provided in the hardware documentation for this device. Such an action could cause severe electrical shock.
- ▶ Do not push or force any objects through any opening in the chassis frame. Such an action could result in electrical shock or fire.
- ▶ Avoid spilling liquid onto the chassis or onto any device component. Such an action could cause electrical shock or damage the device.
- ▶ Avoid touching uninsulated electrical wires or terminals that have not been disconnected from their power source. Such an action could cause electrical shock.
- ▶ Always ensure that all modules, power supplies, and cover panels are fully inserted and that the installation screws are fully tightened.



OVERVIEW

About building this robot:

The AR4 is an open design 6 axis robot that anyone can build. All software, print files and manuals are available for download on the Annin Robotics website downloads page. All the components you need to build this robot are outlined in Chapter 1. The assembly of the robot arm is outlined in Chapter 2. Chapter 3 covers the installation of a pneumatic gripper on the robot and Chapter 4 covers the installation of a servo gripper on the robot. (both chapters on robot grippers have a separate bill of materials listing the items needed for each type of gripper).

Components Needed to Build this Robot:

The following is an overview of the 5 component groups needed:

- **3D covers and spacers** (you must print these yourself) see chapter one “spacers and covers” section.
- **Structural components** - You can print these yourself to build a 3D printed robot or you can purchase an aluminum parts kit from the robot kits page to build your robot from aluminum <https://www.anninrobotics.com/robot-kits>. There are 27 structural components – see chapter one “structural components” section.
- **Hardware components** – this includes the bearings, belts, pulleys, sprockets, chain, shafts, pins, machine screws and set screws. These can be purchased from multiple sources – see chapter one “hardware components” section. If you have difficulty finding these component or wish to buy them all in one place I buy them all in bulk and have made a hardware components kit available on the robot kits page: <https://www.anninrobotics.com/robot-kits>.
- **Stepper Motors and Drivers** – the 6 motors, drivers and power supply are available directly from Stepperonline, there is a link to this package on the robot kits page: <https://www.anninrobotics.com/robot-kits>.
- **Electrical components** – The primary electrical components can be purchased on the robot kits page or can be sources separately – all parts are listed in the bill of materials.



General Robot Assembly notes:

- Use only low strength thread locking compound on 4mm and larger screws – do not use on 3mm and smaller screws.
- All belts should be tensioned using moderate tension (do not over tighten or stress belts or components).

Tools & Materials Needed:

- General hand tools including metric hex key set, locking pliers, wire cutters, wire strippers.
- Soldering Iron and flux core silver bearing solder.
- 1.5mm or 2mm heat shrink tubing for most connections. A short length of 6mm heat shrink tube is used for the servo gripper in chapter 4.
- Heat gun or lighter for shrink tubing.
- Digital calipers.
- Magnet polarity tester.
- 3D printer and printer filament.
- Various size drill bits for clearing holes in 3D printed components.
- M3 and M4 taps for threading plastic components.
- A digital level is recommended to assist in fine tuning the robots auto calibration.
- A general angle gauge is used to set the position of Joint #5.
- White lithium grease or general-purpose grease.
- Bearing retaining compound.
- Low strength thread locking compound.
- Liquid electrical tape.
- Electrical harness tape (black cloth)
- Cable ties, medium and small.

Bearing Fit:

The CAD models for the AR4 robot are sized for a slight press fit on all bearing and race diameters. The assembly steps in this manual also reference pressing the bearings and races in place. I have tried to make sure the aluminum kits offered are closer to a slip or light press fit. If bearings get improperly wedged or tilted and then attempt to press, severe damage can occur – use a quality bearing press, arbor press or vise and be very careful that bearing races are pressed or inserted square and true to the housing body. **NEVER USE A HAMMER.** Aluminum housings can be heated with a heat gun or mug warmer to increase size and assist in inserting bearings. If the tolerance stack up on your components results in a race that is slightly loose, please use bearing retaining compound to alleviate any movement. If the tolerance stack up of your components result in a shaft that is slight too tight shafts can be carefully polished until a slip fit is achieved - bearings can also be warmed up with a heat gun or placed on a mug warmer to slightly increase size and make insertion onto aluminum shafts a little easier.

▶ A small amount of white lithium or standard bearing grease is recommended on all bearings.

3D Printed covers and spacer:

You can print your covers and spacers in any color you choose. I recommend printing the parts using PETG as it's a stronger material and fairly easy to drill and tap where called for. You can use PLA but it is very brittle and very difficult to drill and tap for the few parts that call for tapped holes.

3D Printing The Entire Robot:

This manual shows the construction of the robot using aluminum for the main structural components but the robot can also be constructed using all 3D printed components. The .stl print files for all components are here: <https://www.anninrobotics.com/downloads> The construction illustrated in this manual is the same using either aluminum or 3D printed components - note the following details if using 3D printed components:

- 3D printed components require all threaded holes to be cleared with appropriate drill size and then tapped.
- All printed structural components were printed at minimum 50% infill with the exception of the J2 and J3 drive spindles and tension rings which were printed at 90%+ solid. Parts were printed at 2mm layer height and 5 layer thick shells.
- All printed covers and spacers were printed at 20% infill at .2mm layer height and 5 layer thick shells.
- The robots I have 3D printed were made using ABS at 220° nozzle temperature. I have not personally tried using other materials but I have received feedback from numerous people who have used PLA, PETG and carbon fiber reinforced filaments without issues.
- The J1 baseplate, J1 baseplate spacer and J2 arm larger than most 3D printer beds and therefore are printed in 2 pieces and require being epoxied together.
- The J1 spindle is printed in 2 pieces and requires the center alignment plug be epoxied into the end of the spindle – this is the center hub that centers the 60T timing pulley.
- The printed design calls for additional reinforcements to be epoxide in place around the J1 base and at the base of the J2 arm (see details at the end of this manual)
- The J4 tube cannot be 3D printed; if building a fully 3D printed robot you will need to cut and drill aluminum tubing as shown in structural components BOM section of chapter 1.
- 2 spools of filament are needed for printing the primary structural components. A 3rd spool is needed if you wish to print your covers and spacers in a different color.

GRIPPERS AND 5V DEVICES:

The software has the ability to control grippers or any other clamp or servo device you need the robot to control. When you review the chapters on pneumatic and servo grippers you will find an additional Arduino board is needed. The reason for this is that the Teensy board operates at 3.3v and has limited pins available therefore I wrote the software to use this Arduino Nano or Mega board for controlling peripheral devices – also this board operates at 5v and 5v relays and servos are much more common and reliable than 3.3 which is why the teensy is only used for control of the robot arm.

Using Braided Sleeve

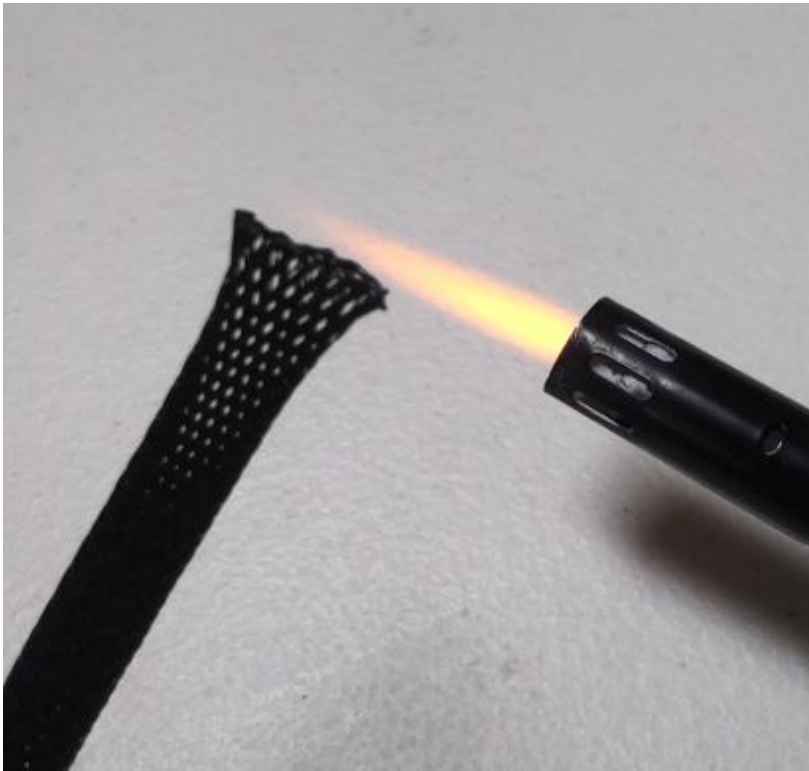

Several Steps in this manual will call for braided sleeve to be placed over electrical wires. Make sure that as soon as you cut any braided sleeve you use a lighter or flame to carefully melt the ends of the sleeve as shown.

If you do not melt the ends the sleeve will un-braid and not hold the wires together.

Soldering Wire Connections

I've had several people ask why we solder most of the motor harness connections. Earlier versions of the design did incorporate plug connectors and pre-built wiring harnesses. However, across a range of applications, motions, and articulations, the low-cost connectors we evaluated consistently proved to be unreliable over time.

Given the compact nature of the arm, along with its limited cable routing and tight bend radii, direct soldered connections—placed in strategic locations and protected with heat shrink—have proven to be the better solution. This approach is more reliable, less bulky, more cost-effective, and often less time-consuming than crimping and assembling multiple connector pins.

Please review the next few pages for helpful tips on proper soldering techniques.



Soldering Wire Connections

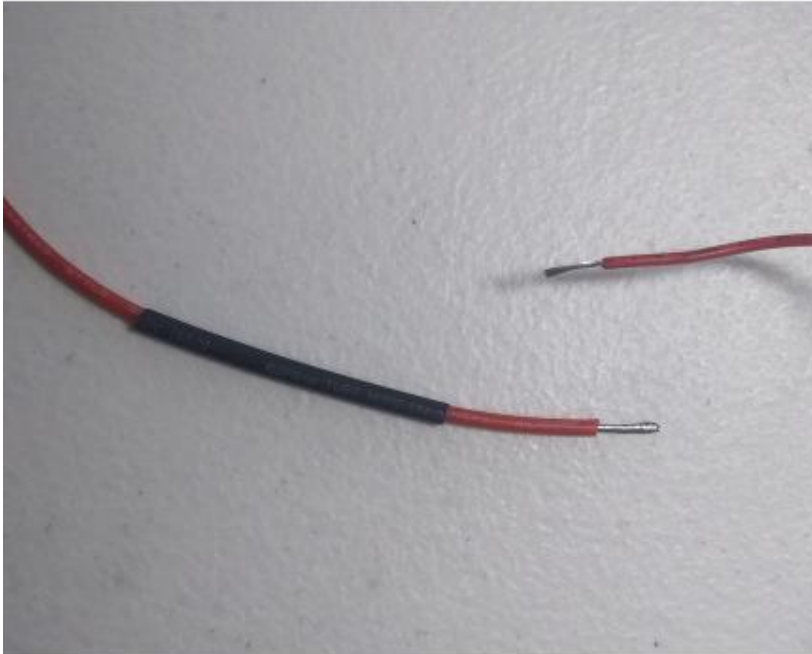

Several steps in this manual will call for soldering and heat shrinking wire connections together.

Strip wire ends of both wires and twist wire strands.

Insert length of heat shrink tube over one of the wire ends.

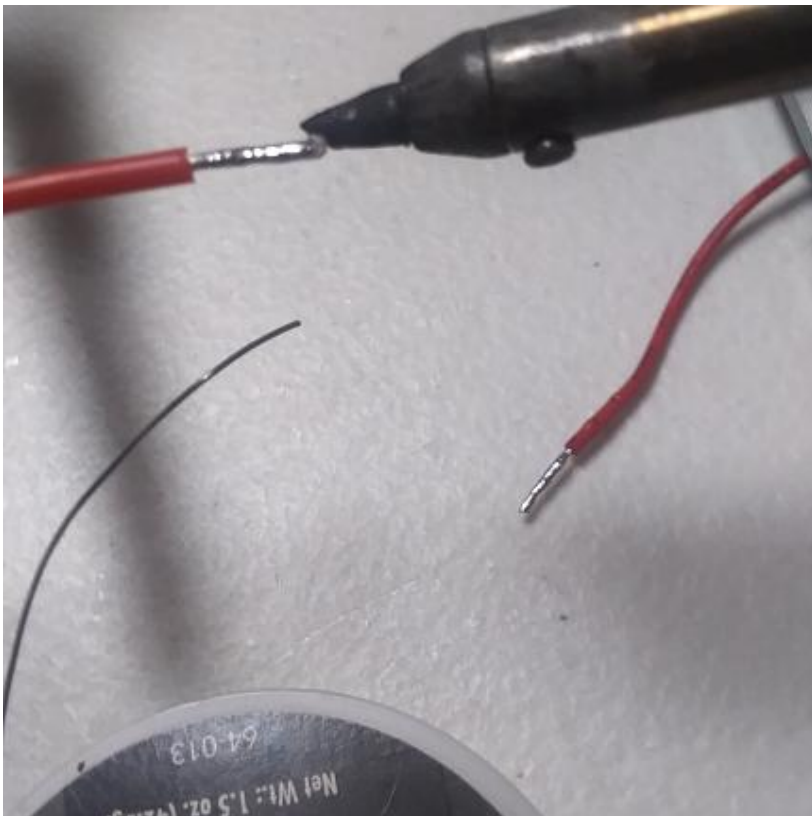

Use soldering iron and rosin core electrical solder to pre apply solder to the ends of each wire.

This is also known as "tinning" the wire end.



Use soldering iron to melt solder on both wire ends so that wire ends are overlapping and solder forms a complete bond between the two wire ends.

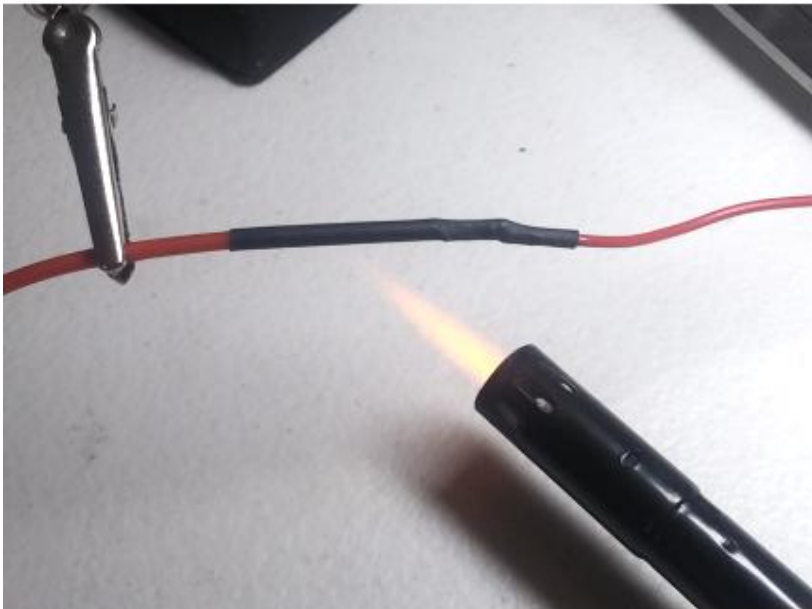

Slide the heat shrink tube over the solder joint and then use a lighter flame to shrink the tubing over the joint.

Gently sweep the flame back and forth over the heat shrink tubing taking care not to apply too much heat.

Do not use open flame around any combustible materials and be careful not to inadvertently melt any of your plastic components or braided sleeve.



Removing jacket and shielding from continuous flex Cat6 cable

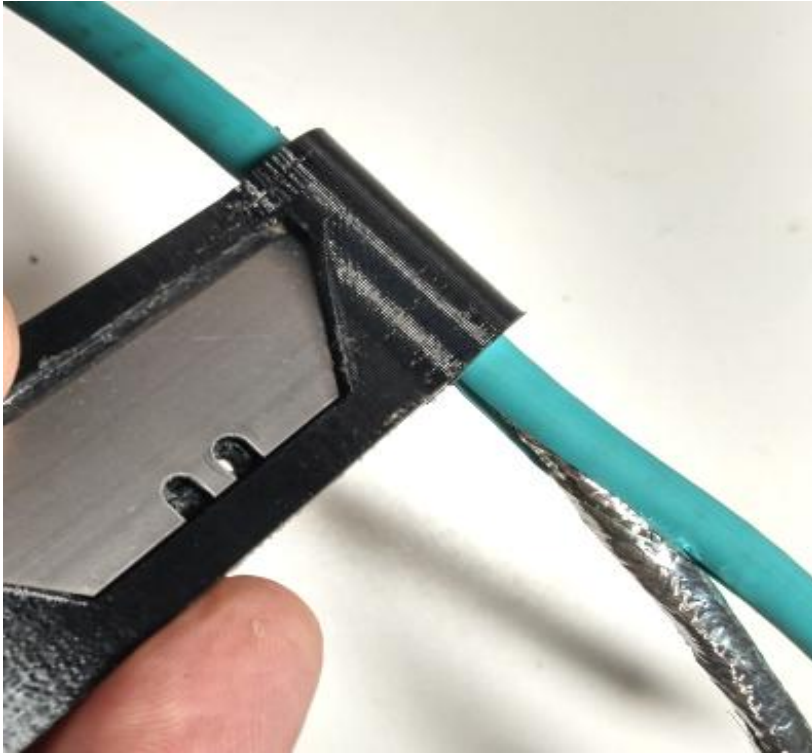

Install razor blade into 3D printed CF Cat6 Jacket Stripper and then feed cable through the round passage in tool.

The jacket will be split as it passes through and you can then peel off the jacket.



Remove foil wrap from around cable shielding.

Several steps in the manual will call for removing a length of shielding from the end of Cat6 cable.

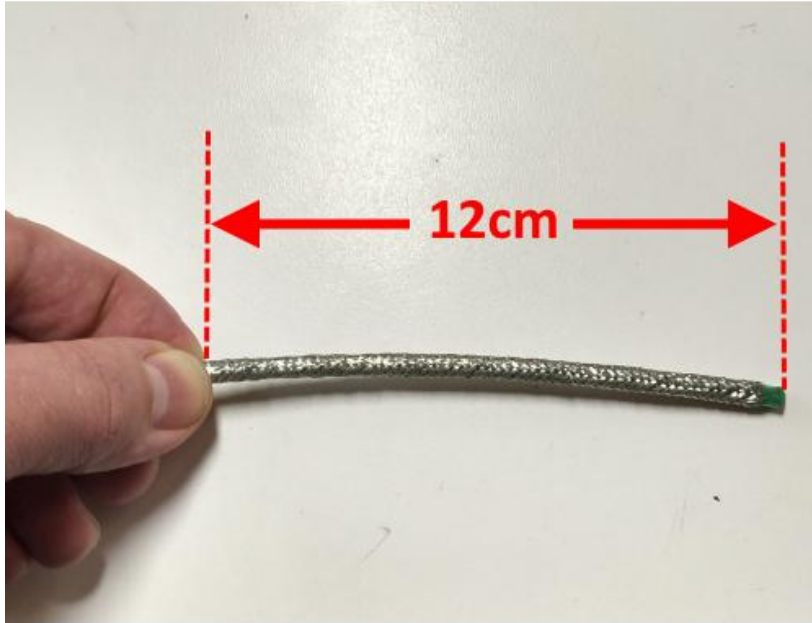

In this example I will remove 12cm of shielding.

In one hand pinch the cable at the position you want to remove the shielding from.

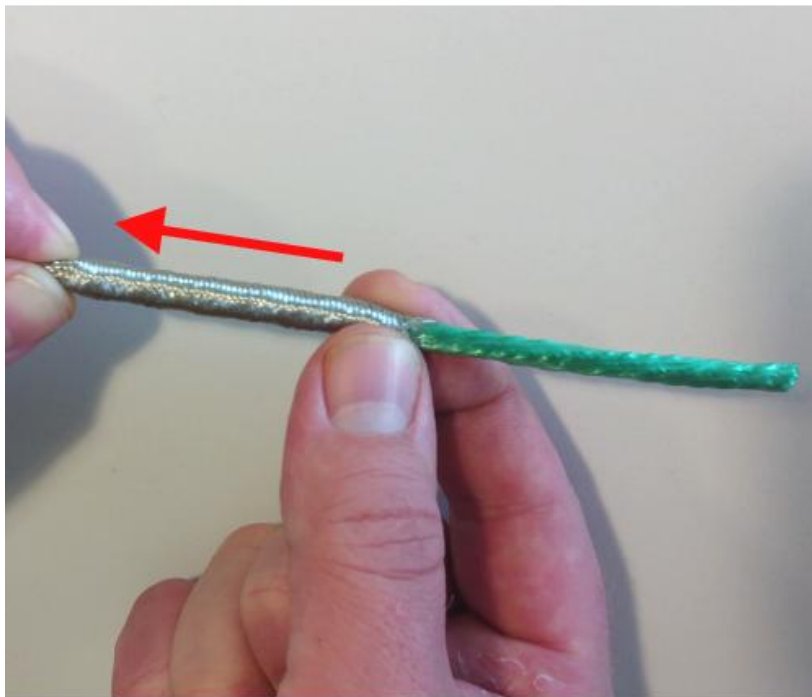

Keep the cable pinched at the 12cm point and then push or bunch up the shielding to be removed toward the pinch point.





At the 12cm pinch point use a pair of sharp point cutters to get under the bunched up shielding.

CAUTION: be extremely careful to only get cutter blade under the shielding, it is very easy to accidentally snag and cut one of the wires.



Carefully cut a portion of the shielding as shown. Be very careful to only cut shielding.

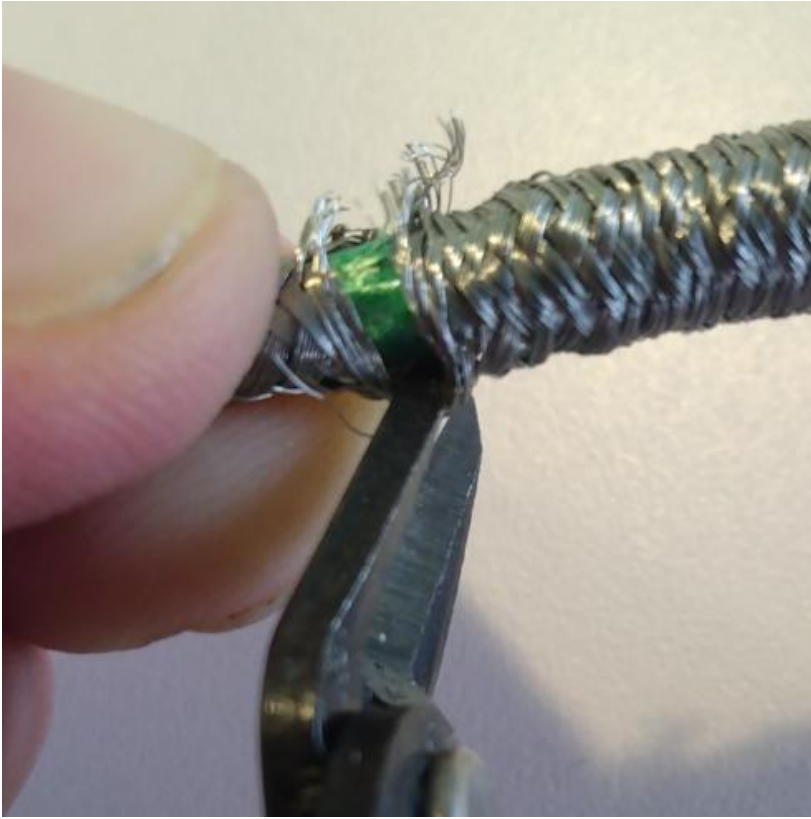

Carefully cut remaining shielding around perimeter of cable.

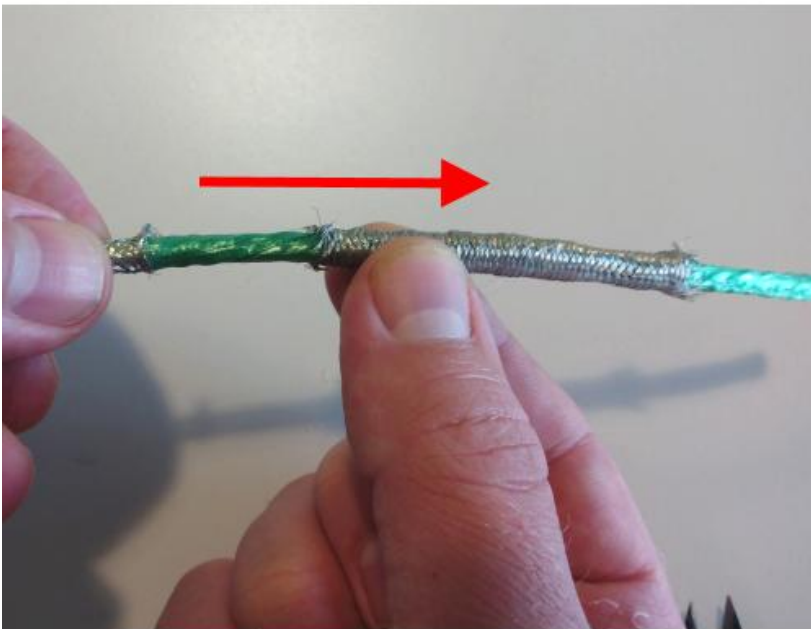

Remove shielding as shown.



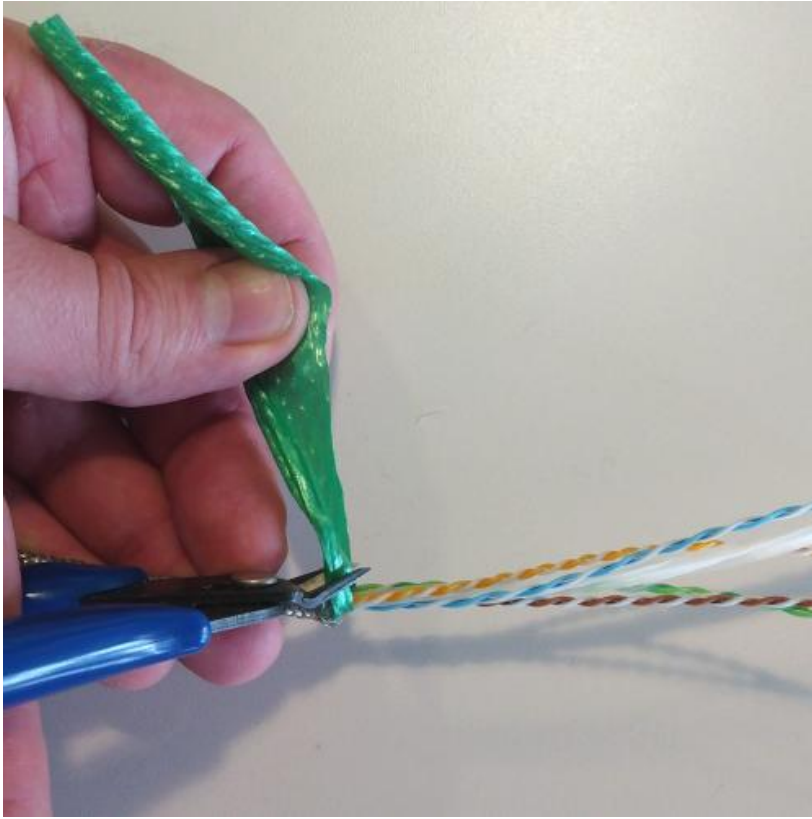

Remove and cut green wrap as shown.

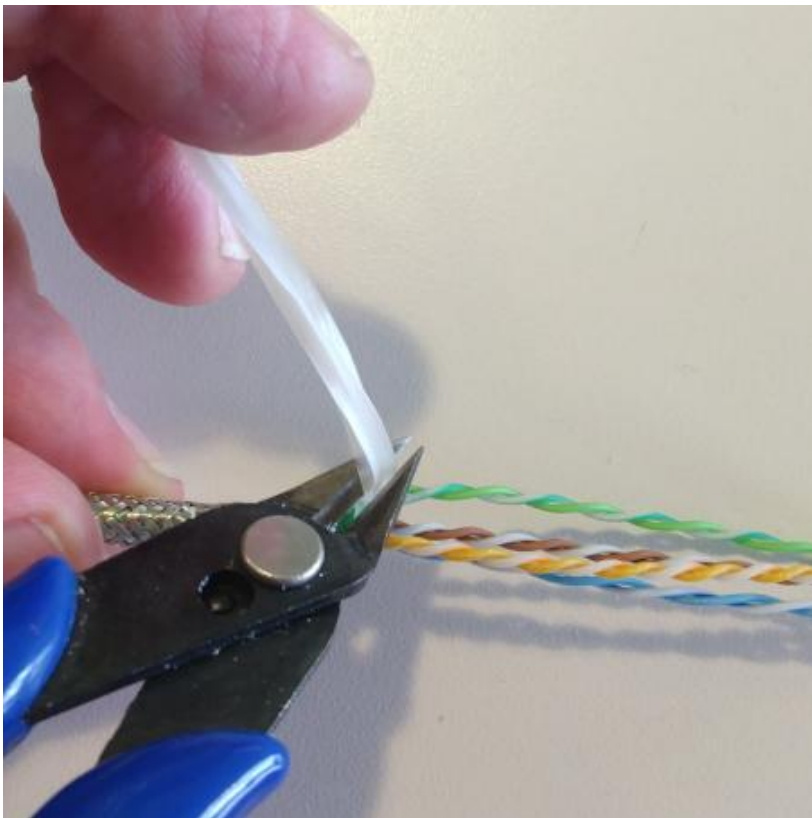

Separate plastic center core and carefully cut and remove.

CHAPTER 1

ROBOT BILL OF MATERIALS

- **STRUCTURAL COMPONENTS KIT**
 - These components are part of the AR4 build kit at <https://www.anninrobotics.com/robot-kits>
- **HARDWARE COMPONENTS KIT**
 - These components are part of the AR4 build kit at <https://www.anninrobotics.com/robot-kits>
- **ELECTRICAL COMPONENTS KIT**
 - These components are part of the AR4 build kit at <https://www.anninrobotics.com/robot-kits>
- **MOTORS AND DRIVERS PACKAGE FROM STEPPERONLINE**
 - These parts are available factory direct from Stepperonline as a discount package. There is a link to this package on the robot kits page.
- **3D PRINTED COMPONENTS**
 - These parts you need to print on your 3D printer (please see the overview section on 3D printed parts).

PLEASE ALSO REVIEW CHAPTERS 3 AND 4 TO MAKE SURE YOU HAVE THE COMPONENTS NEEDED FOR ANY GRIPPERS YOU MAY WANT TO INSTALL ON THE ROBOT.

DON'T FORGET TO REVIEW THE TOOLS AND MATERIALS SECTION IN THE OVERVIEW.



Structural Components



J1 BASE PLATE



J1 TURRET HOUSING



J1 SPINDLE

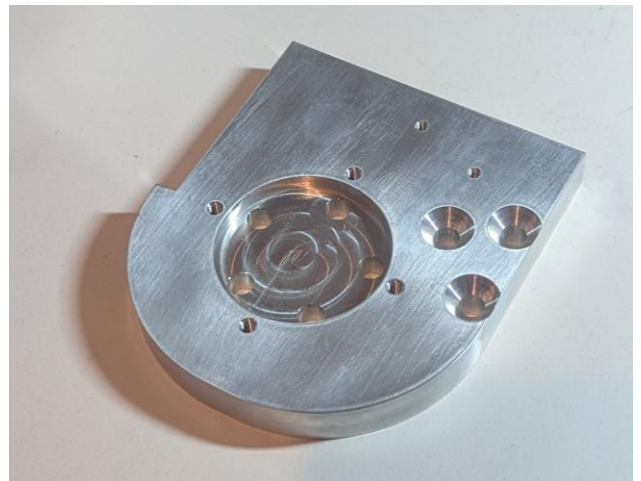

J1 PLATFORM





J2 TURRET HOUSING



J2 ARM



J2 DRIVE SPINDE



J2 TENSION RING



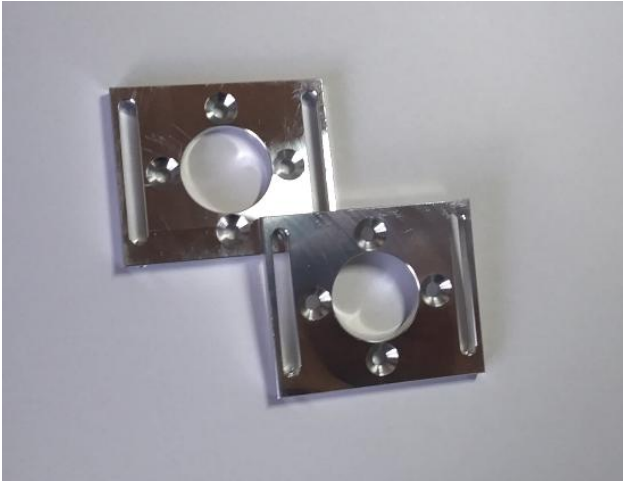

J1 & J3 MOTOR MOUNTS



J2 MOTOR SUPPORT



J3 BEARING CUP



J3 SPINDLE





J3 SPINDLE RETAINER



J4 TURRET HOUSING



J4 MAIN SHAFT

(see note below on making your own J4 main shaft if you are not using aluminum parts kit and are 3D printing your robot)



J5 MOTOR MOUNT



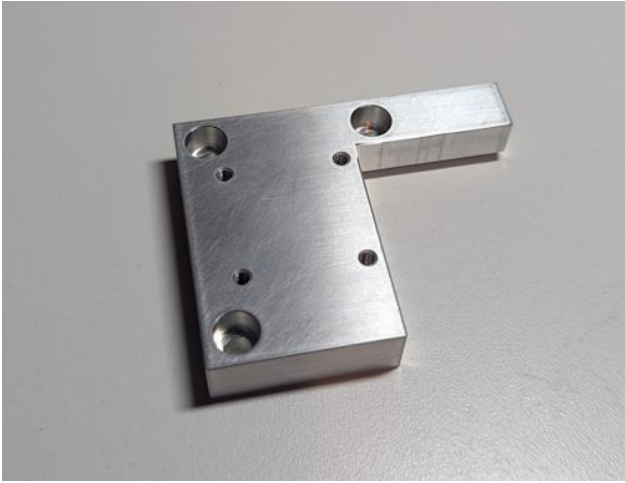

J4 MOTOR MOUNT



J5 BELT CARRIER



J5 HOUSING



J5 BELT CARRIER CLAMP





J5 IDLER TENSION BLOCK



J5 BEARING POST

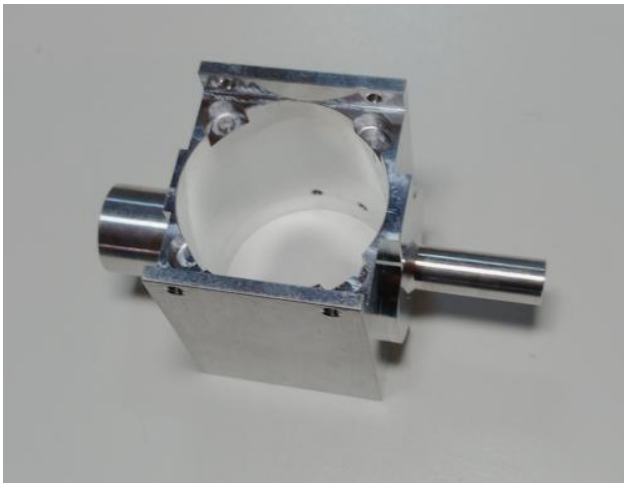

J6 HOUSING



J6 MAIN BEARING ARM





J6 GRIPPER MOUNT



J6 BEARING CAP



Hardware Components



Qty. (2) 32009 (45x75x20mm) taper roller bearing.



Qty. (2) 30206 (30x62x17.25mm) taper roller bearing.



Qty. (1) 30204 (20x47x15.25mm) taper roller bearing.



Qty. (1) AXK3552/AS3552 (35x52x4mm) thrust bearing with washers.



Qty.(3) NTA1625 (1.00x1.5625x0.0781 inch) thrust bearing.



Qty.(4) TRA1625 (1.000x1.5625x0.0312 inch) thrust washers.





Qty.(2) TRD1625 (1.000x1.5625x0.125 inch) thrust washers.



Qty.(2) B1616 (1x1-1/4x1 inch) needle roller bearing.



Qty. (1) HK1612 (16x22x12mm) needle roller bearing.



Qty.(2) 3mm x 85mm shaft.

(If sourcing the parts yourself these are typically sold in lengths of 100mm so you would need to cut them down to 85mm)



Qty.(2) 3mm ID x 7mm OD x 20mm long brass bushing.



Qty.(1) 688Z (8x16x5mm) groove ball bearing.





Qty.(1) 30203 (17x40x13.25mm) taper roller bearing.



Qty.(1) 60T XL pulley.

(If sourcing your own parts this can be purchased from Amazon or Servo City as a black phenolic material which works fine - there is also a 3D print file for this part)

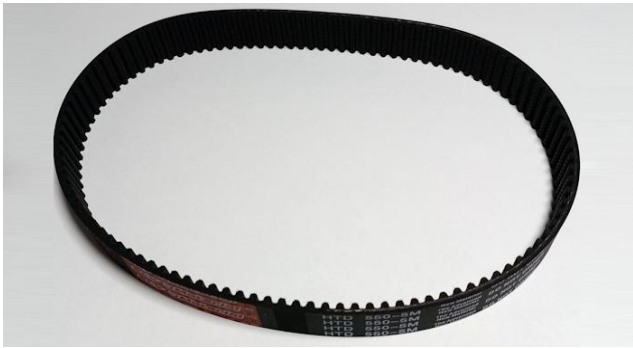

Qty.(1) HTD 550-5M belt.

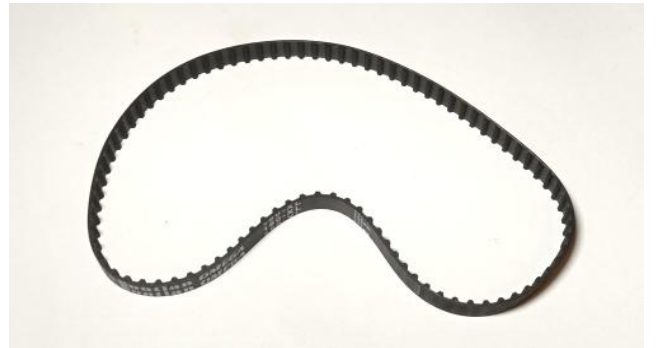

Qty. (1) 180XL037 belt.



Qty.(1) 150XL037 belt.



Qty.(1) 84XL037 belt.



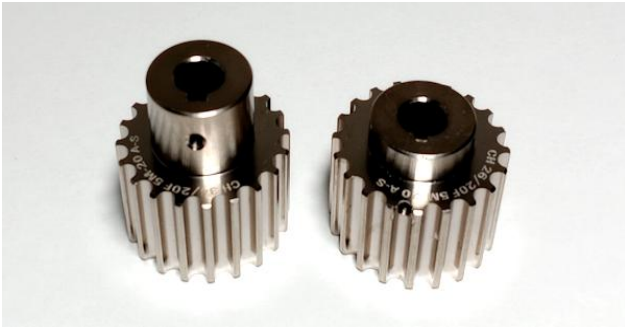

Qty (2) HTD-20 Pulleys (long and short)



Qty.(2) XL 15 tooth 8mm bore.

(one of them needs a 3mm key broach, the Annin Robotics hardware kit comes with a broached pulley but if you are sourcing your own parts they are not commonly broached for a key shaft)



Qty.(1) XL 10 tooth 6mm bore pulley



Qty.(1) 8mm keyed rotary shaft (you will need a length that is 50mm long)

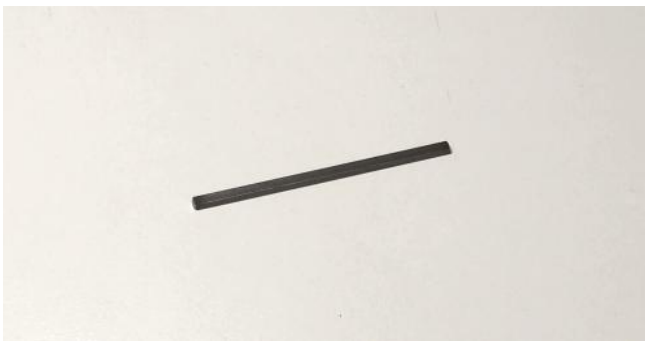

Qty.(1) – 2mm x 2mm keystick (you need a length 50mm long)



- ▶ Note on **J4 Main Shaft**: **If you are building a 3D printed robot** and do not have aluminum parts you will need to purchase a length of aluminum tubing, cut and drill as shown in this drawing. 1" OD .035" wall thickness tubing is available from McMaster Carr #1968T17 or can be sourced from other online metal supply retailers.

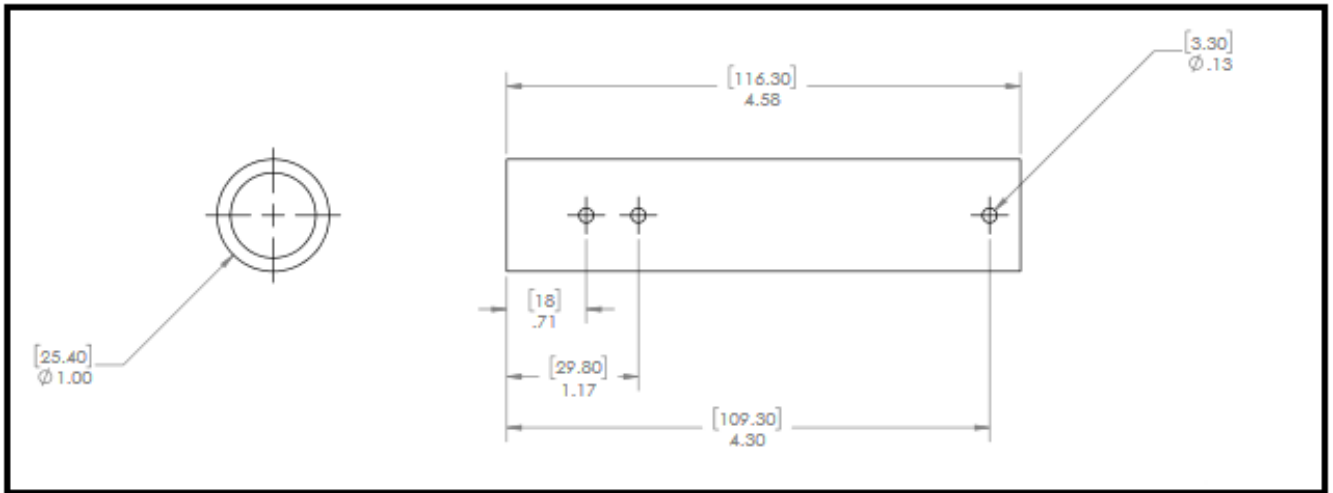

High-Strength 2024 Aluminum Tube

0.035" Wall Thickness, 1" OD



Length, ft.
✓ 1

Each

ADD TO ORDER

In stock
\$10.53 Each
1968T17

- ▶ Qty.(1) 1" OD aluminum tube (you need a length that is 116.3mm long) - *Sourced from McMaster Carr*
- ▶ You will need to purchase this part only if building a fully 3D printed robot – the aluminum parts kit comes with this tube

Machine Screws / Fasteners

#6 x .375 Thread Form Screw	26
M1.6x4 Pan Head Screw	6
M2.5 x 6 Pan Head screw	6
M2.5 x 8 Pan Head screw	6
M3 x 6 Button Head screw	1
M3 x 30 Pan Head screw	16
M3x10 Flat Head Screw	13
M3x10 Set Screw Screw	4
M3x10 Pan Head Screw	8
M3x14 Pan Head Screw	8
M3x14 Socket Head Screw	6
M3x16 Socket Head Screw	4
M3x20 Flat Head Screw	8
M3x20 Pan Head Screw	6
M3x25 Pan Head Screw	8
M3x3 Set Screw	5
M3x4 Set Screw	9
M3x6 Button head	1
M3x5 Set Screw	20
M3x5 Socket Head Screw	5
M3x6 Set Screw	7
M3x8 Socket Head Screw	5
M4 Nuts	4
M4 Washers	12
M4x10 Flat Head Screw	16
M4x10 Set Screw	12
M4x8 Pan Head Screw	3
M4x10 Socket Head Screw	16
M4x14 Flat Head Screw	2
M4x14 Socket Head Screw	1
M4x18 Flat Head Screw	6
M4x20 Pan Head Screw	2
M4x20 Socket Head Screw	8
M4x45 Pan Head Screw	4
M4x5 Set Screw	20
M6x14 Socket Head Screw	13
M6x18 Flat Head Screw	9
M6x20 Socket Head Screw	3
M8 x 14 Socket Head	2

Electrical Components



20awg flexible silicone wire in the following colors:

- Black
- Red
- Blue
- Green

3.2 meters of each color.



Continuous flex CAT5 or higher cable 26awg shielded.

(This needs to be stranded flex wire)

6.6 meters



Standard CAT5 or higher
cable.

(solid core wire is fine)

50cm



20awg 2 conductor black
and red wire..

37cm





1/4" braided sleeve.

3 meters



3/4" braided sleeve.

1.65 meters



PG-21 gland nut.

Qty (2)



EMI shielding tape 2.5cm
wide by 66cm long

USB-C 90 degree
Keystone Jack.

Qty(1)



Micro USB to USB-C cable
20cm long

Qty(1)



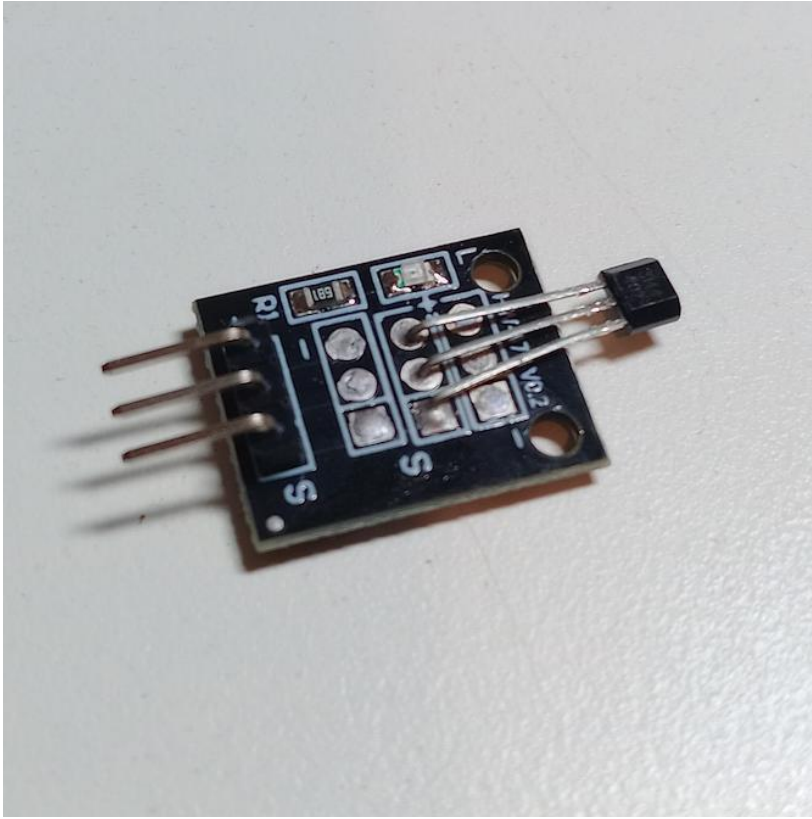

3144 Hall Effect Sensor
3.3v.
Qty (3)



10T85 Limit Switch
Qty (3)





4mm x 4mm round magnet
Qty (3)



Dupont 2.54 mm female 3
pin connector lead.
Qty(5)



5.5mm DC power jack socket.

Qty (1).



KCD1 SPST rocker switch.

Qty (1).



40mm 24vdc brushless cooling fan.

Qty (1).



PBS-110 push button switch

Qty (1).



Teensy 4.1 (with pins)
Qty (1).



Terminal Block Breakout
Board Module - Teensy 4.1
Qty (1).

2x12 power distribution terminal block.



3D Printed Components

You will need to 3D print the robots covers and spacers. See downloads page <https://www.anninrobotics.com/downloads> for .stl print files. See overview section notes on 3D printed parts. In this build I have used Silver, Grey and Blue filament. PETG is recommended wherever possible.

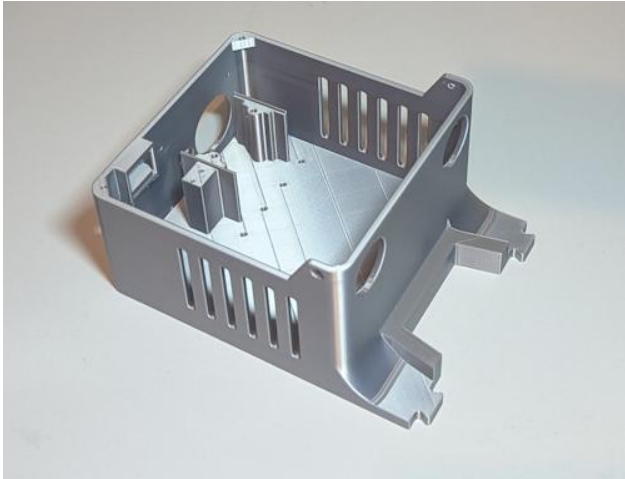

J1 BASE ENCLOSURE REAR

Please note: there is also a print file available in the large parts print folder for a single piece base enclosure.

SILVER FILAMENT 15% INFILL 2X WALLS



J1 BASE ENCLOSURE FRONT

Please note: there is also a print file available in the large parts print folder for a single piece base enclosure.

SILVER FILAMENT 50% INFILL 4X WALLS



J1 BASE ENCLOSURE TRAY

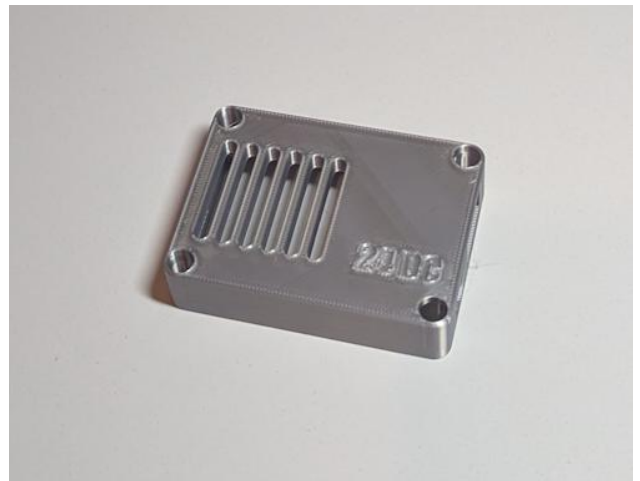

J1 BASE ENCLOSURE FAN COVER

SILVER FILAMENT 15% INFILL 2X WALLS

SILVER FILAMENT 15% INFILL 2X WALLS



J2 SIDE COVER

BLUE FILAMENT 15% INFILL 2X WALLS



J1 ENCLOSURE LID

SILVER FILAMENT 15% INFILL 2X WALLS



J2 ARM COVER SPACER

BLUE FILAMENT 15% INFILL 2X WALLS

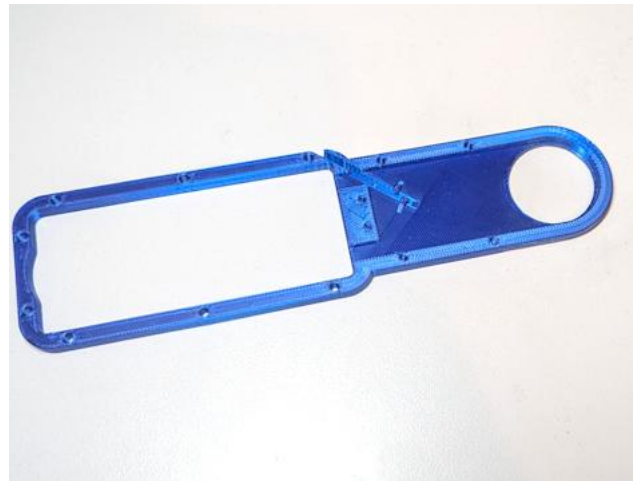

J5 SIDE PLATE

BLUE FILAMENT 15% INFILL 2X WALLS





J5 SIDE COVER

BLUE FILAMENT 15% INFILL 2X WALLS



J5 SIDE SPACER

BLUE FILAMENT 15% INFILL 2X WALLS





J2 SPACER PARTS 1 & 2

BLACK FILAMENT 50% INFILL 4X WALLS

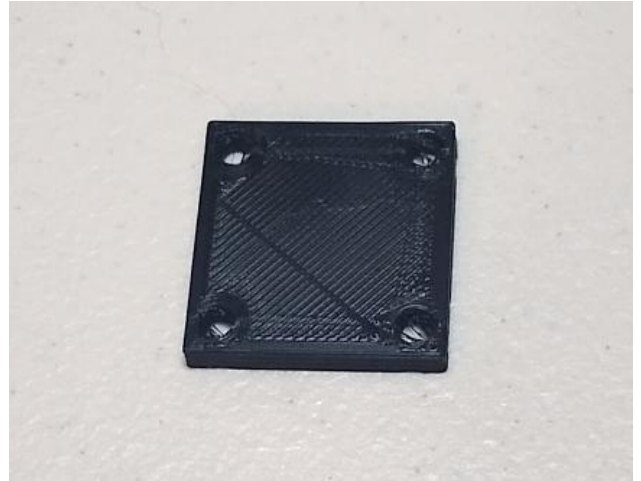

J4 MOTOR SPACER – 4mm

BLACK FILAMENT 15% INFILL 2X WALLS



J5 Bearing Post Spacer

BLACK FILAMENT 15% INFILL 2X WALLS



J4 Timing Hub

BLACK FILAMENT 50% INFILL 4X WALLS





J1 Magnet Mount

BLACK FILAMENT 15% INFILL 2X WALLS



J2 Bearing Cover

BLACK FILAMENT 15% INFILL 2X WALLS

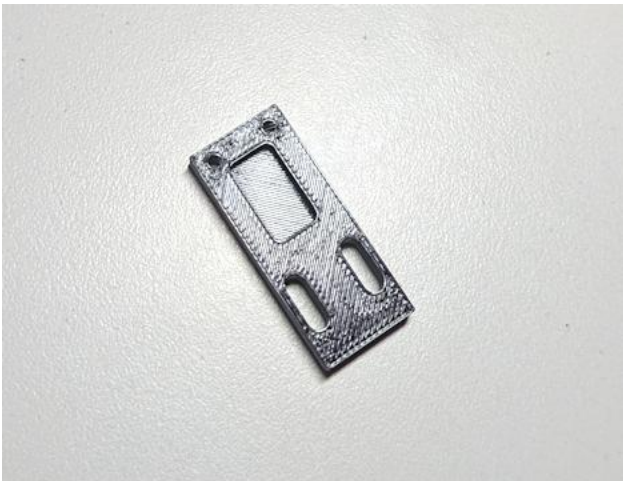

Sensor Mount 1

BLACK FILAMENT 15% INFILL 2X WALLS



Sensor Mount 2

BLACK FILAMENT 15% INFILL 2X WALLS





J2 Magnet Mount

BLACK FILAMENT 15% INFILL 2X WALLS



Sensor Mount 3

BLACK FILAMENT 15% INFILL 2X WALLS



J2 Cable Holder

BLACK FILAMENT 15% INFILL 2X WALLS





J4 Limit Switch Mount

BLACK FILAMENT 15% INFILL 2X WALLS



J2 ARM COVER LOGO & J5 ARM COVER LOGO

WHITE FILAMENT 15% INFILL 2X WALLS

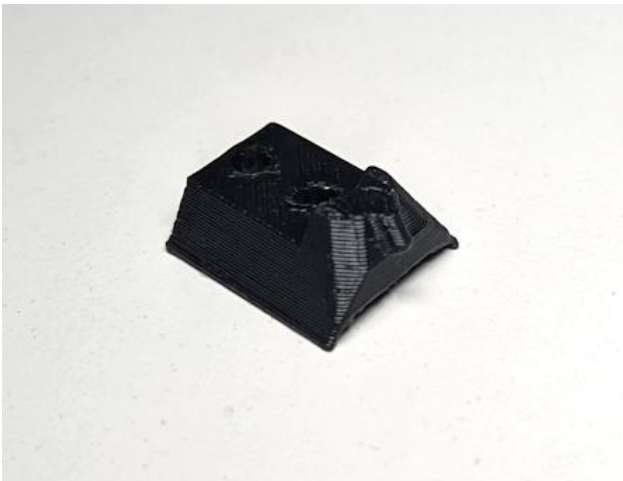

J6 Limit Contact

BLACK FILAMENT 15% INFILL 2X WALLS



J6 Limit Switch Mount

BLACK FILAMENT 15% INFILL 2X WALLS





CF Cat6 Jacket Stripper

This is a tool you can print to assist in removing the outer jacket of the continuous flex Cat6 cable.



J5 Motor bracket

BLACK FILAMENT 15% INFILL 2X WALLS



Stepper Motors & Drivers

All motors are available from Stepperonline. There is a link on the robot kits page to a complete discounted motor, driver and power supply kit from Stepperonline.

<https://www.omc-stepperonline.com/>



J1 gear head motor

SKU: 17HS15-1684D-EG10-AR4

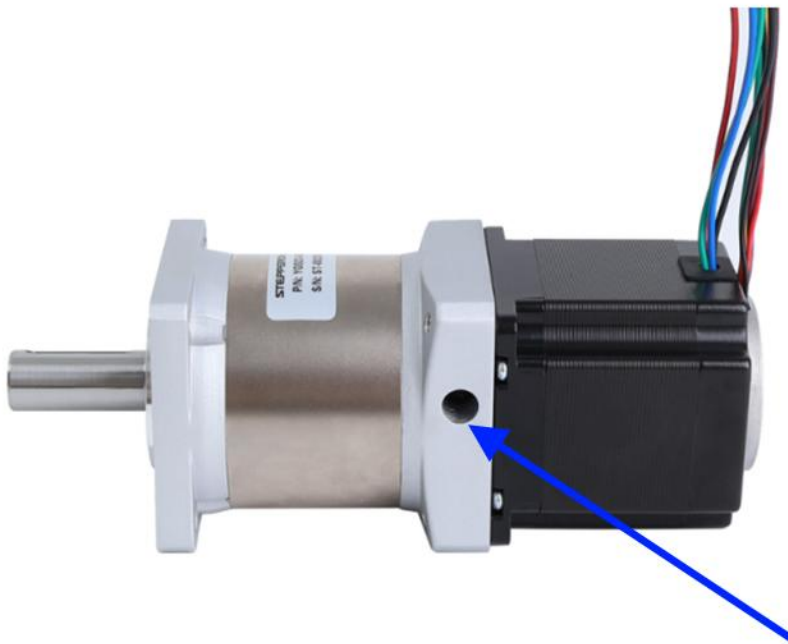

J2 gear head motor

SKU: 23HS22-2804D-YGS50-AR4

NOTE: CHECK AND MAKE SURE THE MOTOR TO GEARBOX COUPLER IS TIGHT. REMOVE THE SMALL PLASTIC PLUG ON THE SIDE OF THE GEARBOX AND USE A HEX KEY WRENCH TO MAKE SURE THE COUPLER INSIDE IS TIGHT.





J3 gear head motor
SKU: 17HS15-1684D-
EG50-AR4



J4 gear head motor
SKU: 11HS20-0674D-
EGS16-AR4

J5 linear drive motor
17LS19-1684E-200G-AR4

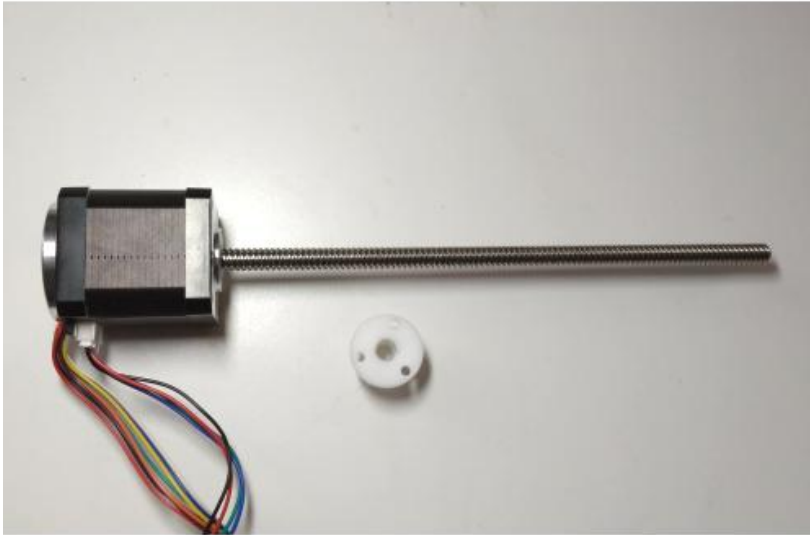

Note: the motor lead screw comes with a POM nut which can be black or white depending on production.

Make sure to remove POM nut from lead screw prior to assembly.



J6 gear head motor
SKU:14HS11-1004D-EGS20-AR4

NOTE: MAKE SURE TO REMOVE GEARBOX DECAL AND ALL RESIDUE BEFORE INSTALLING MOTOR

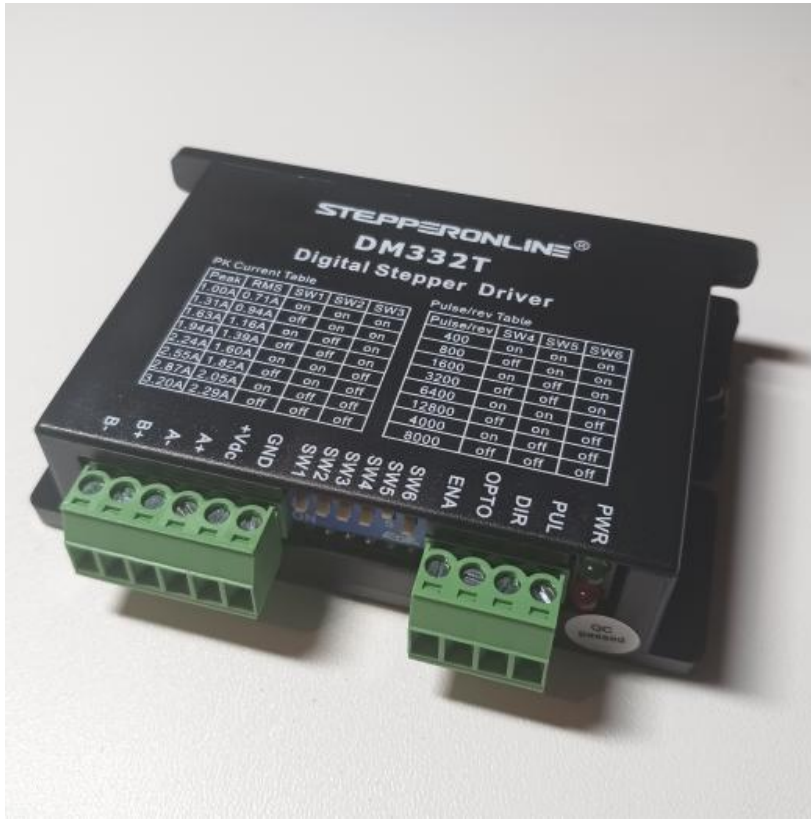

DM332T digital stepper driver.

You will need (3) of these drivers for axis 1,2,3, of the robot.

Drivers and motors are available factory direct from Stepperonline. (see link on robot kits page).

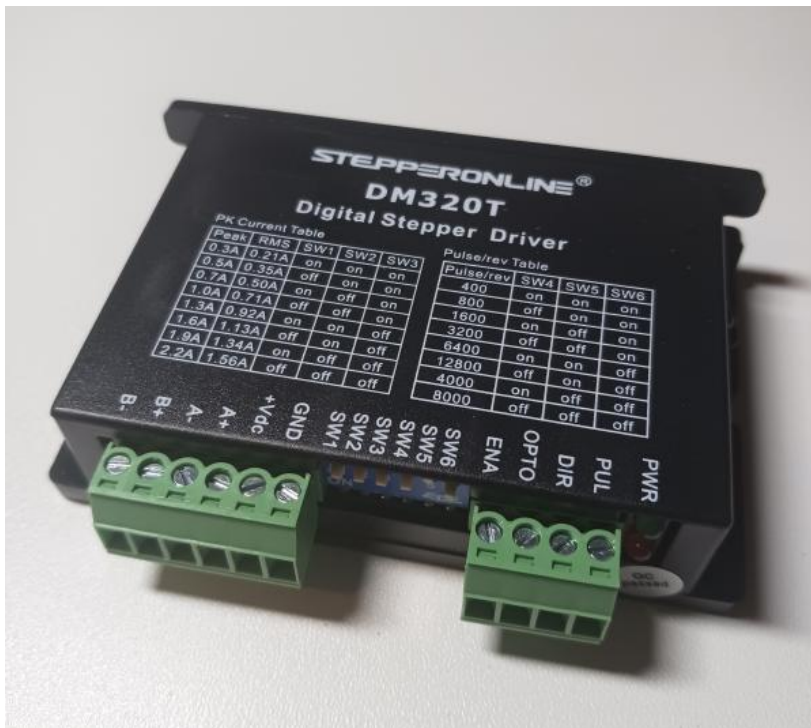

DM320T digital stepper driver.

You will need (3) of these drivers for axis 4,5,6, of the robot.

Drivers and motors are available factory direct from Stepperonline. (see link on robot kits page).



**Nema 11 Bracket for Stepper Motor
Steel Bracket**

★★★★★ 0 reviews | Write a review

SKU: ST-M3

\$1.96

(1) Bracket for the J4 motor

#SKU: ST-M3

CHAPTER 2

ROBOT ASSEMBLY INSTRUCTIONS





Carefully remove all build structure from the J1 BASE ENCLOSURE. Use 3mm drill to clear or clean out the (6) holes in the bottom of the enclosure.

Please note: there is also a print file available in the large parts print folder for a single piece base enclosure.



Use 3mm drill to clear or clean out the (4) holes on the rear side of the enclosure (yellow arrows).



Remove 3D print build structure from counterbore holes on both sides of base enclosure, and the clean or clear center of hole with 3.5mm drill.



Partially screw in (6) of the #6 thread form screws as shown. Only screw them in a couple threads for now.



Place #6 thread form screw in to the left side slot of the DM332T driver as shown and then lower the drive into position.

NOTE: The screw can be held in position with Phillips head screw driver as its lowered down into position.

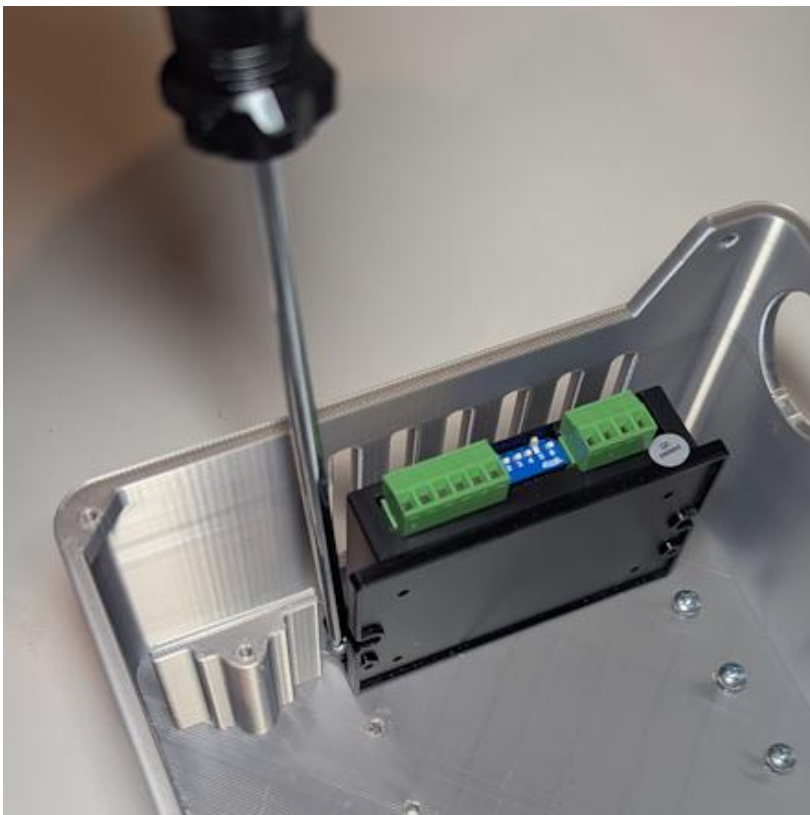

Use Phillips head screw driver to snug the left side screw as the driver is maneuvered into position.

Then snug the screw on the right side of the DM332T driver.

NOTE: be careful not to overtighten screws.



Repeat this process for the remaining (2) DM332T drivers as shown.

NOTE: The (3) DM332T drivers should be installed on the left side of the enclosure as shown in the photo.

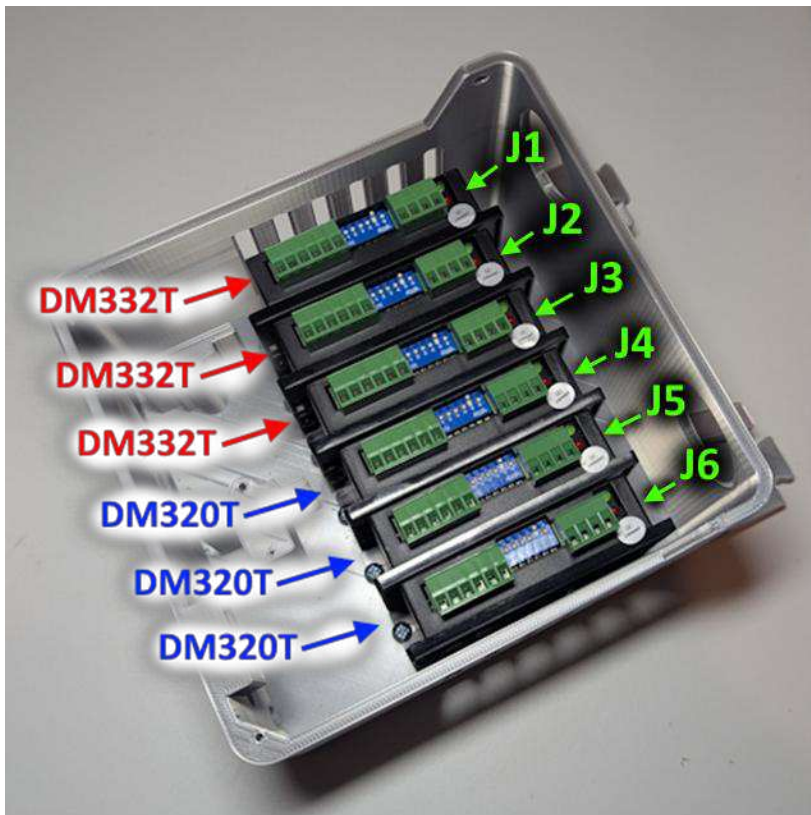

Repeat the driver installation process for the (3) DM320T drivers as shown.

NOTE: The (3) DM320T drivers should be installed on the right side of the enclosure as shown in the photo.

DIP SWITCH SETTINGS

Set each drives dip switches as outlined below:

• J1 - 17HS15-1684D-EG10	800 micro step	1.82 AMP
• J2 - 23HS22-2804D-HG50	800 micro step	2.29 AMP
• J3 - 17HS15-1684D-EG50	800 micro step	1.82 AMP
• J4 - 11HS20-0674D-EGS16	800 micro step	0.50 AMP
• J5 - 17LS19-1684E-200G-C1	1600 micro step	1.56 AMP
• J6 - 14HS13-0804D-PG19	800 micro step	0.92 AMP



J1 – (DM332T):

SW1 = OFF SW2 = ON SW3 = OFF SW4 = OFF
SW5 = ON SW6 = ON

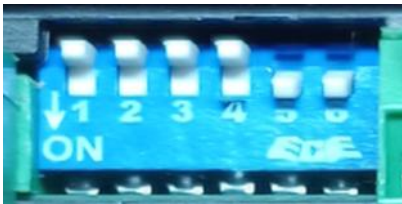

J2 – (DM332T):

SW1 = OFF SW2 = OFF SW3 = OFF SW4 = OFF
SW5 = ON SW6 = ON



J3 – (DM332T):

SW1 = OFF SW2 = ON SW3 = OFF SW4 = OFF
SW5 = ON SW6 = ON

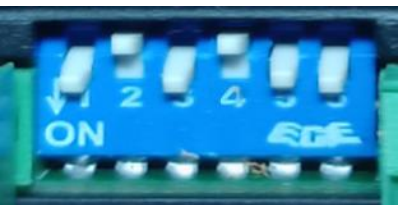

J4 – (DM320T):

SW1 = ON SW2 = OFF SW3 = ON SW4 = OFF
SW5 = ON SW6 = ON



J5 – (DM320T):

SW1 = OFF SW2 = OFF SW3 = OFF SW4 = ON
SW5 = OFF SW6 = ON

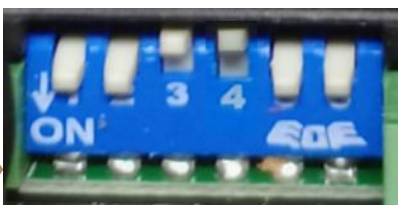

J6 – (DM320T):

SW1 = ON SW2 = ON SW3 = OFF SW4 = OFF
SW5 = ON SW6 = ON

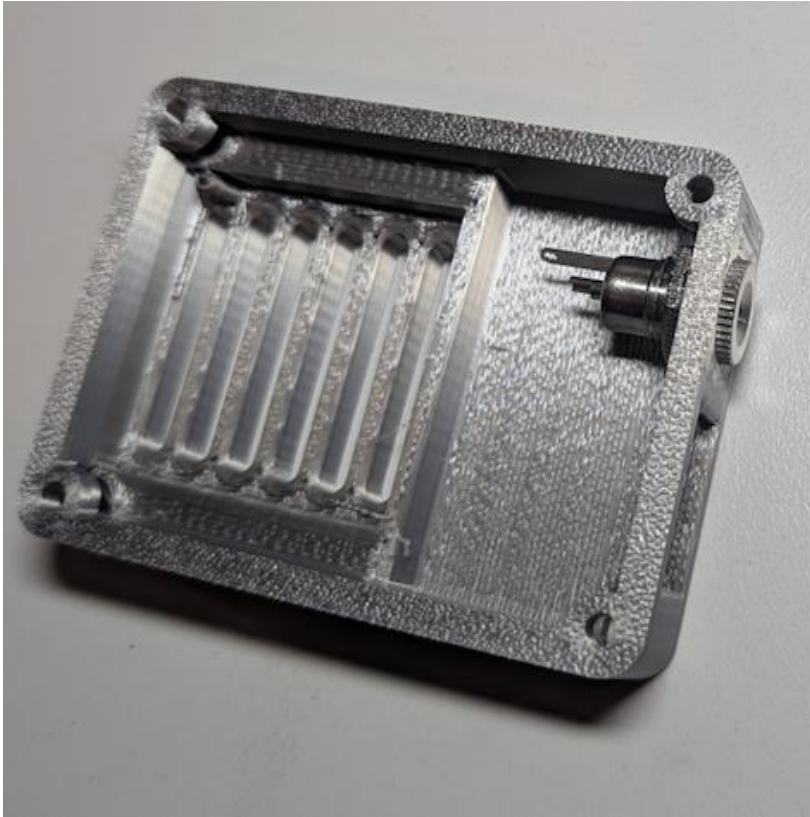

Remove all build structure from 3D printed Base Enclosure Fan Cover then install the 5.5mm power jack as shown.

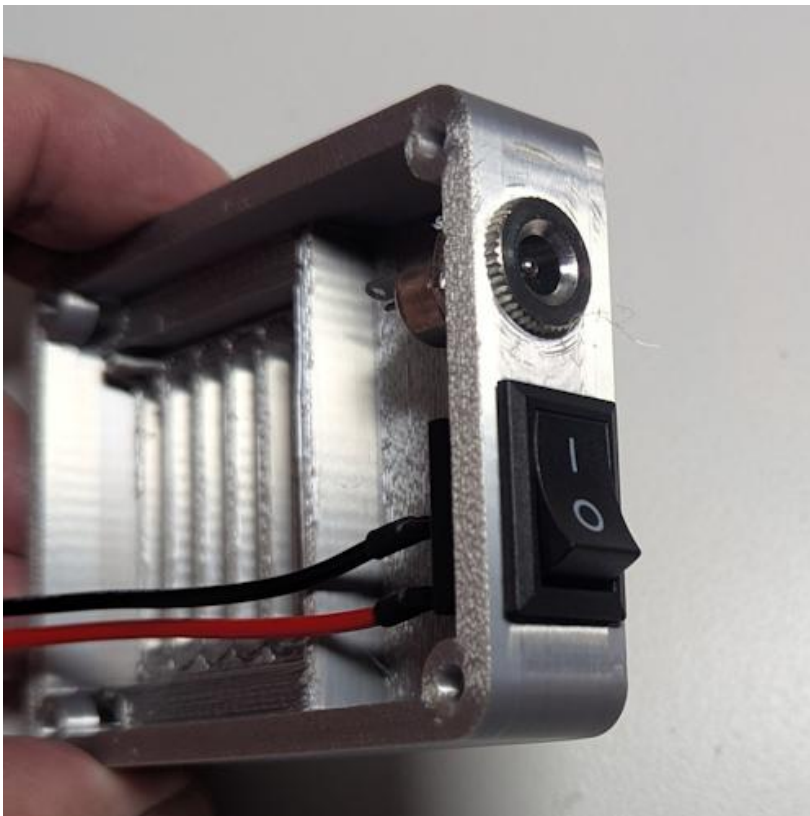

Install rocker switch as shown. Rocker switch will snap into position.

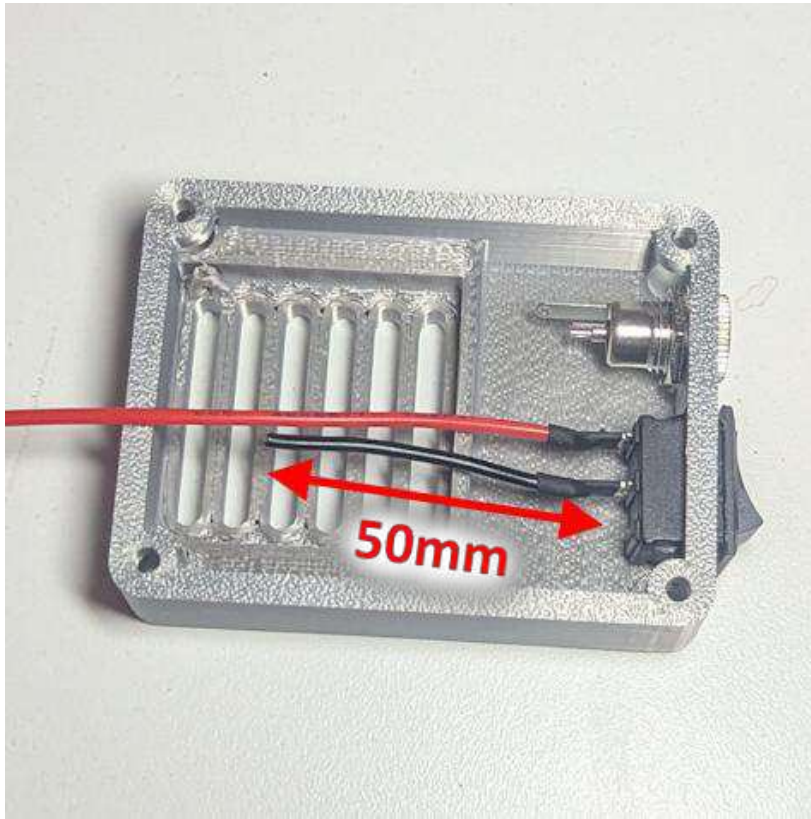

Cut the rocker switch black wire as shown leaving 50mm of wire extended from the rocker switch.

Save the remainder wire for the next step.

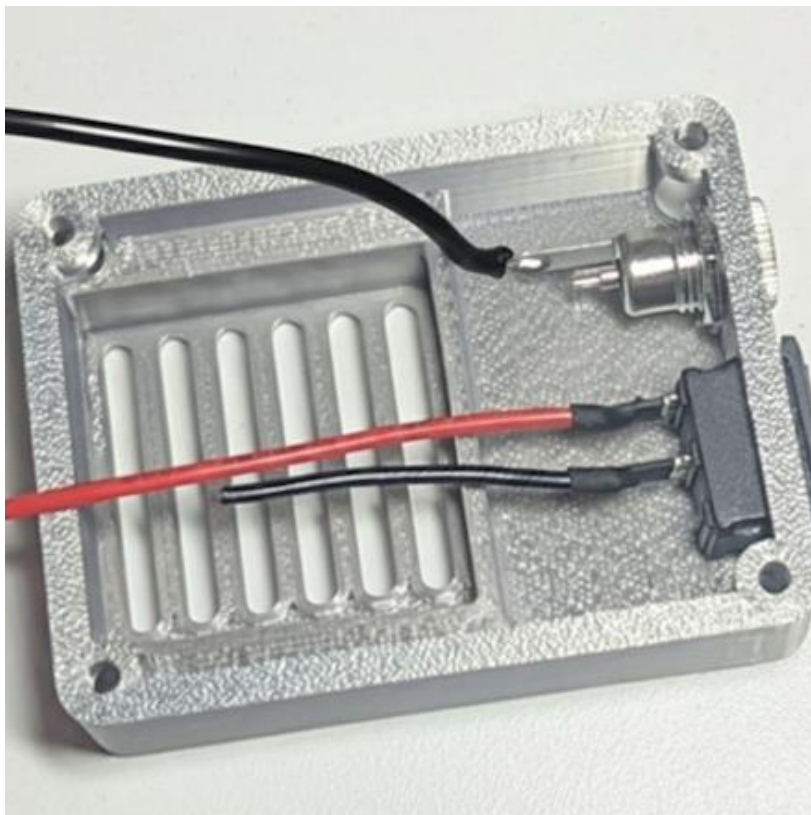

Strip 3mm of sheathing from the end of the black 13cm long 20awg wire and then solder the wire to the 5.5mm power sockets ground connection tab as shown.

NOTE: The ground connection tab is the longer tab coming from the socket outer housing as shown.

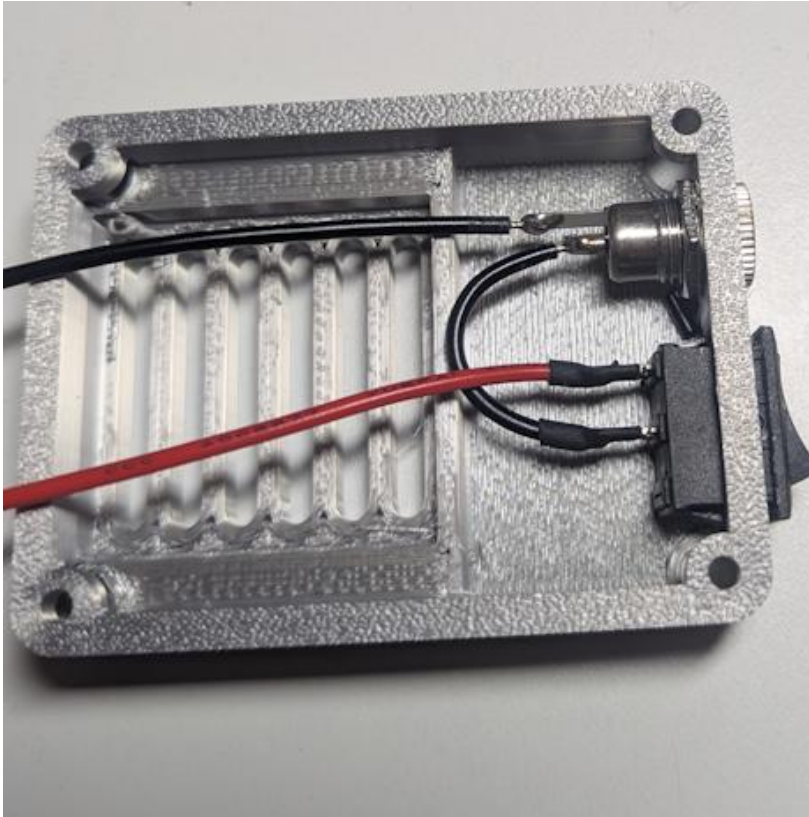

Remove 3mm of sheathing from the rocker switch black wire and then solder the rocker switch black wire to the positive center terminal on the 5.5mm power jack as shown.

NOTE: the positive terminal is the one in the center of the power jack. Make sure solder connections to each of the power jack terminals are solid and that there are no stray strands of wire and that there are no possibilities of a short between the power jack terminals.

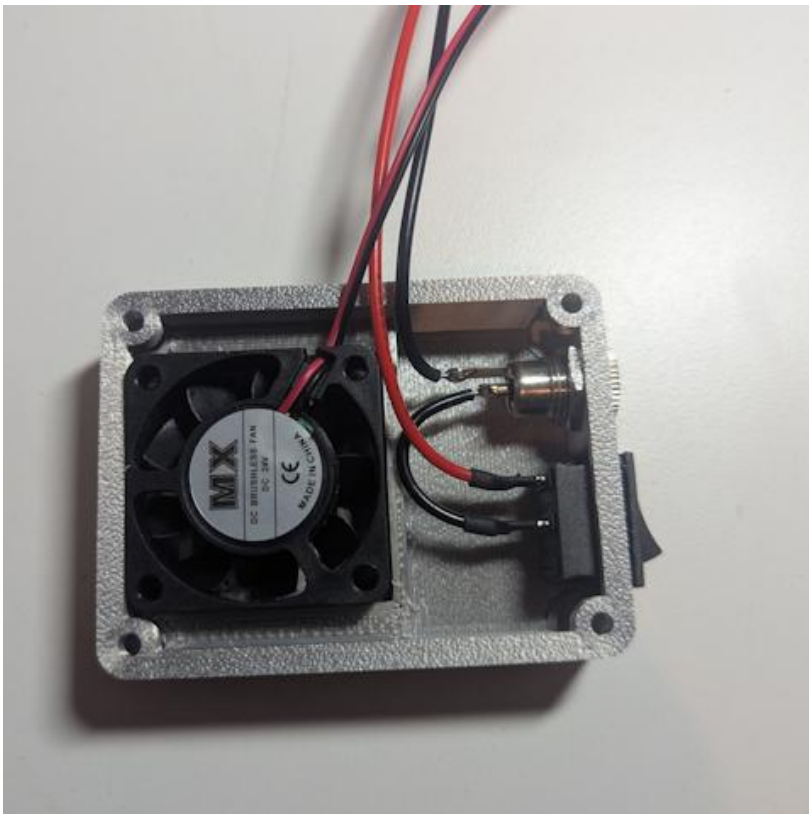

Insert 40mm cooling fan into housing as shown. The fan label should be facing out.

NOTE: The fan is a snug slip fit into housing and is not secured with any fasteners.

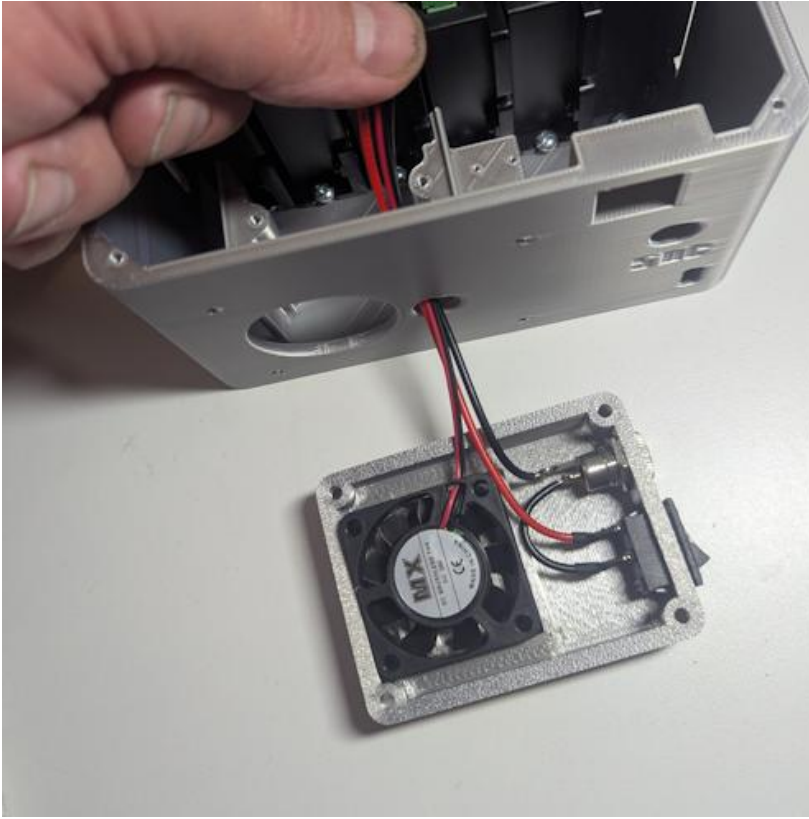

Feed the red and black power wires as well as the cooling fan wires through the base enclosure access hole as shown.

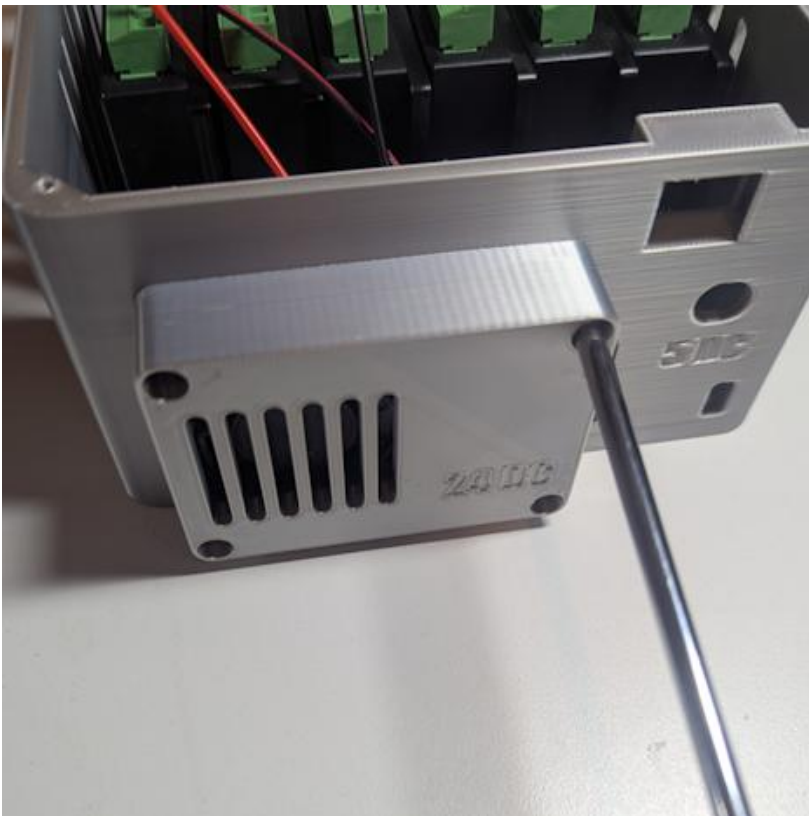

Secure fan enclosure to the base enclosure as shown using (4) #6 plastic thread form screws.



Cut (5) pairs of red and black 20awg wires.

The wires should be 48mm in length.

Strip 3mm of sheathing from the ends of each wire.



Use the (5) pairs of wires to jumper the +Vdc and GND circuit across all 6 drivers as shown.

NOTE: the green connection socket to the drivers will need to be pulled out one at a time to insert wires and tighten the terminal screws.

The driver on the far left is for J1 and the driver on the far right is for J6



Connect the red and black power wires from the fan enclosure to the power and GND terminals on the first drive as shown in the photo.

This will supply power to the first drive which then daisy chains the power across to all 6 drives.

NOTE: the green connection socket to the driver will need to be pulled out to insert wires and tighten the terminal screws.

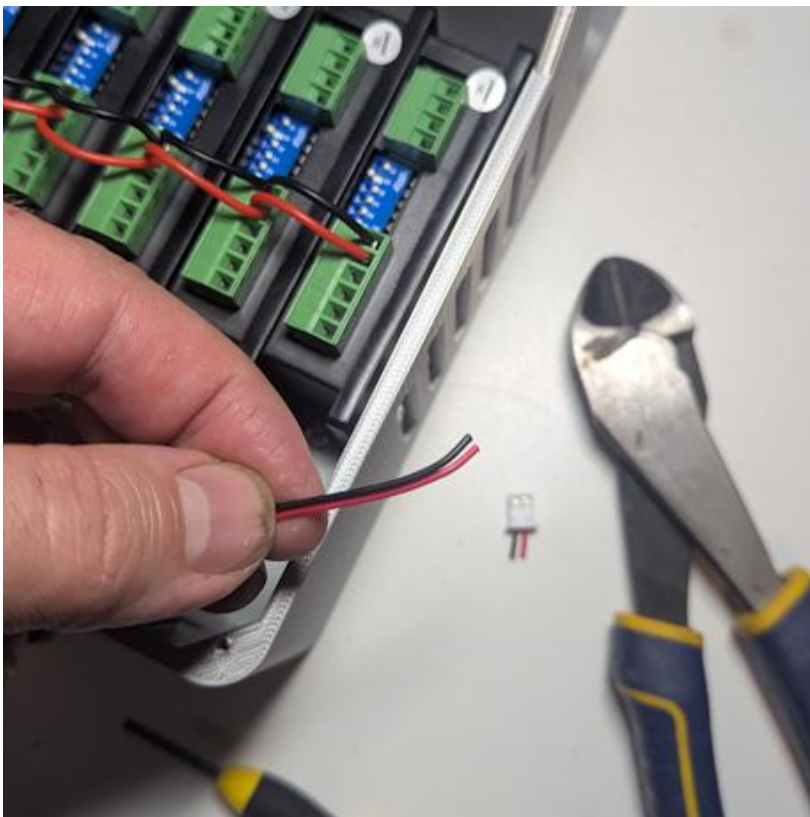

Cut off the cooling fan wire connector as shown.

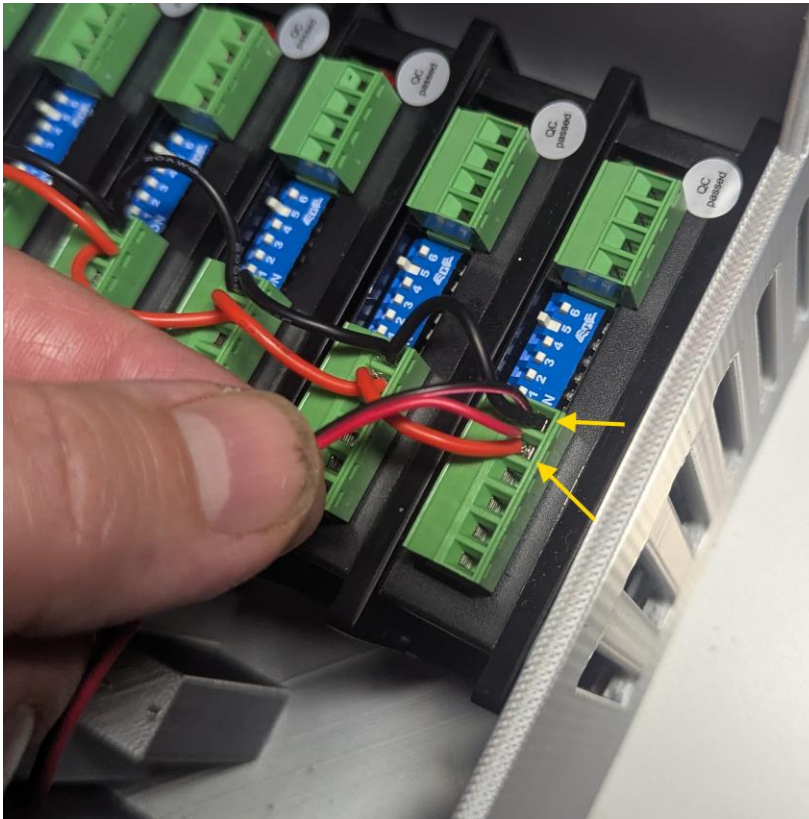

Strip fan wire ends and then connect the red and black wires from the fan to the power and GND terminals on the last driver as shown in the photo.

This will supply power to the fan when the drives are powered on.

NOTE: the green connection socket to the driver will need to be pulled out to insert wires and tighten the terminal screws.

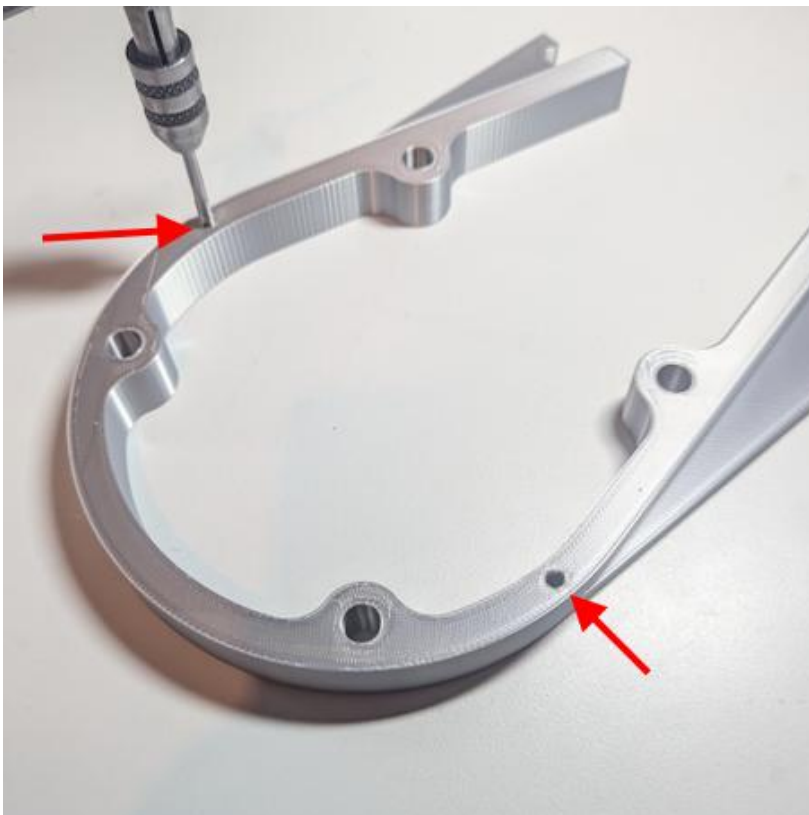

Use a 3.3 to 3.5mm drill to clear out the 2 holes in the J1 Base Enclosure Front.

Then use M4 tap to thread (2) holes as shown in J1 base enclosure.



Secure J1 base plate to J1 enclosure front using (2) M4x20 pan head machine screws.

NOTE: these screws are meant to hold base plate to enclosure for assembly and transport purposes only – when assembly is complete and you are ready to use your robot you will need to secure robot to table or work surface using 8mm fasteners through (4) mounting holes.

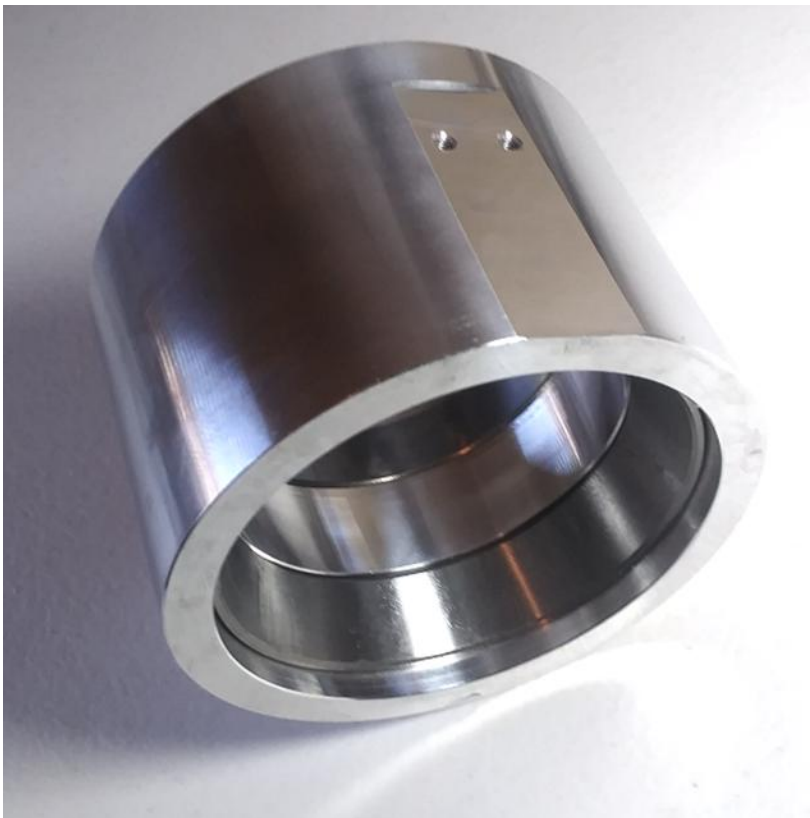

Press (x2) #32009 bearing races into the J1 turret housing. (you will need to do this for both races one at a time)

(See notes on bearing fit in overview section)



Install and tighten M6x14
Cap screw into J1 spindle
as shown.



Install #32009 bearing on J1
spindle as shown.

*Note: Apply a thin film of
white lithium grease to the
bearing.
(grease not shown in photo)*

***(See notes on bearing fit in
overview section)***



Insert J1 spindle into turret housing then install the other #32009 bearing on top side of spindle.

*Note: Apply a thin film of white lithium grease to the bearing.
(grease not shown in photo)*



Place 4mm x 4mm magnet on the tip of a flat blade screwdriver as shown.

Hold the magnet up to a magnet polarity tester and make sure the North side of the magnet is facing out and that the south side is connected to the screwdriver.

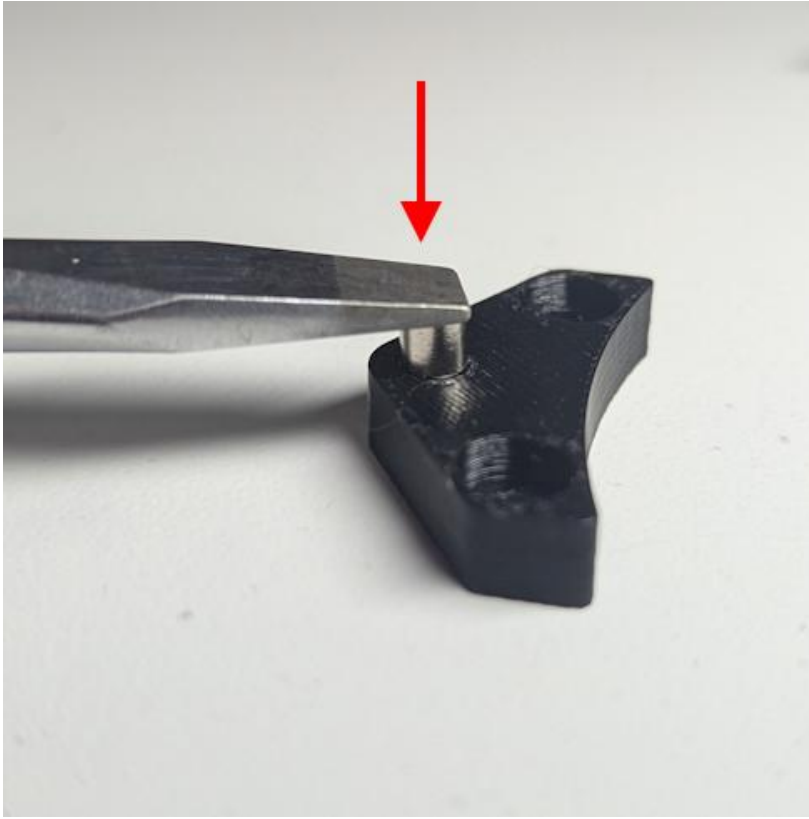

Using flat blade screw driver, press magnet into 3D printed J1 Magnet Mount.



Use magnet polarity tester to verify the South side is facing out.



Secure J1 Magnet mount to the J1 Platform as shown using (2) M3x10 pan head screws.

NOTE: MAKE SURE SOUTH POLE OF MAGNET IS FACING UP

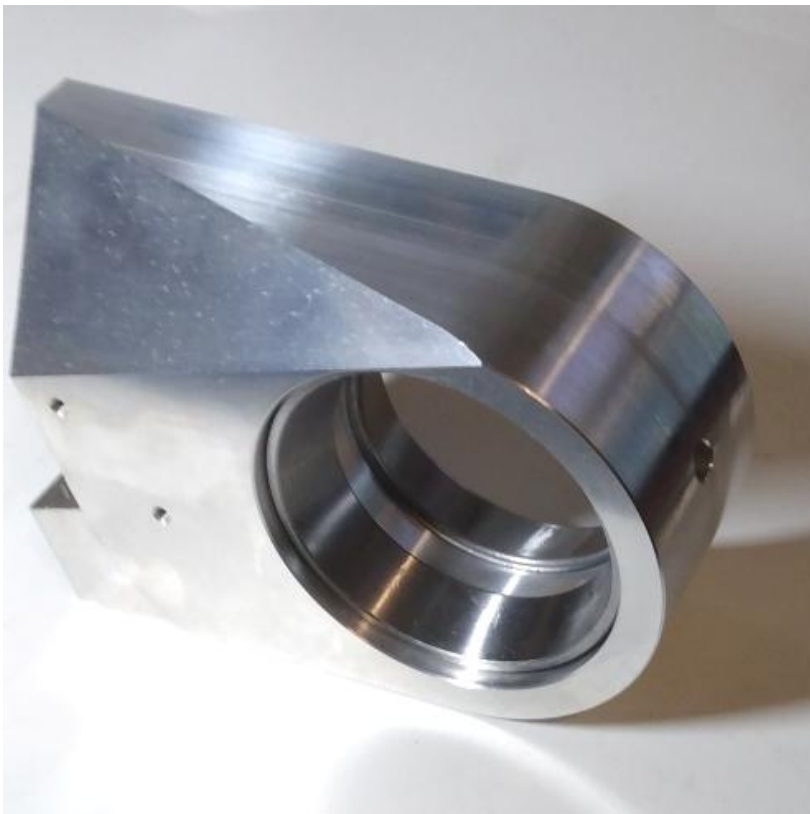

Press (x2) #30206 bearing races into the J2 turret housing. (you will need to do this for both races on each side)

(See notes on bearing fit in overview section)

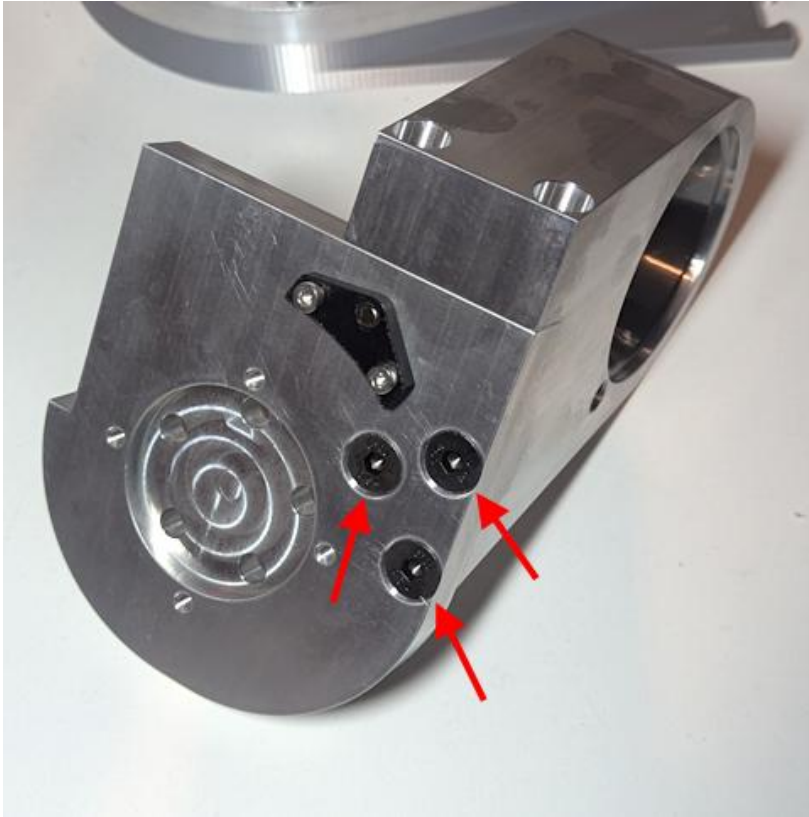

Secure J2 turret housing to J1 platform using (3) M6x18 flat head screws.

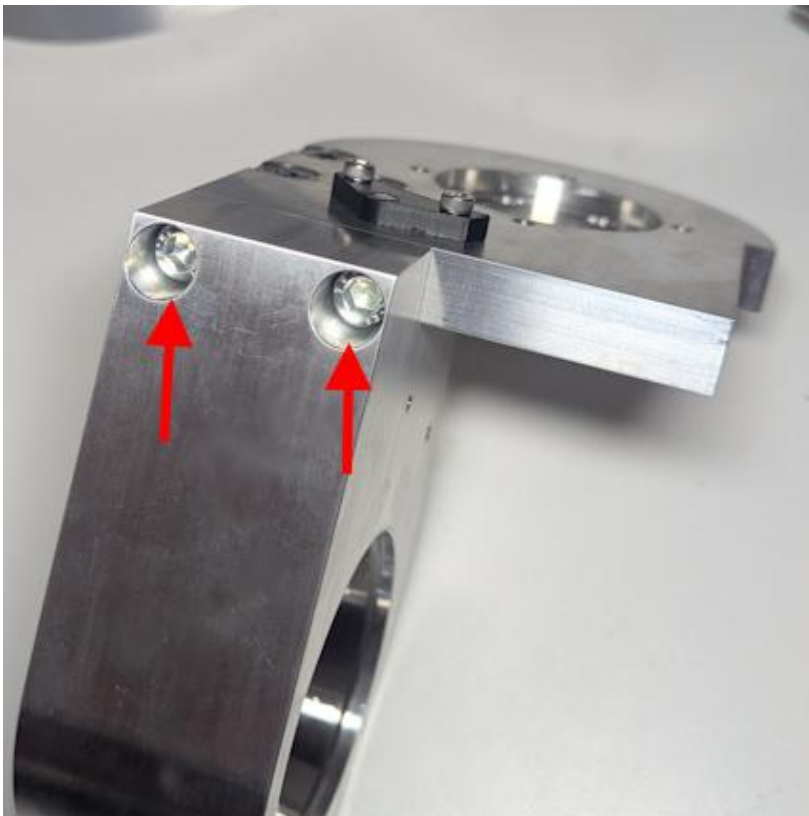

Install (2) M6 x 20 socket head screws in front of J2 turret housing going into the J1 platform.



Install platform assembly onto J1 spindle assembly and secure with (5) M6 X 14 socket head cap screws.

NOTE: see next step to verify alignment

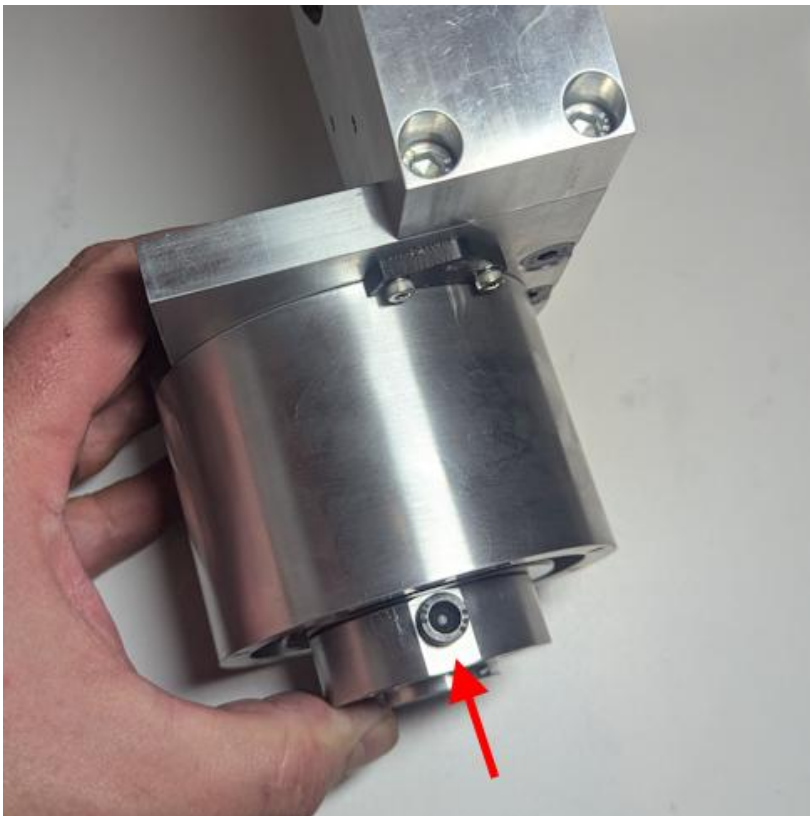

Make sure that the cap head screw on the J1 spindle is facing forward as shown with the J1 platform secured to the spindle as shown in the photo.

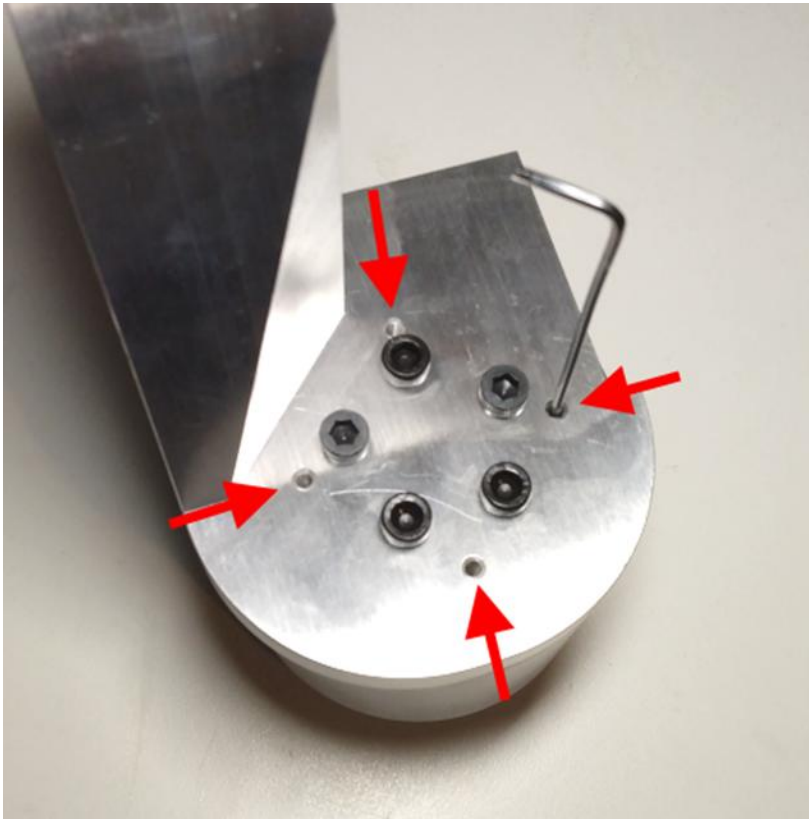

Install (4) M4 x 10 set screws in the 4 perimeter holes in the platform.

These place tension on the upper bearing.

Snug the 4 set screws down evenly until there is no play in the bearings.

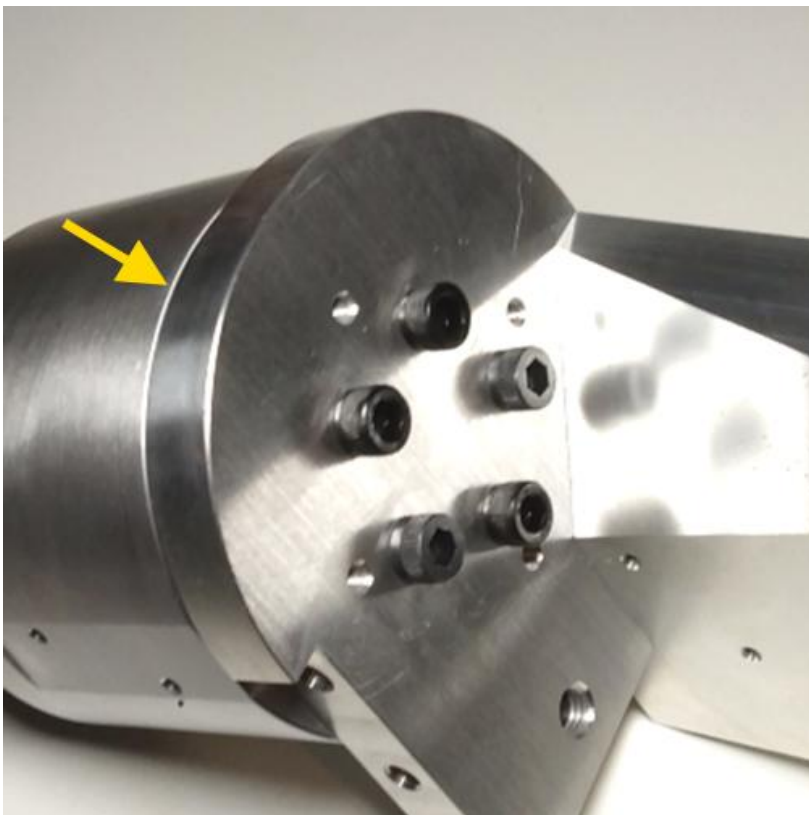

Please note that the J1 spindle and platform should rotate freely.

The gap between the J1 platform and the J2 housing (yellow arrow) is meant to be a tight or thin gap to prevent contaminants from easily getting into the bearing area.

In some cases tolerance stack up can result in slight rubbing between platform and housing.



If you experience any rubbing you can remove the J1 platform and install a .1mm shim between the spindle and platform. In the example shown an aluminum circle was cut from the side of an aluminum can that fits concentrically inside the M6 bolt pattern and then reassemble.

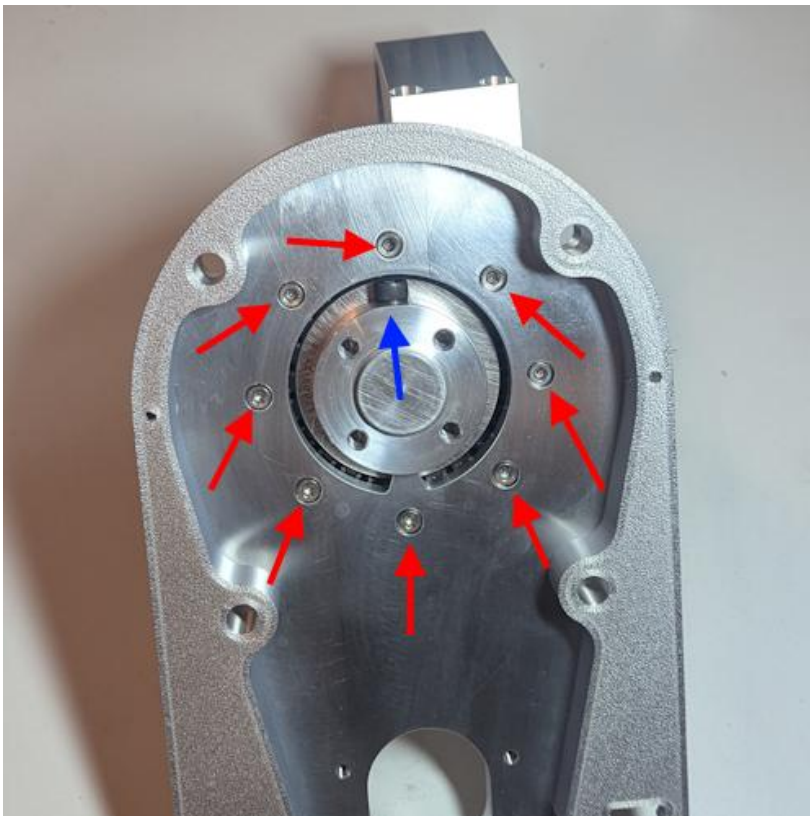

Secure J1 turret assembly to J1 base from the bottom using (8) M4x10 socket head cap screws (red arrows).

Make sure the J1 spindle cap screw is facing upward as shown (blue arrow).

Note orientation of limit switch flat in next step prior to installing.



Make sure limit switch flat is facing toward rear as indicated by red lines in this image.

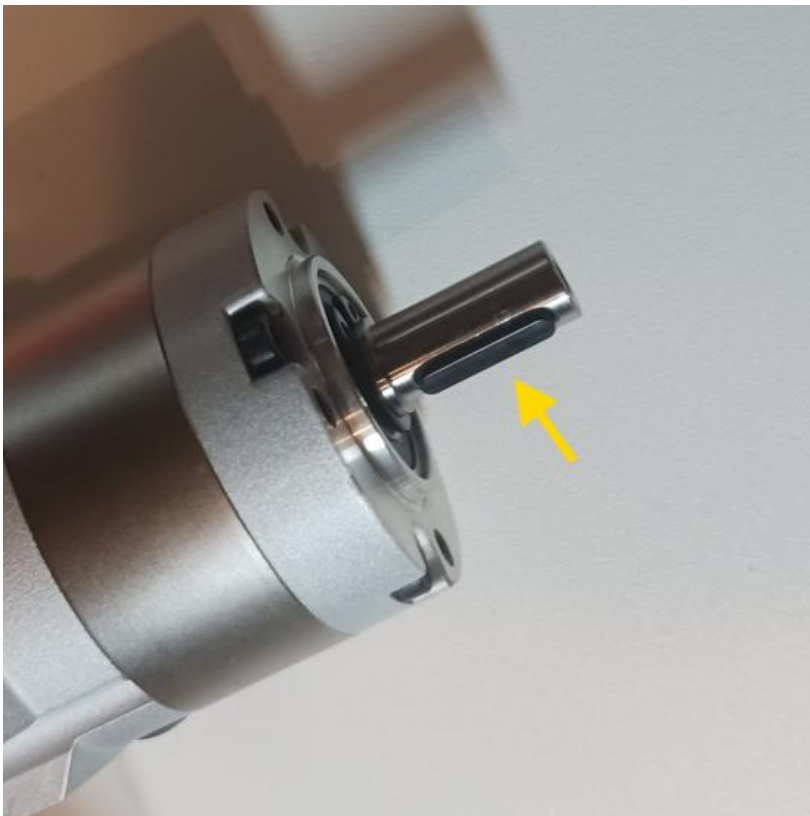

Install 3mm key into J1 (SKU: 17HS15-1684D-EG10-AR4) motor shaft as shown.

The motor keys are sometimes shipped uninstalled in a small zip bag supplied with the motor paperwork and manuals.

Verify Key is fully inserted in motor shaft.



Secure J1 motor mount to J1 motor using (4) M4x10 flat head screws.

Make sure the motor wires are oriented on the right side as shown (yellow arrow) and that the J1 motor mount tension holes are facing toward you (red arrows).

MAKE SURE YOU ARE INSTALLING THE J1 MOTOR AND NOT THE J3 MOTOR. IT HAS BEEN A COMMON MISTAKE GETTING THESE 2 MOTORS SWAPPED AS THEY ARE NEARLY IDENTICAL IN APPEARANCE. THE J1 MOTOR HAS THE EG10 NUMBER INDICATING A 10:1 GEAR RATIO

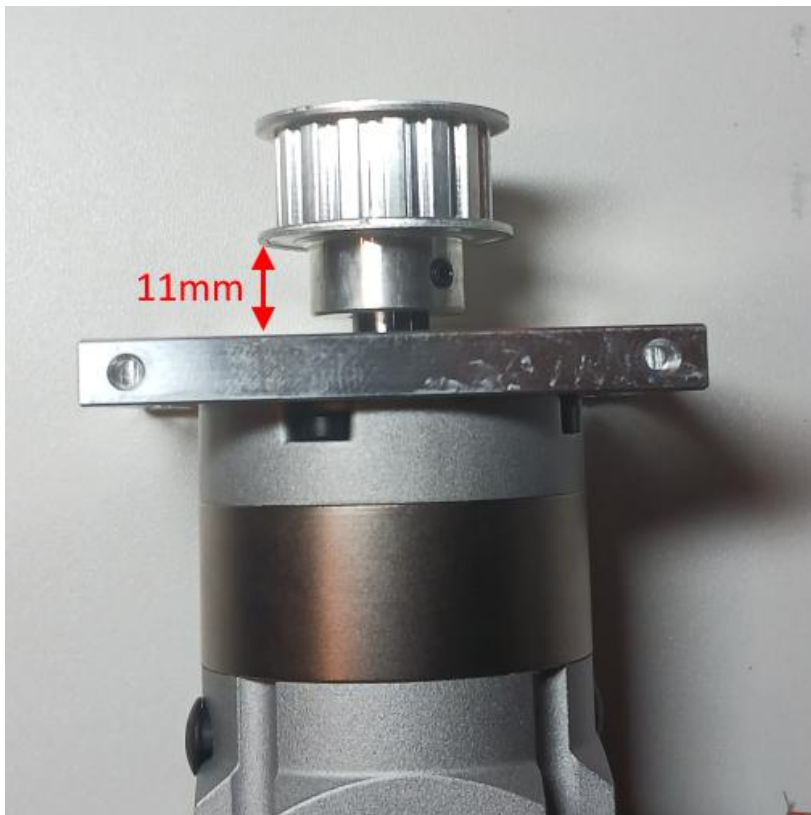

Install XL15 tooth 8mm bore drive sprocket on J1 gear motor shaft, make sure key is aligned in pulley slot and secure with (2) M3x4 set screws.

Make sure the lower flange of pulley is set at a distance of 11mm as indicated by the red arrow.



Install (2) M3x10 set screws in rear of motor mount slots.

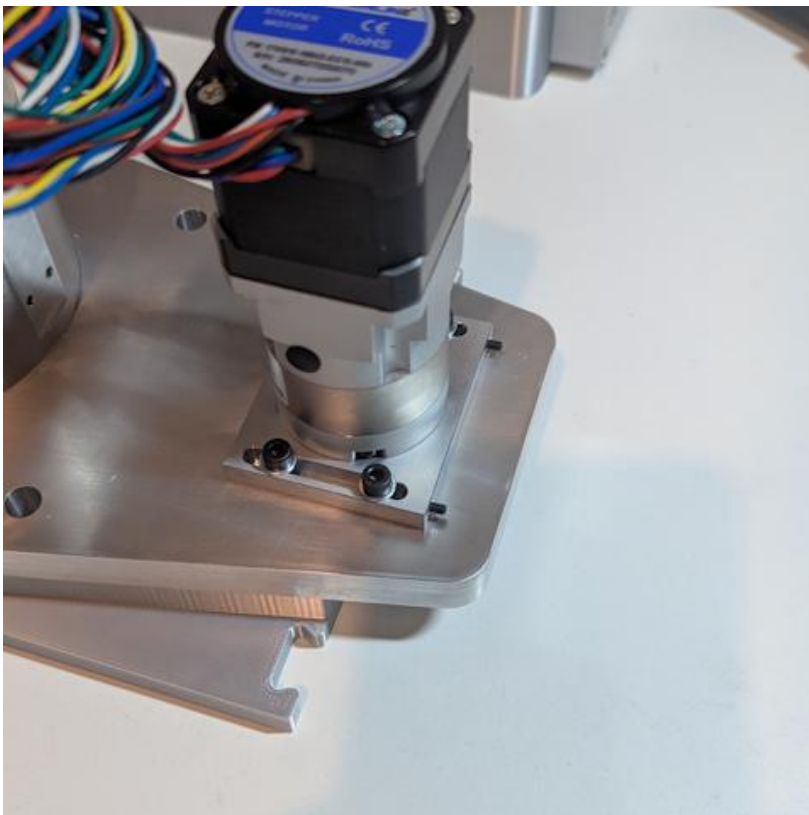

Install motor assembly onto base and

secure with (4) M4 X 20 socket head cap screws and (4) washers but do not fully tighten until after belt is tensioned.

NOTE: Make sure (2) 3mm tension holes located on ends of slots are facing toward back as shown in the photo.

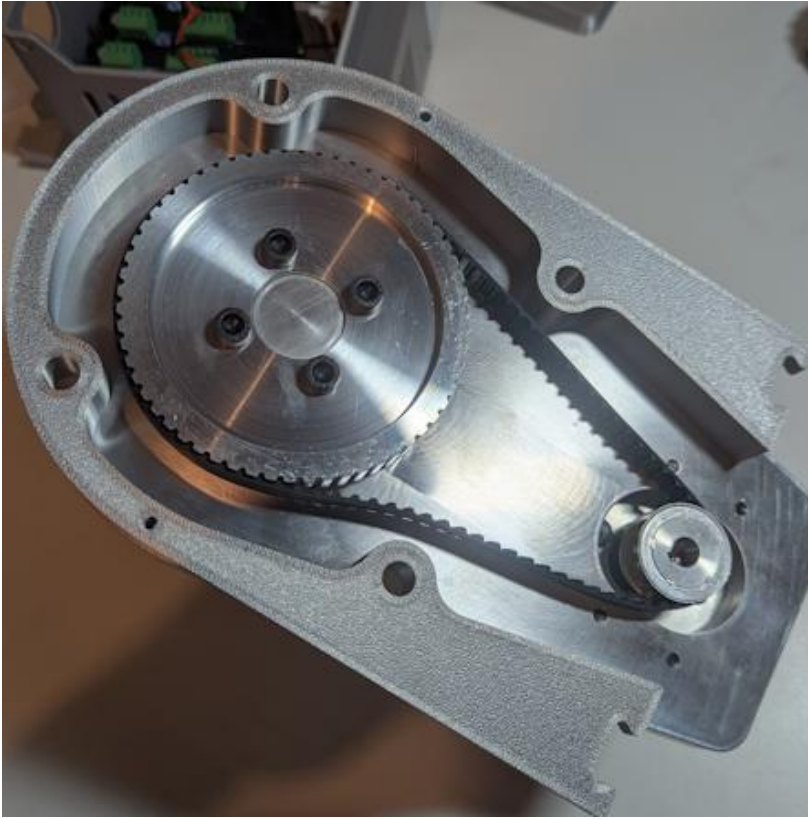

Install 60T timing hub pulley onto J1 spindle and secure with (4) M6x14 socket head cap screws, then install 180XL037 belt as shown.

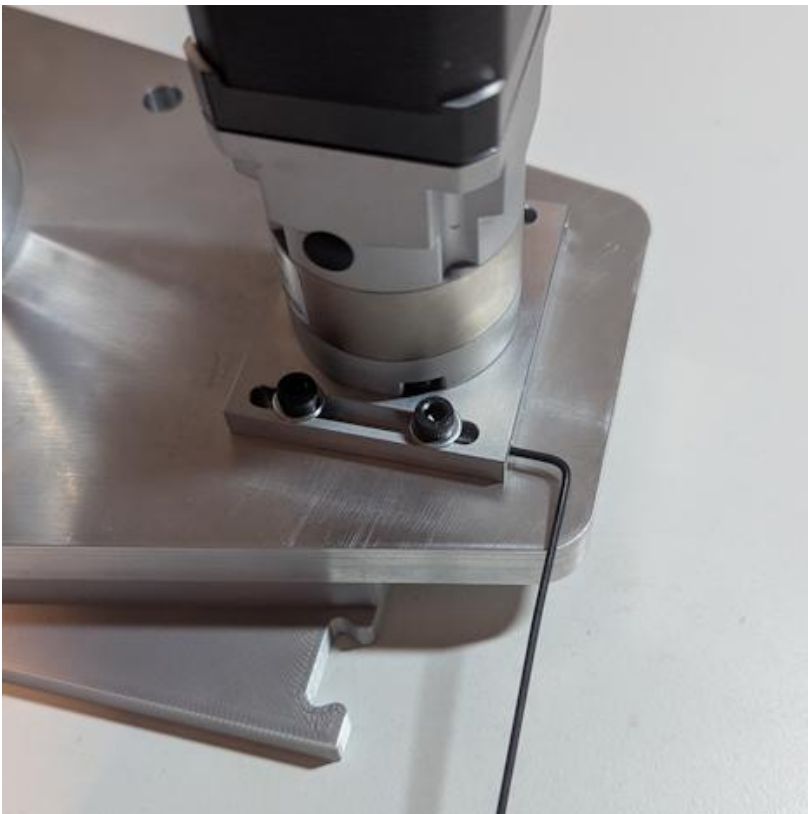

Make sure the (4) 4mm X 20 socket head cap screws securing the motor to the baseplate are slightly loose so that motor can slide to apply belt tension.

Tension J1 belt using (x2) M3x10 set screws in rear of motor mount slots.

Belt Tension: Tighten the LX belt until all slack is removed and there is no detectable backlash when reversing direction by hand. The belt should feel firm and taut—not loose or floppy. A slightly tighter belt is generally preferable to one with measurable play, but avoid excessive tension.

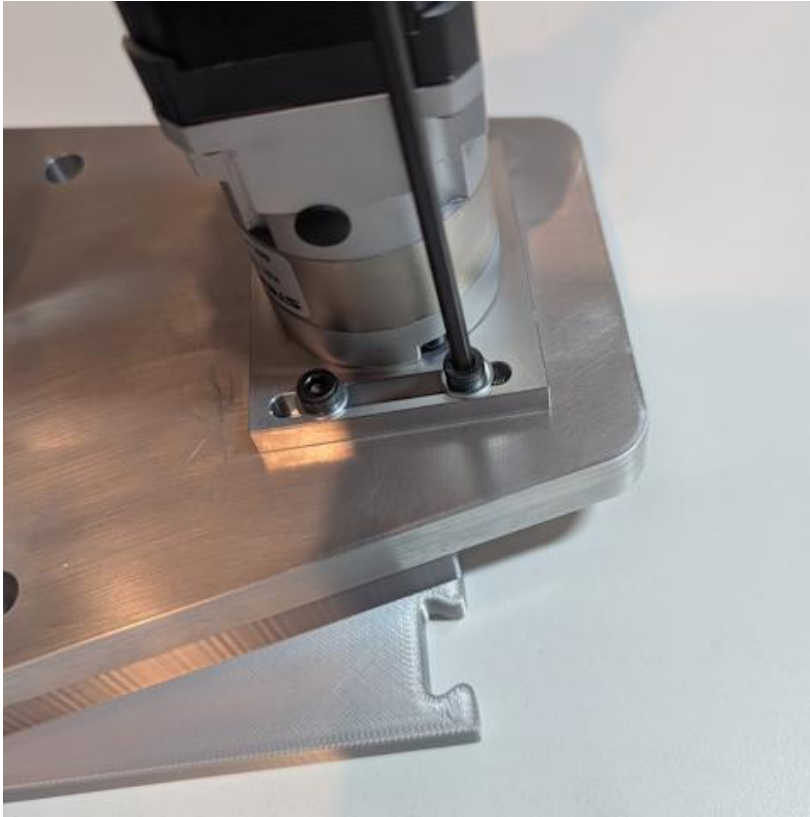

Once belt has moderate tension tighten the (4) 4mm X 20 socket head cap screws securing the motor to the baseplate.

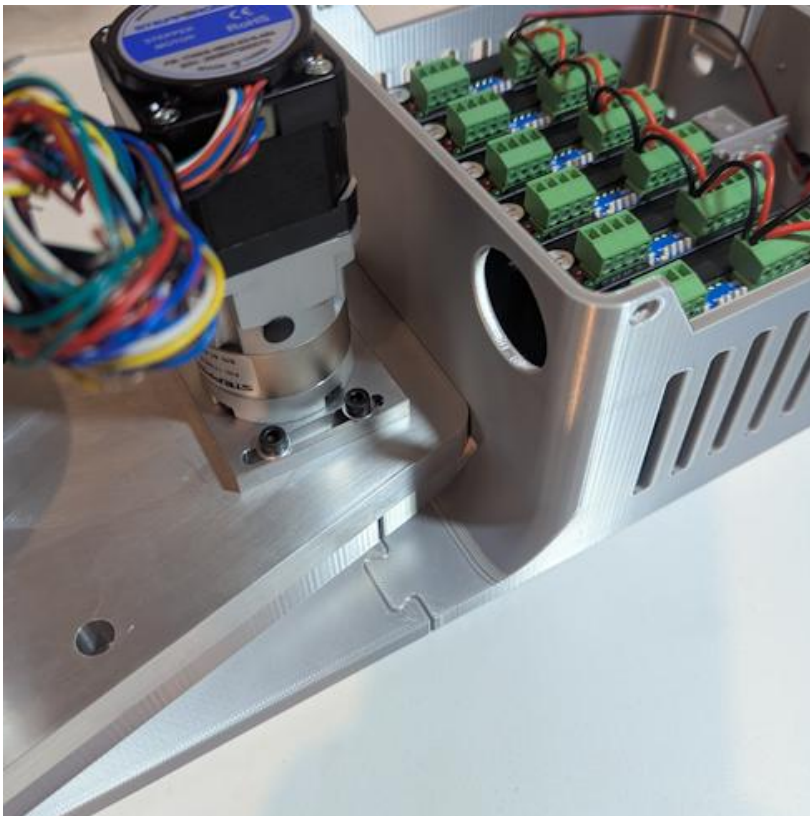

Install the J1 base assembly onto the enclosure assembly as shown so that the 3D printed base interlocks with the enclosure.

From this point forward the robot and enclosure should remain on a flat work surface. If the robot and enclosure need to be relocated to another location lift the robot and enclosure carefully so that both are supported.

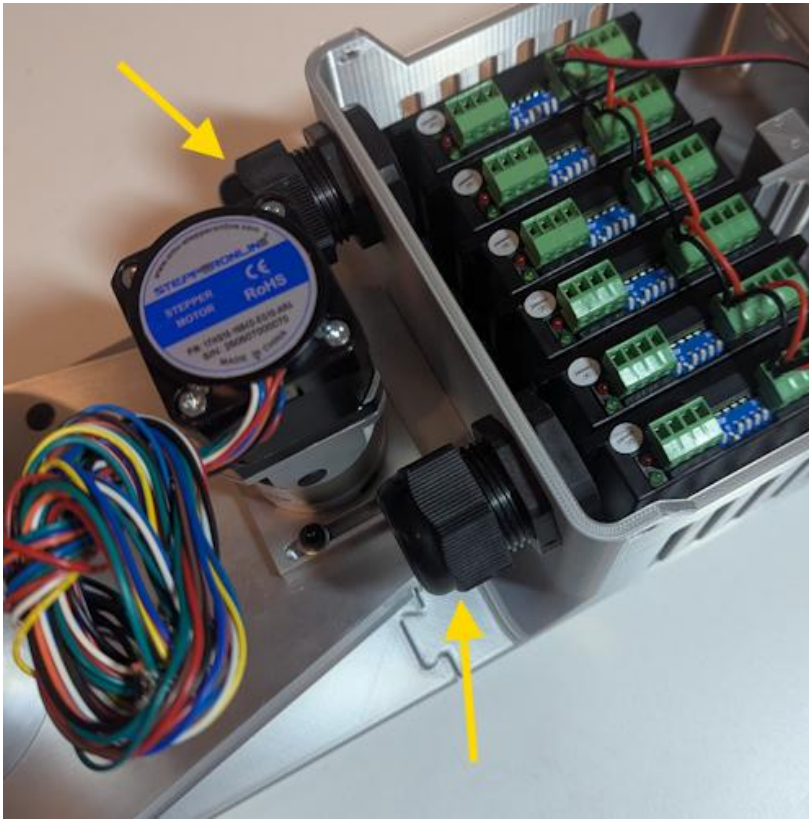

Install (2) PG-21 gland nuts into base enclosure as shown.

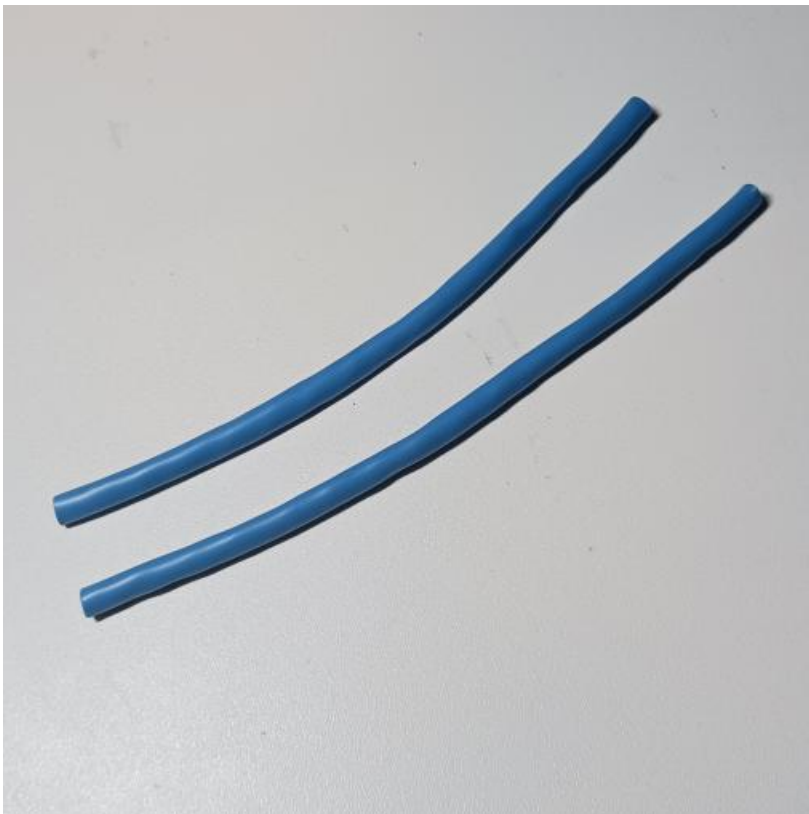

Cut (2) lengths of solid strand Cat5 cable to lengths of 145mm.

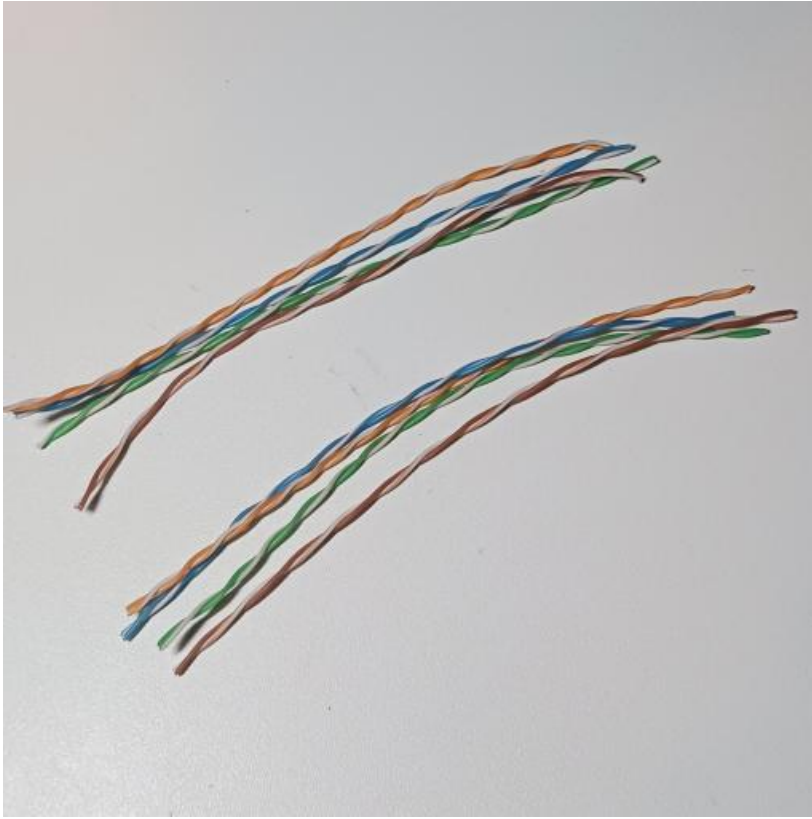

Remove outer sheathing from cable lengths.

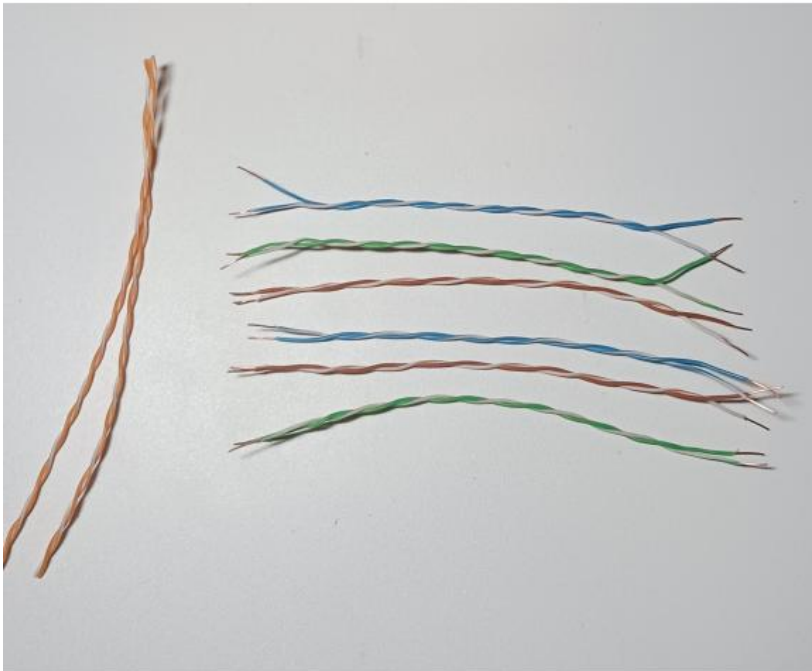

Set the orange pairs of wires aside and then strip the ends of the blue, green and brown pairs of wires.



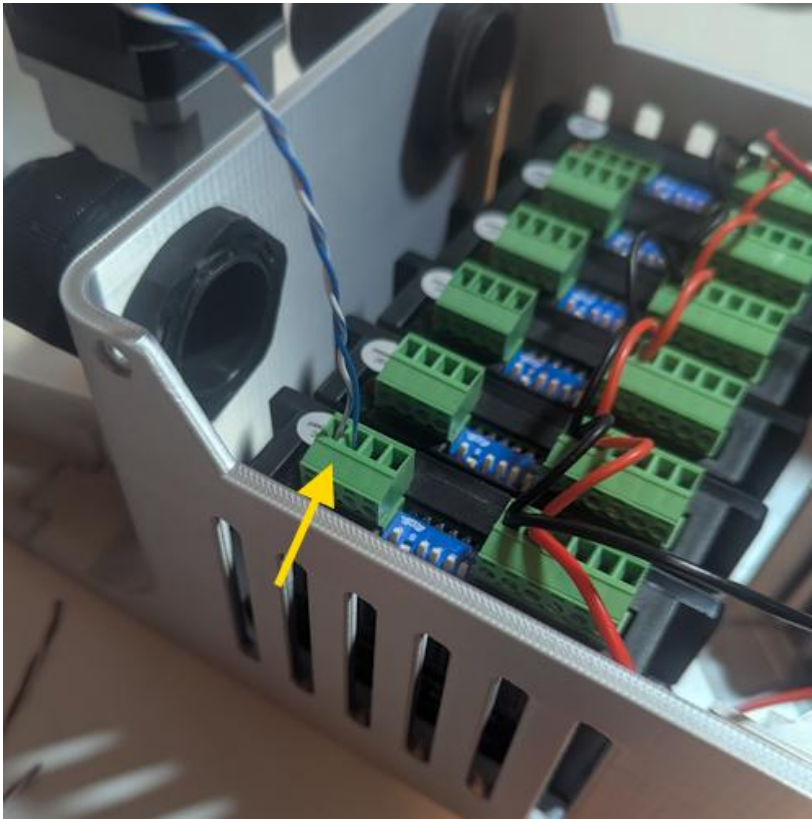

Insert one of the blue pairs of wire into the J1 driver on the far left.

The solid blue wires goes to the “PUL” terminal.

The striped wire goes to the “DIR” terminal.

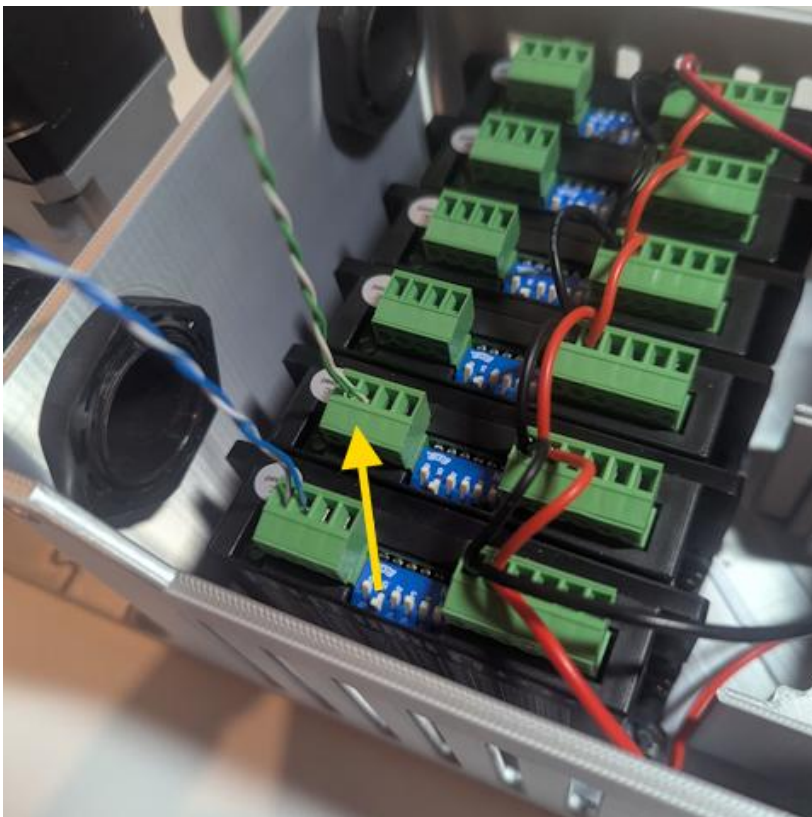
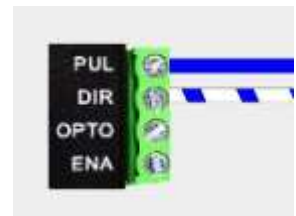

Insert one of the green pairs of wire into the J2 driver as shown.

The solid green wires goes to the “PUL” terminal.

The striped wire goes to the “DIR” terminal.



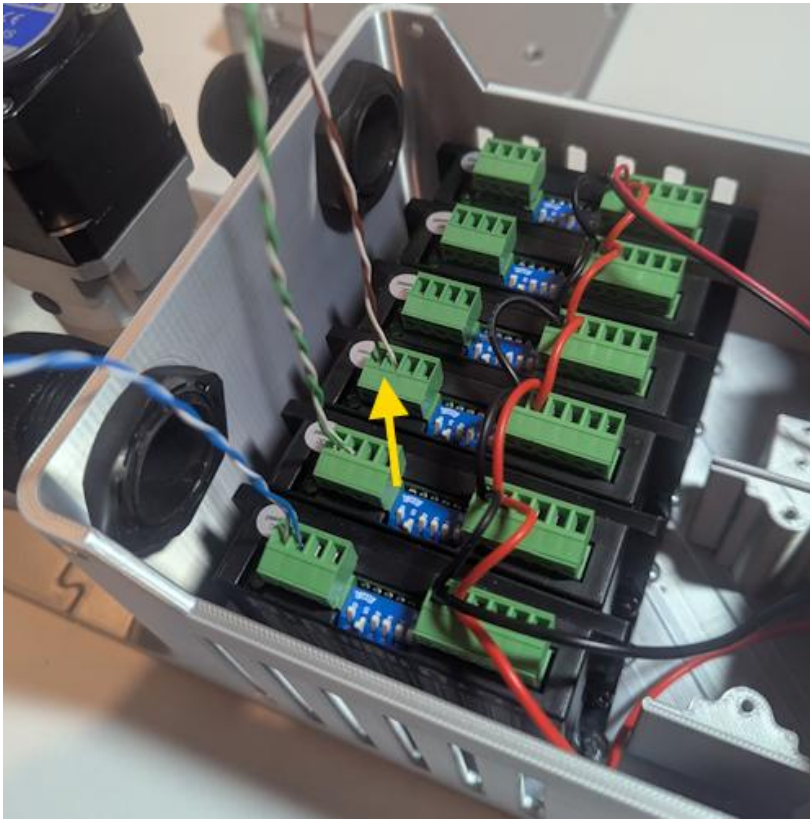

Insert one of the brown pairs of wires into the J3 driver as shown.

The solid brown wire goes to the “PUL” terminal.

The striped wire goes to the “DIR” terminal.

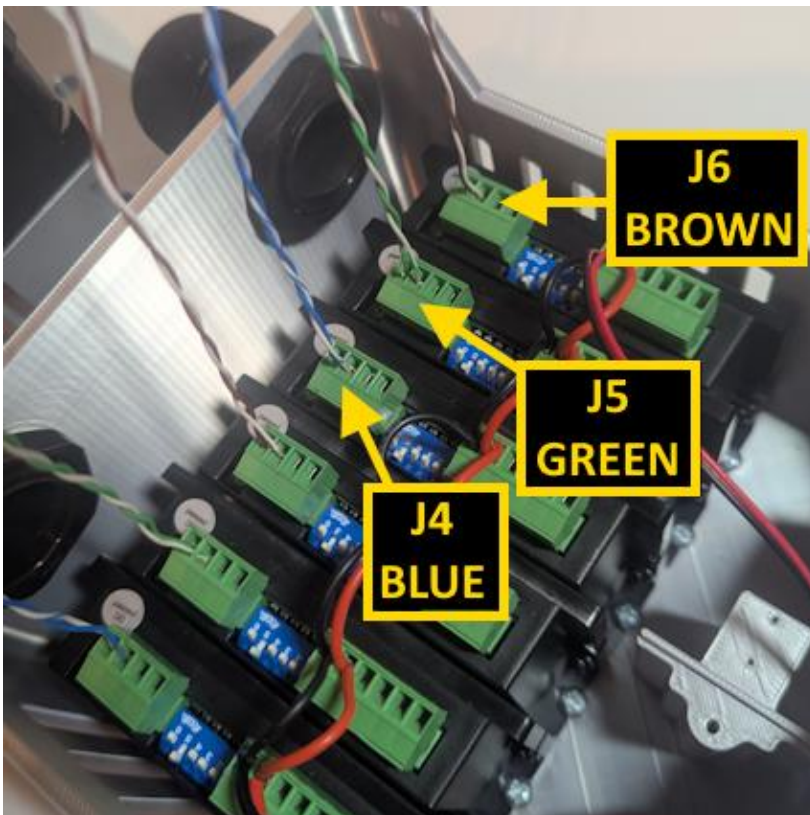
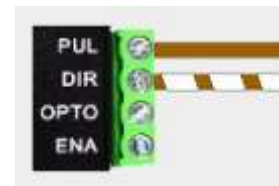

Repeat the previous (3) steps and install a blue pair of wires into the **J4** driver, a green pair of wires into the **J5** driver and a brown pair of wires into the **J6** driver.

The solid color wire should go to the “PUL” terminal and the striped wire should go to the “DIR” terminal.



With the remaining lengths of orange pair wires – separate the solid color from the stripe color wires.

Cut the solid orange wires into lengths of 43mm and strip the ends of (5) of them.

Do not cut the stripe wires.

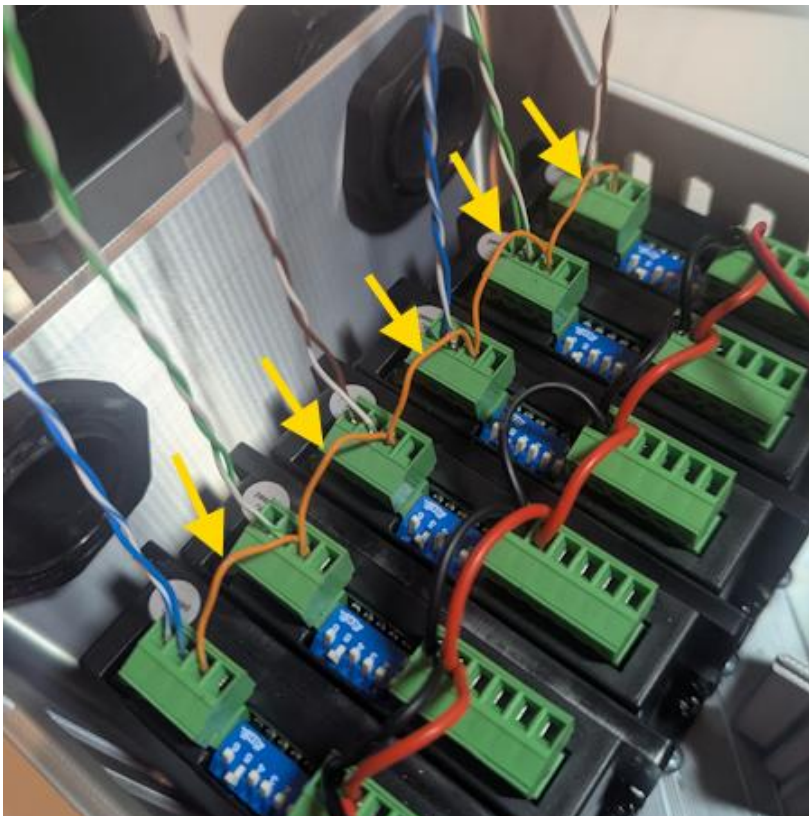

Install the (5) lengths of solid color orange wire from the “OPTO” terminal from one driver to the next.

The “OPTO” terminal should be jumpered across all 6 drivers as shown.

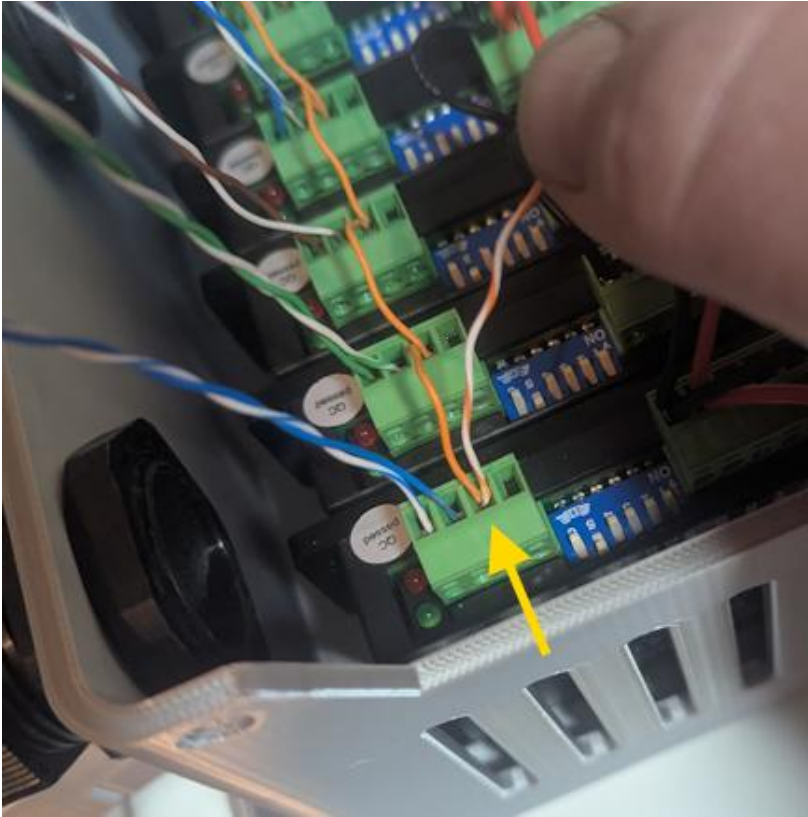

Install (1) of the remaining 130mm long orange stripe wires to the "OPTO" terminal on the far left J1 driver as shown.

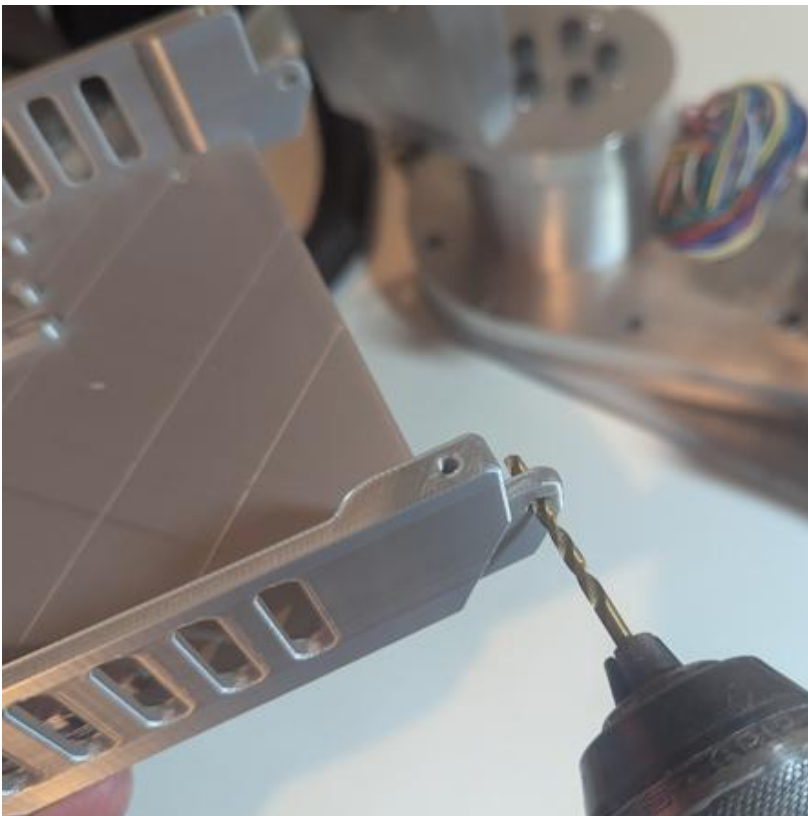

Carefully remove all build structure from the J1 BASE ENCLOSURE TRAY. Use 3mm drill to clear or clean out the (2) hinge holes on each side as shown.

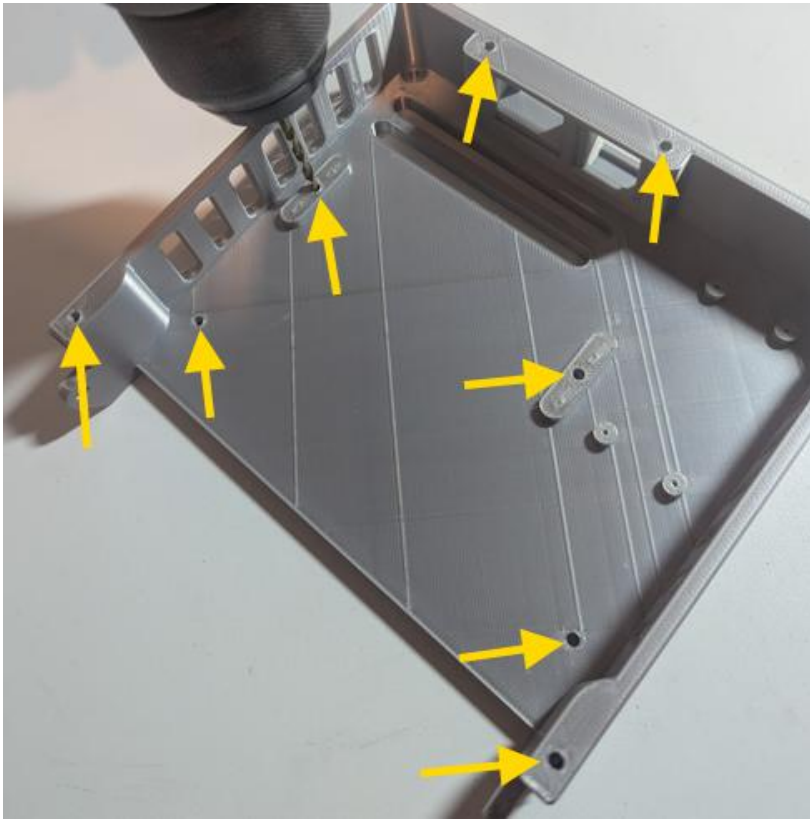

Use 3mm drill to clear or clean out the (8) screw mounting holes indicated in the J1 BASE ENCLOSURE TRAY.

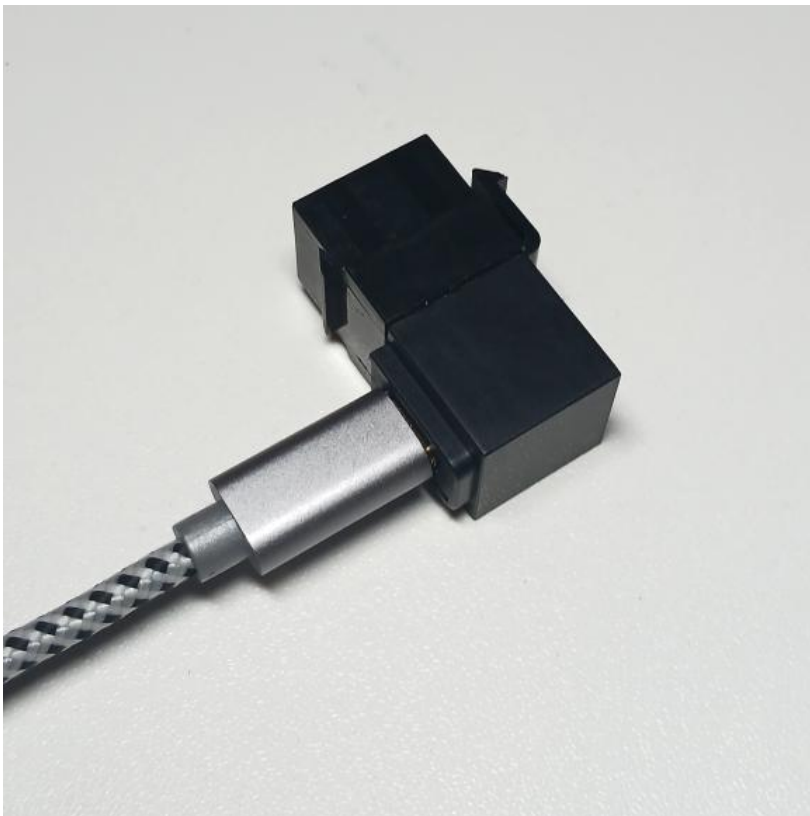

Insert the USB-C end of the USB extension cable into the USB-C 90° Keystone Jack as shown in photo.

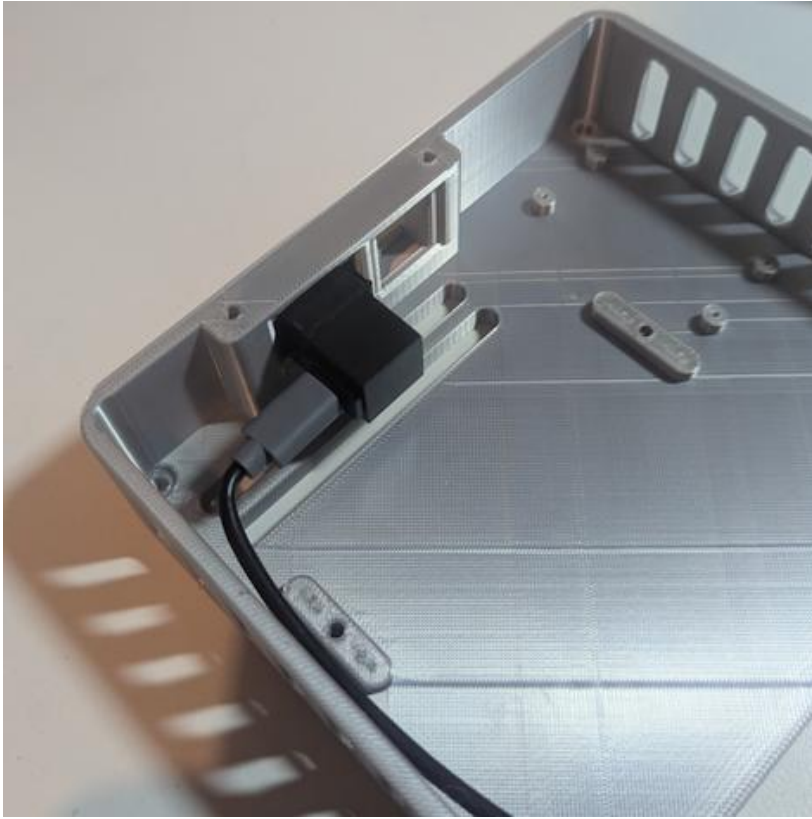

Install USB-C 90° Keystone Jack into left socket of J1 enclosure tray as shown in photo.

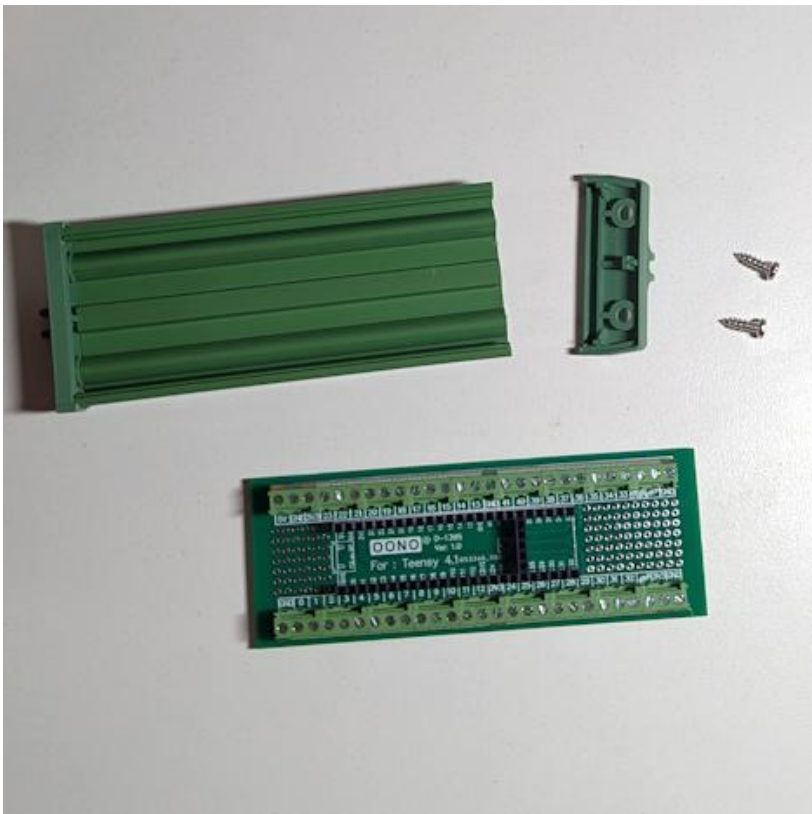

Remove (2) side screws from teensy4.1 breakout board enclosure, remove side cover and slide board out of enclosure as shown.



Cut length of (6) PCB header pins from strip of pins supplied with terminal breakout board.

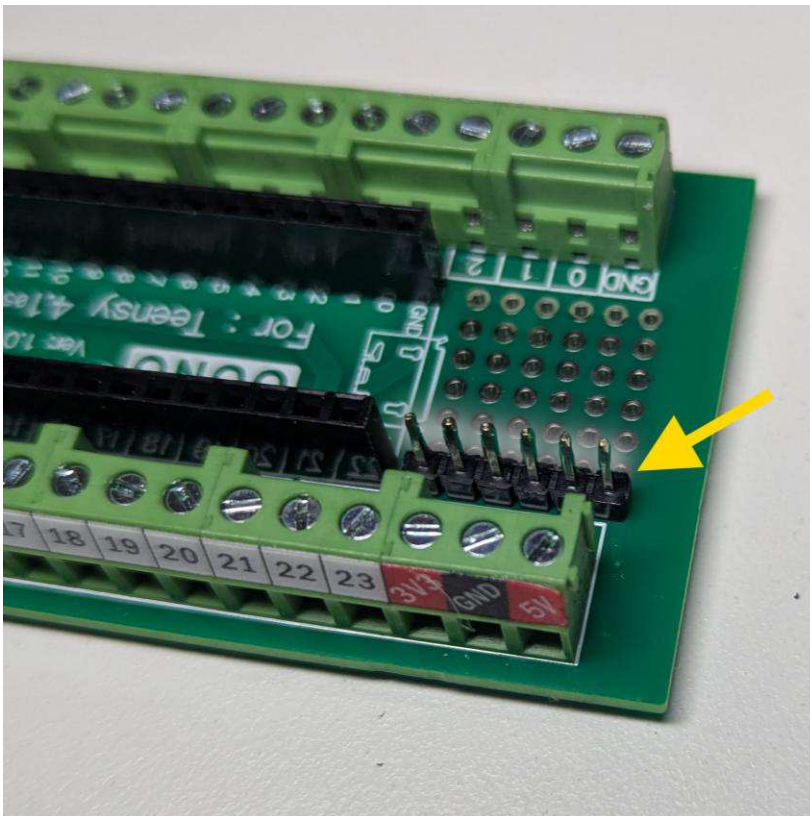

Install row of (6) header pins in first row of teensy perfboard right next to the 5V and GND terminals as shown in photo.

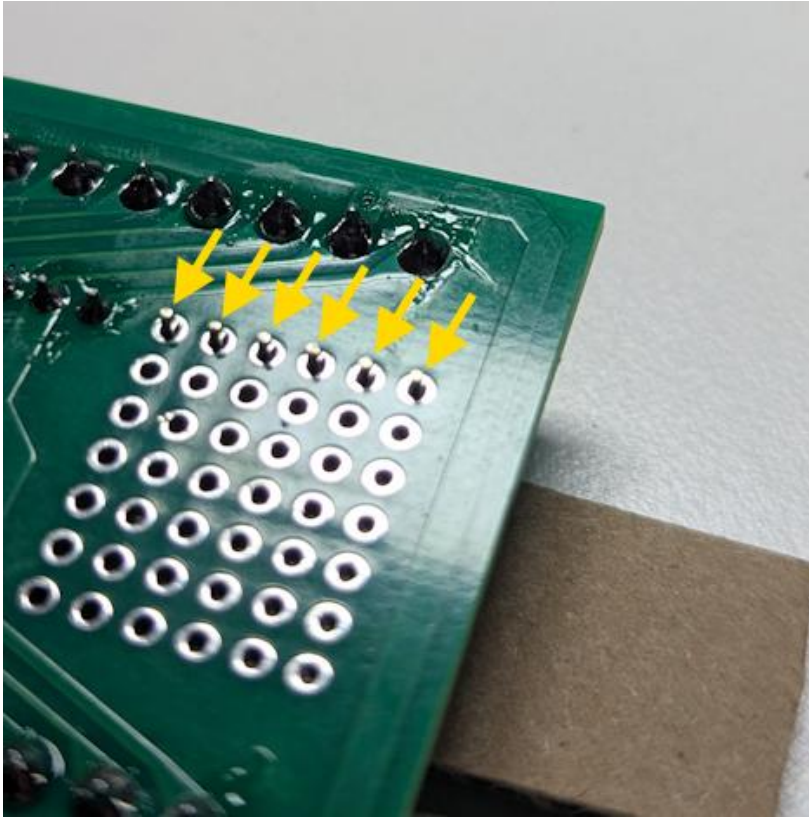

Hold header pins in place and carefully flip board over. Place a small piece of cardboard under the header pins to hold them up so that the short side of pins is fully extended through perfbboard.

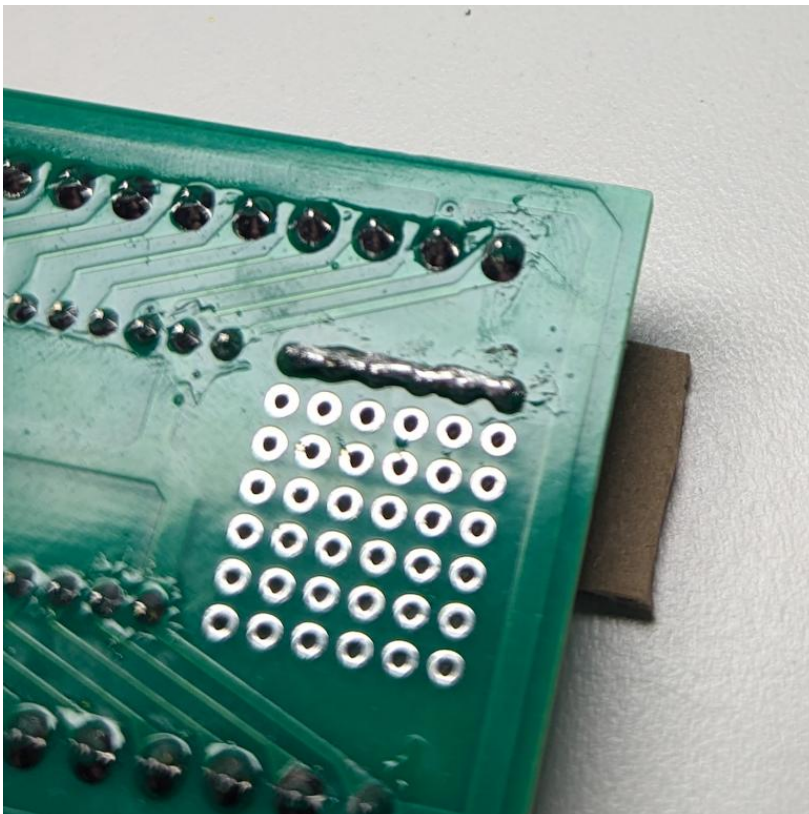

Use soldering iron and electrical solder to bridge solder across all 6 pin terminals.

This is known as “**solder-bridging**” or “**solder-bussing**”

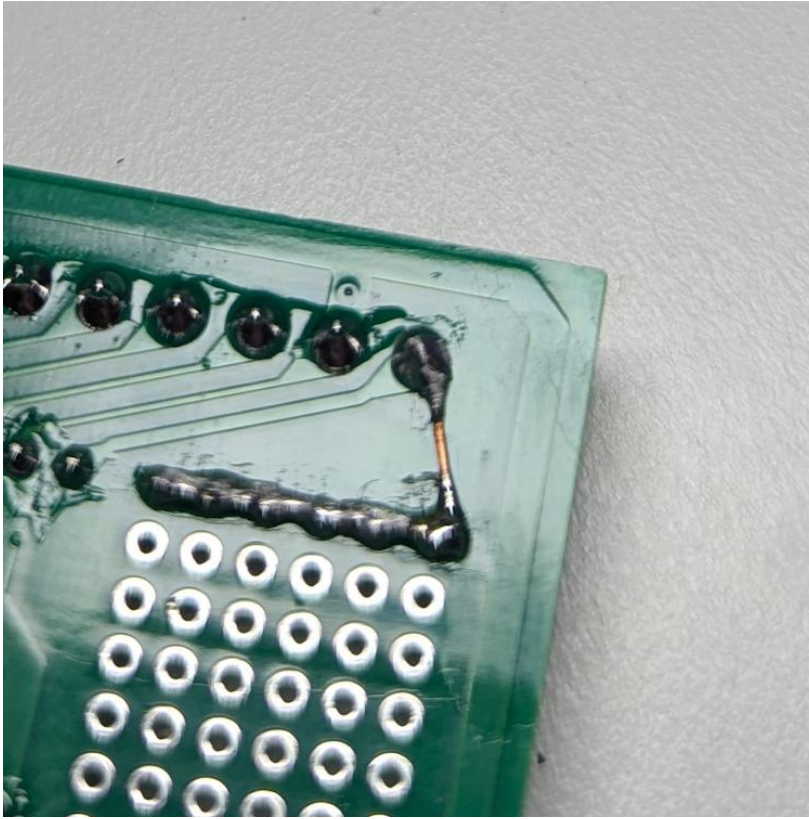

Cut an 8mm long length of copper wire from one strand of CAT5 cable. Remove wire jacket – *I have found it easiest to use a lighter or flame to soften the insulation jacket and then carefully remove or pull off insulation in pieces.*

Solder wire from the 5V terminal over to the solder bridge as shown.

MAKE ABSOLUTELY SURE YOU DO NOT BRIDGE SOLDER ACROSS TO THE GND TERMINAL – USE A MULTIMETER ACROSS THE GND AND 5V SCREW TERMINALS TO VERIFY THEY ARE NOT SHORTED !!

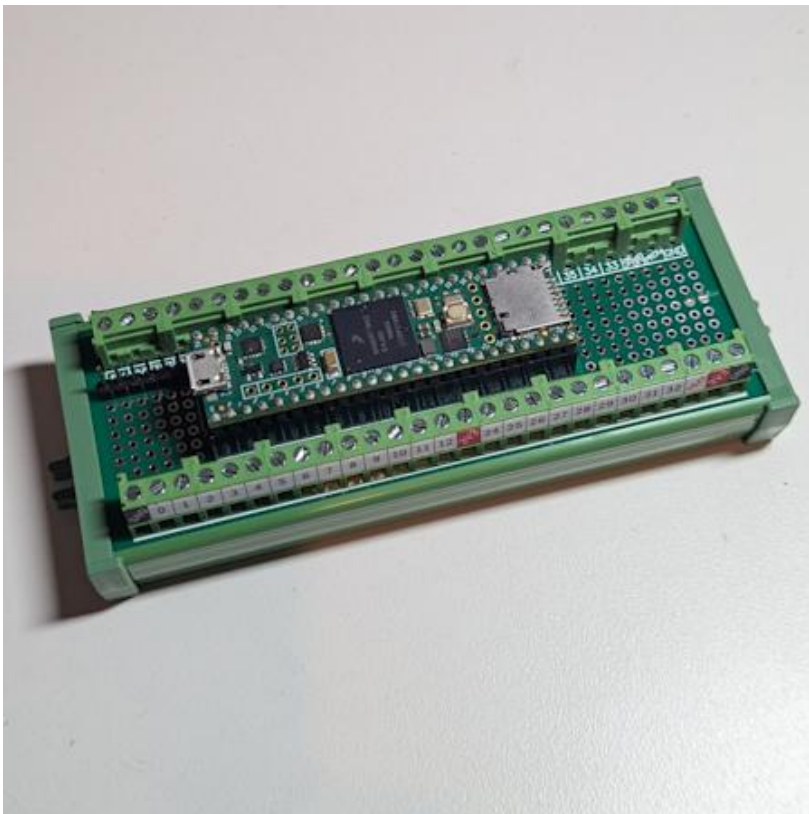

Reinstall breakout board into enclosure, install side cap and screws.

Install the Teensy4.1 board into its socket as shown.

Make sure the Teensy4.1 USB port is oriented to the left as shown in the photo – toward the same side as the 5v terminal.

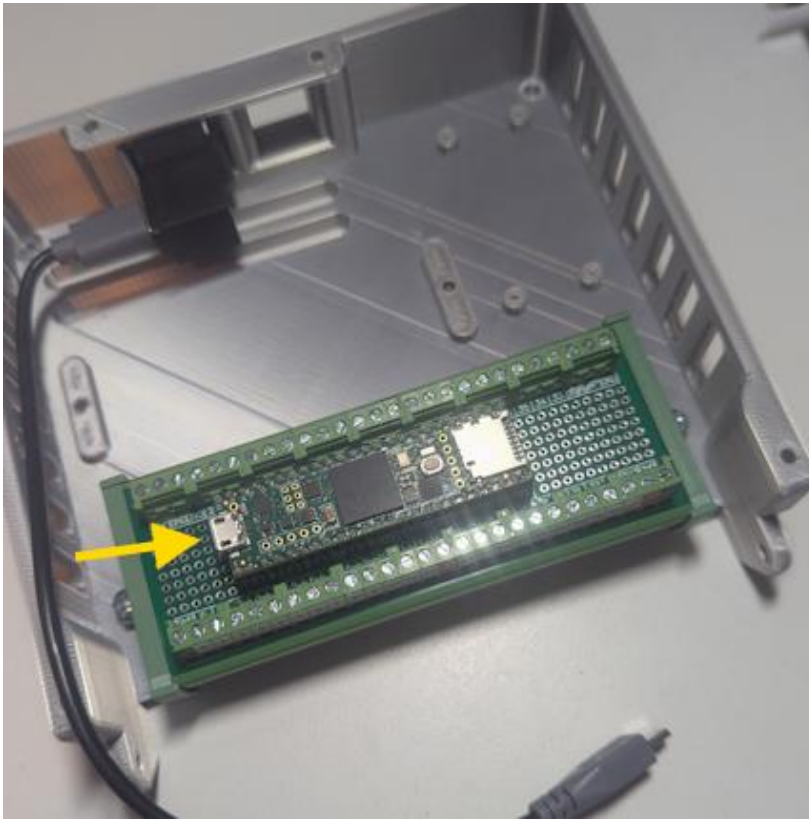

Install Teensy 4.1 and breakout board into J1 enclosure tray as shown and secure with (2) #6 thread form screws.

NOTE: the USB connector should be oriented to the left side as shown in photo (yellow arrow).

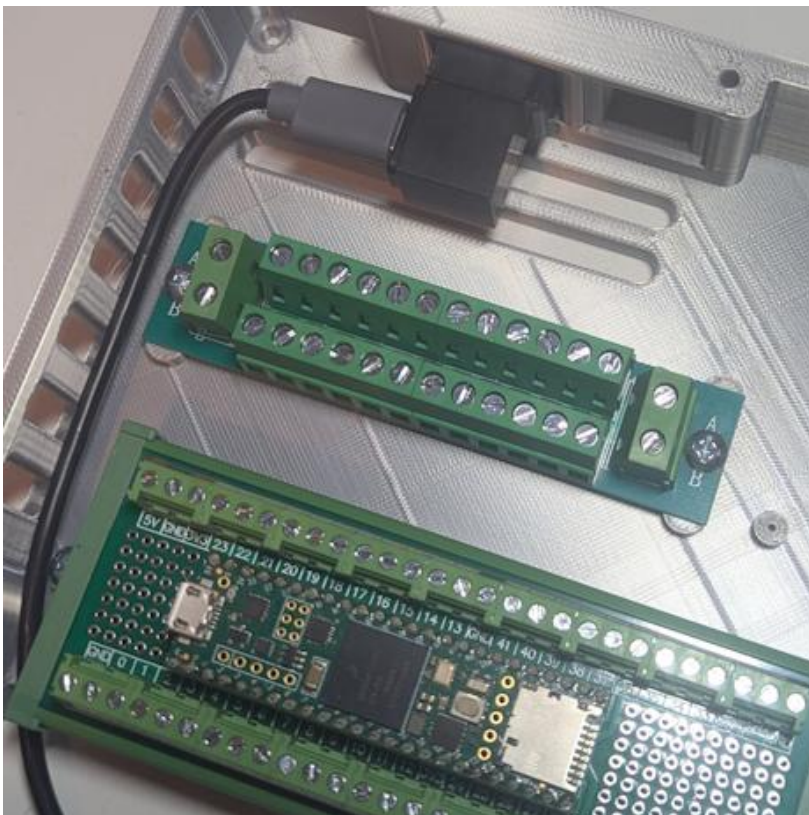

Install 2x12 terminal board as shown and secure with (2) #6 thread form screws.

NOTE: install board with “A” and “B” labels up shown in photo.

*It's also important to note that from an electrical termination standpoint the “A” and “B” terminals **alternate** across the top and bottom terminal rows – the top are **not** all connected to “A” and the bottom are **not** all connected to “B”.*

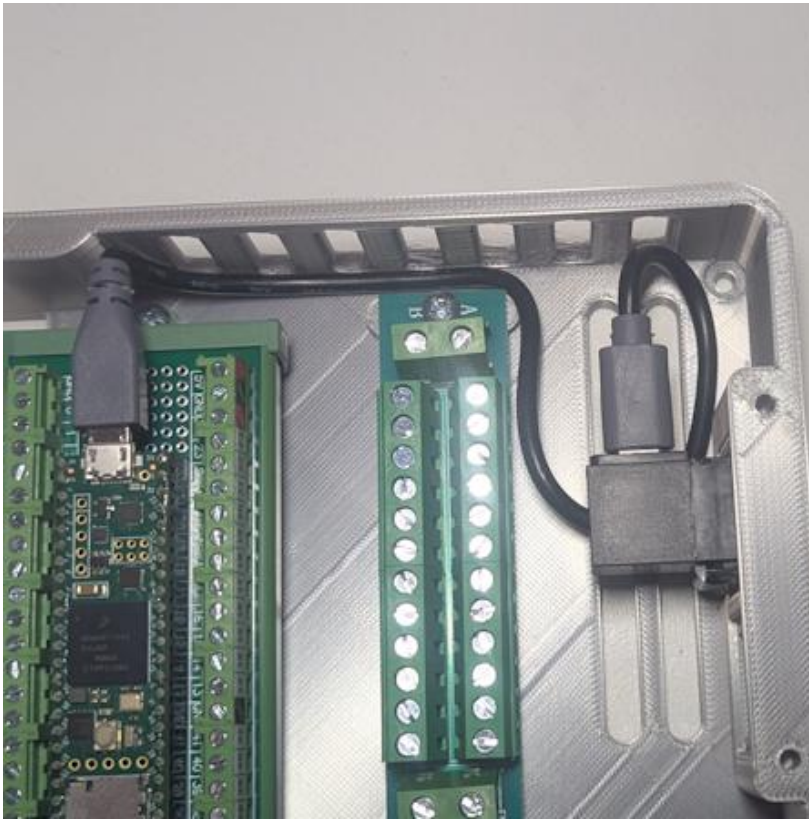

Plug Micro USB end of cable into Teensy 4.1 board and route as shown.

NOTE: you may need to unplug or lift teensy board from its socket when plugging in the USB cable.

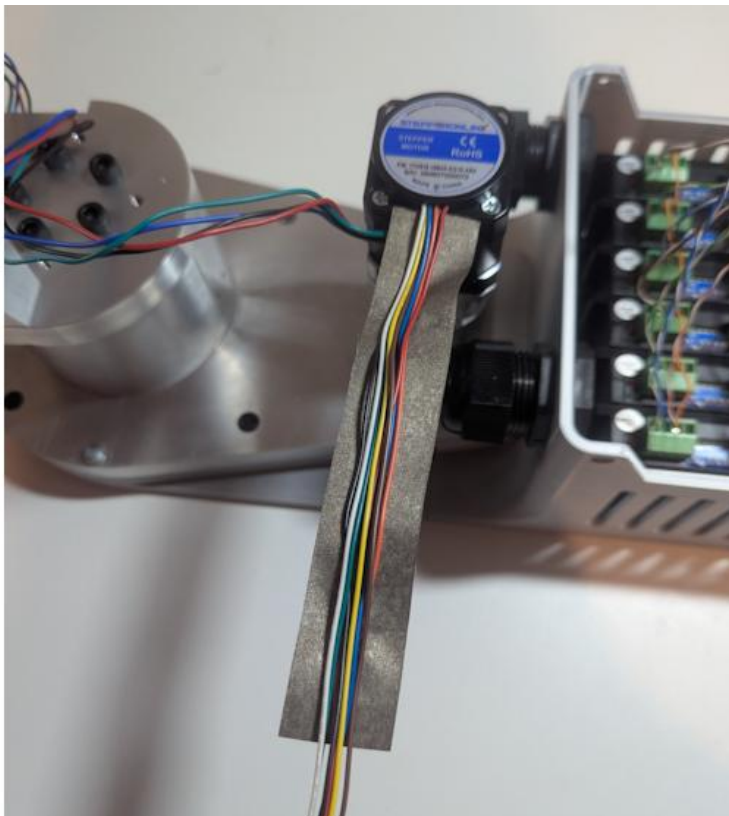

Remove adhesive back from 14cm length of EMI shielding tape and apply to the J1 encoder wires as shown.

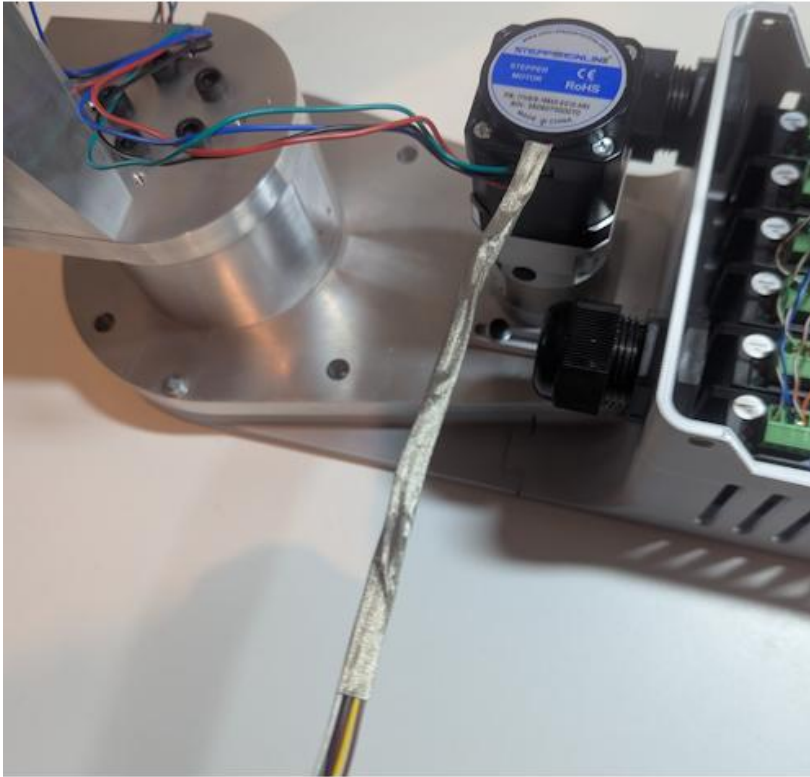

Wrap adhesive around encoder wires as shown.

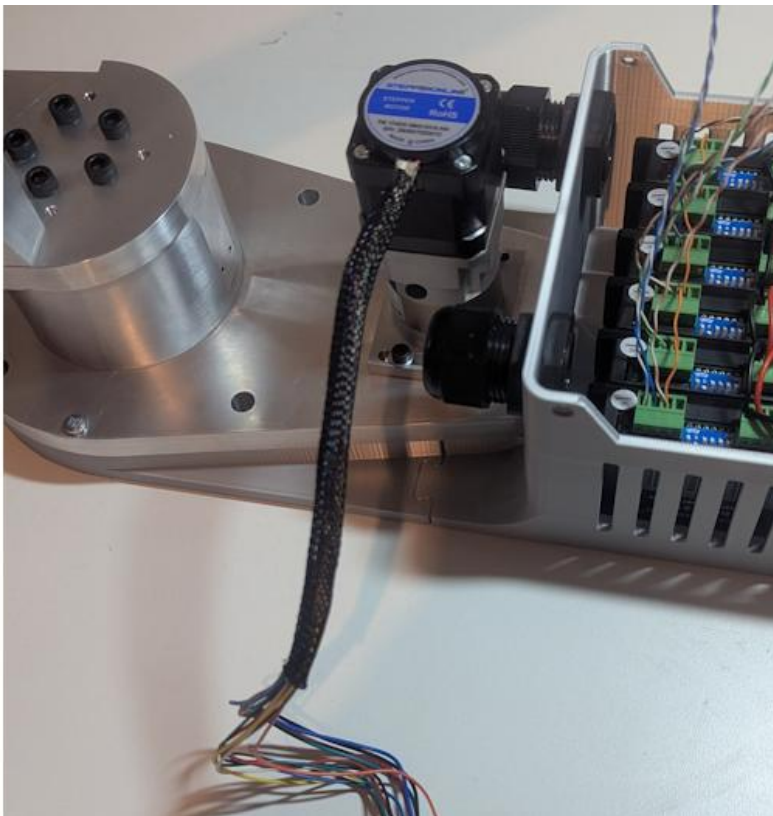

Cut length of $\frac{1}{4}$ " braided sleeve to a length of 16.5cm long then route the J1 motor and encoder wires through the sleeve as shown.

It is recommended to use a lighter to slightly singe the ends of the braided sleeve to prevent the braided sleeve from fraying and becoming unbraided.



Route the J1 wires with braided sleeve into the J1 enclosure as shown.

NOTE: if desired you can apply liquid electrical tape to the base of the wires and braided sleeve. (yellow arrow)

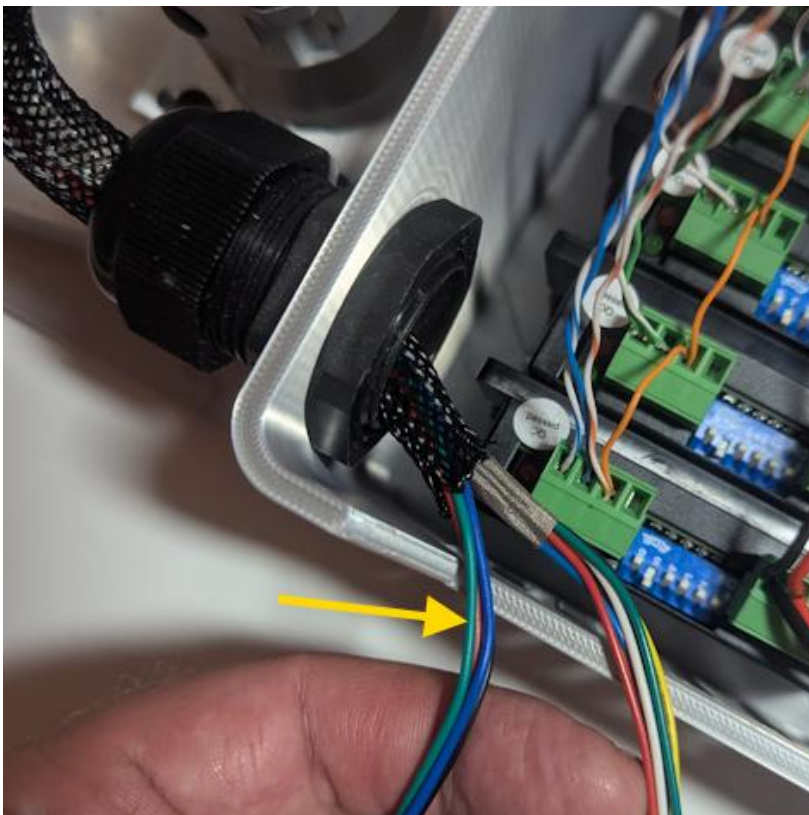

Identify and separate the Red, Black, Blue and Green motor power wires from the encoder wires.

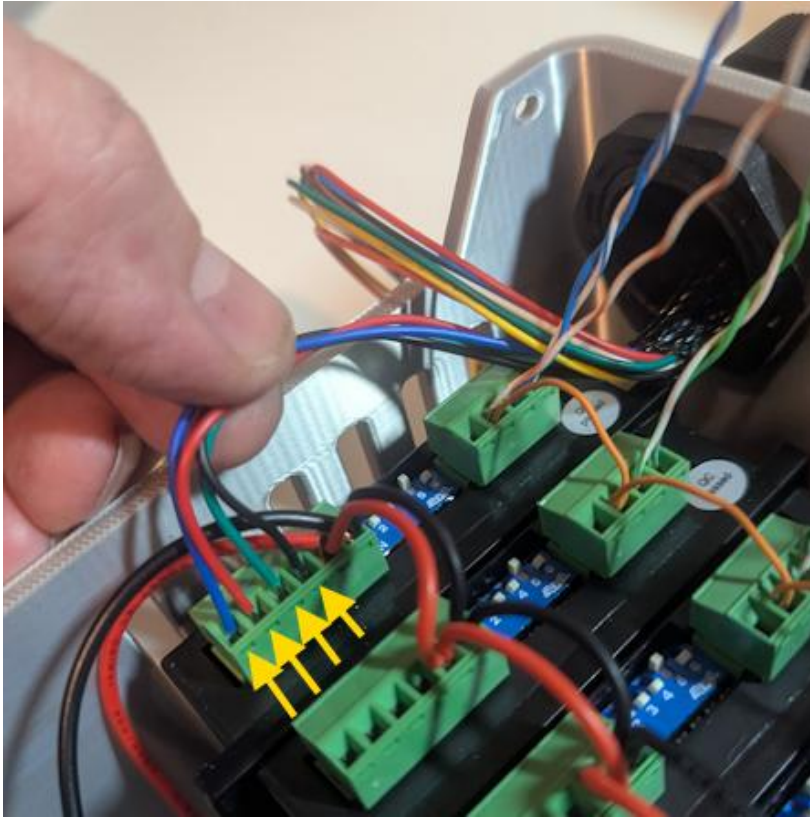

Trim motor wires to length as shown, then connect the (4) J1 motor wires to the J1 driver terminals as follows:

A+ BLACK

A- GREEN

B+ RED

B- BLUE

NOTE: save the remaining wire ends for future step.

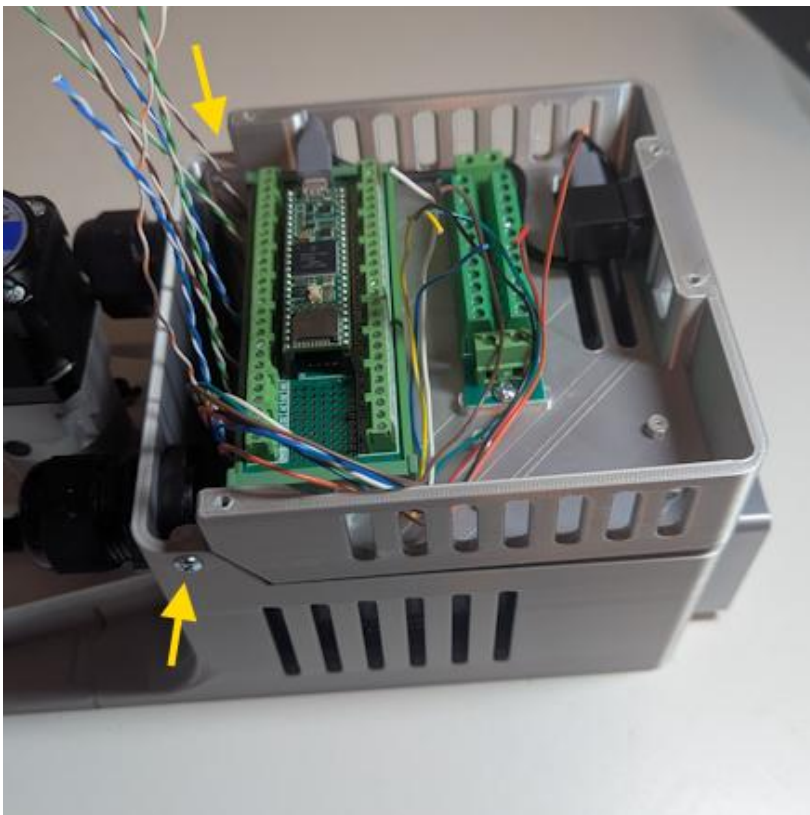

Install the J1 enclosure try onto the main base enclosure as shown.

Secure tray to base using (2) #6 thread form screws installed at the hinge locations on both sides (yellow arrow).

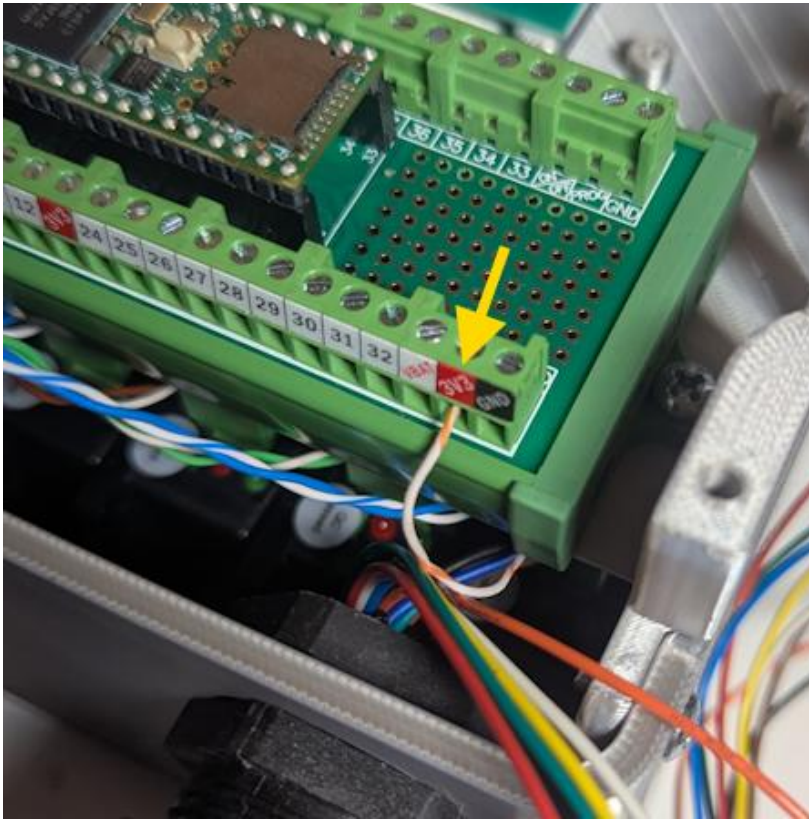

Trim orange stripe wire coming from the J1 driver OPTO terminal to length, strip wire end and connect the to the left 3.3V terminal as shown. (yellow arrow).

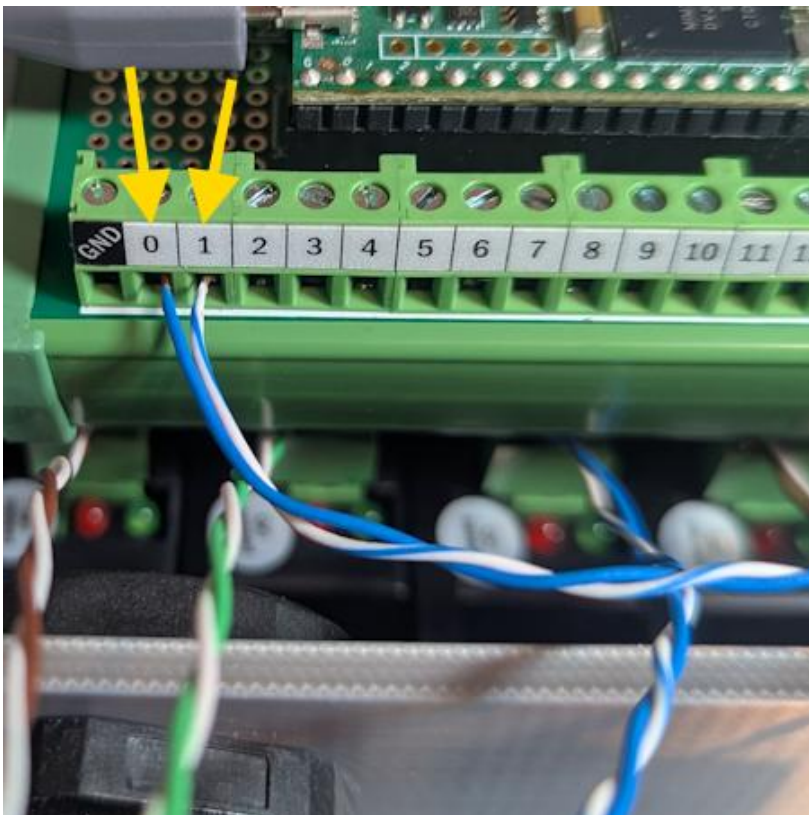

Trim the blue wires coming from the J1 driver to length. Then strip ends and – connect to the teensy breakout board as follows:

J1 driver “PUL” (solid blue) connect to terminal “0”

J1 driver “DIR” (blue stripe) connect to terminal “1”

NOTE: Also see wiring schematics section of manual.

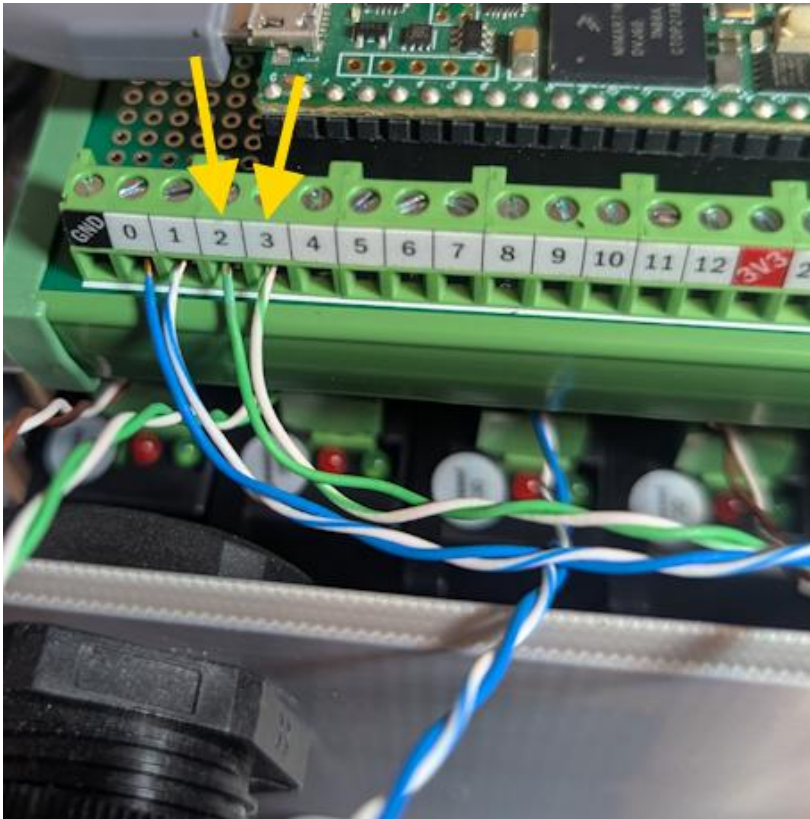

Connect the green wires coming from the J2 driver to the teensy board as follows:

J2 driver “PUL” (solid green) connect to terminal “2”

J2 driver “DIR” (green stripe) connect to terminal “3”

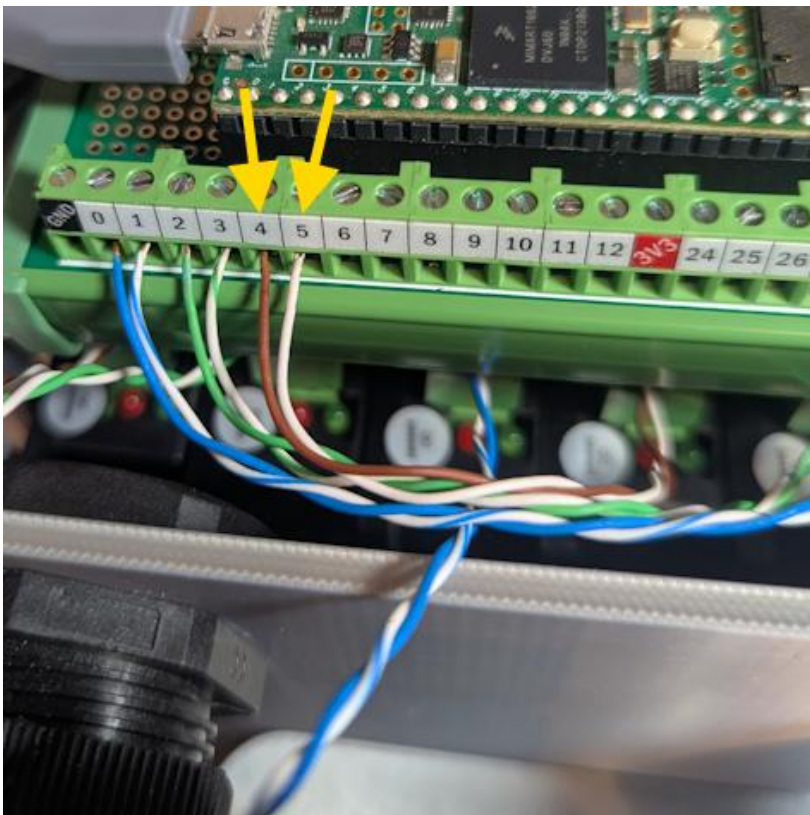

Connect the brown wires coming from the J3 driver to the teensy board as follows:

J3 driver “PUL” (solid brown) connect to terminal “4”

J3 driver “DIR” (brown stripe) connect to terminal “5”

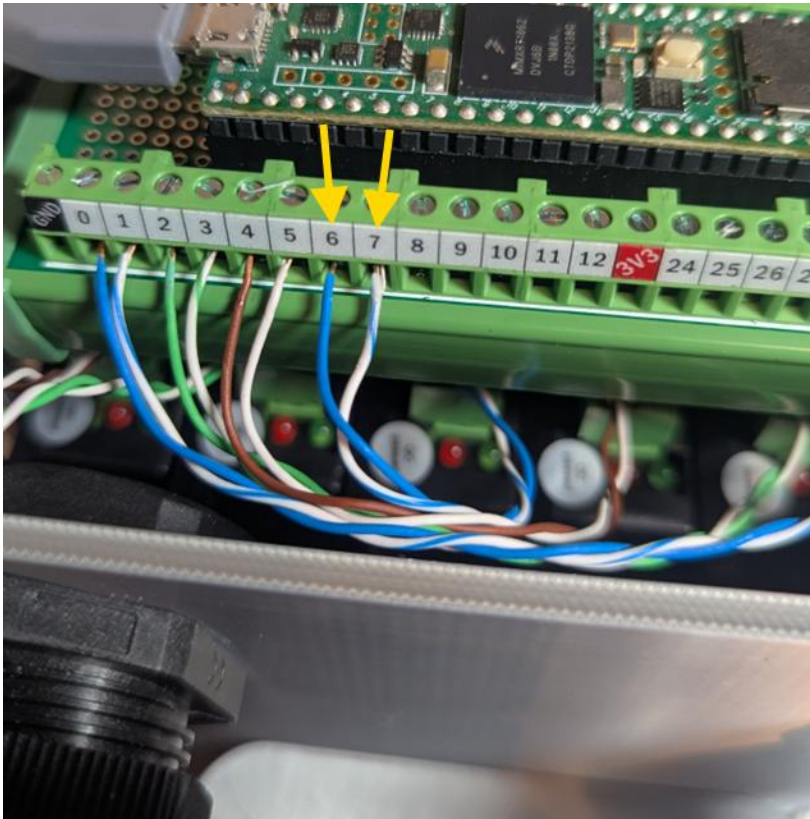

Connect the blue wires coming from the J4 driver to the teensy board as follows:

J4 driver "PUL" (solid blue) connect to terminal "6"

J4 driver "DIR" (blue stripe) connect to terminal "7"

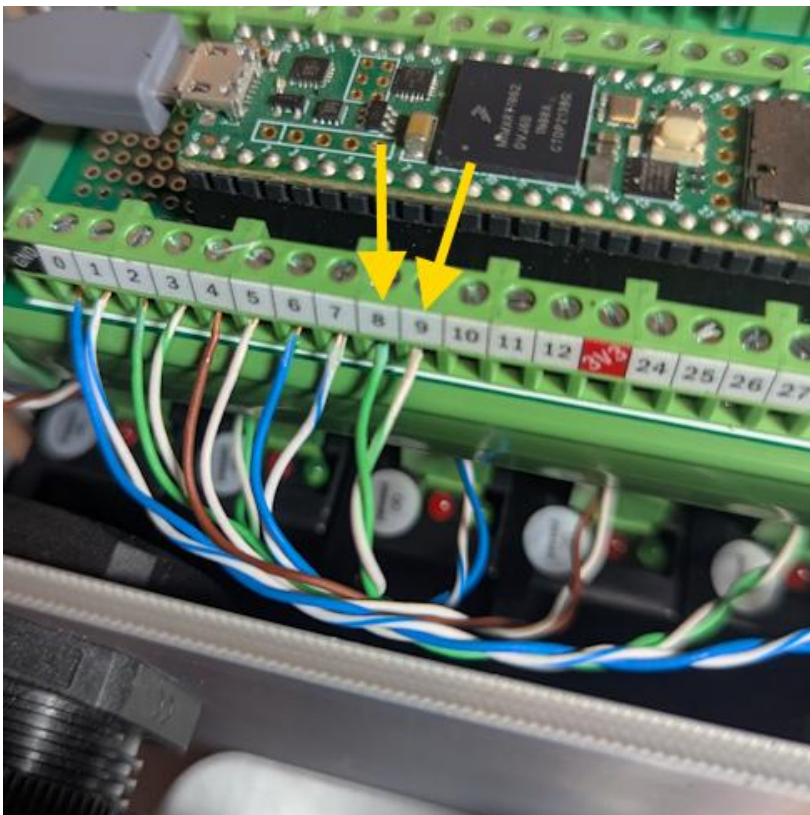

Connect the green wires coming from the J5 driver to the teensy board as follows:

J5 driver "PUL" (solid green) connect to terminal "8"

J5 driver "DIR" (green stripe) connect to terminal "9"

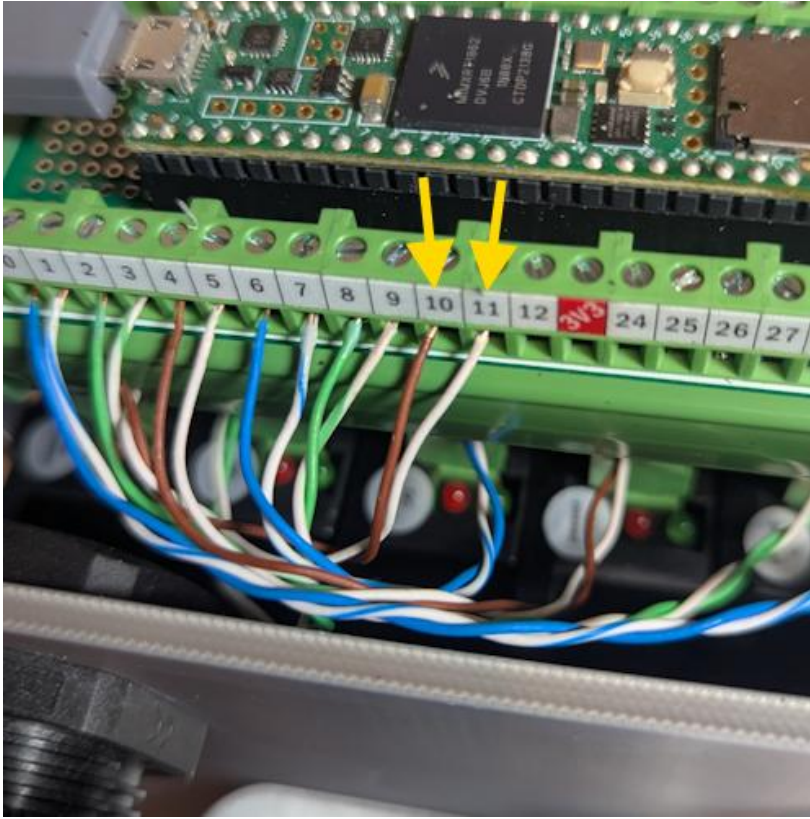

Connect the brown wires coming from the J6 driver to the teensy board as follows:

J6 driver “PUL” (solid brown) connect to terminal “10”

J6 driver “DIR” (brown stripe) connect to terminal “11”

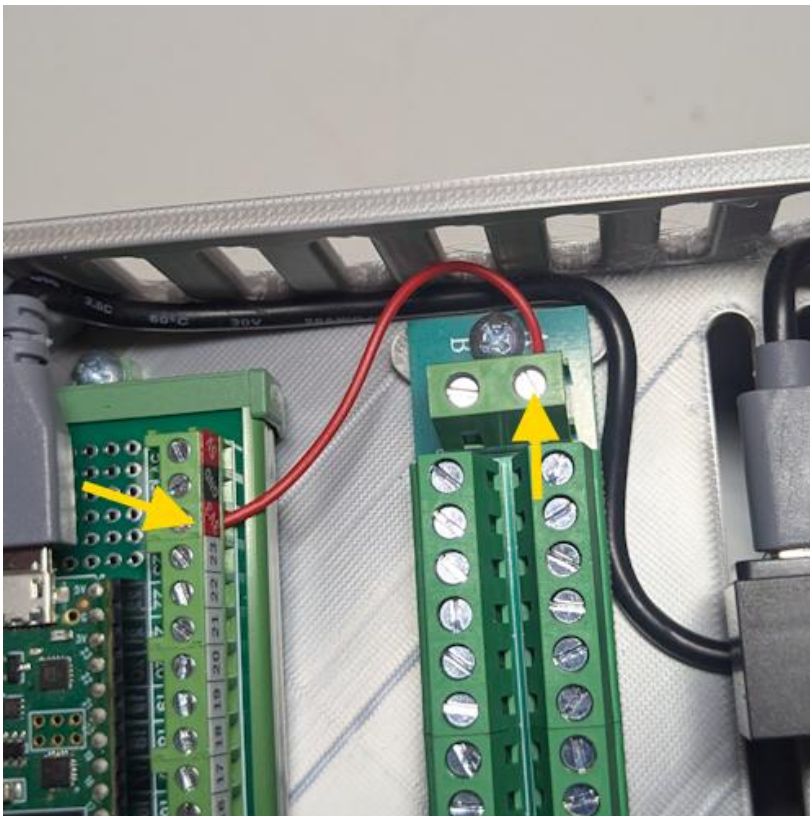

Use remainder motor wires, cut length of red wire, strip ends and connect wire from Teensy4.1 3.3v terminal to the 2x12 terminal board “A” terminal as shown.

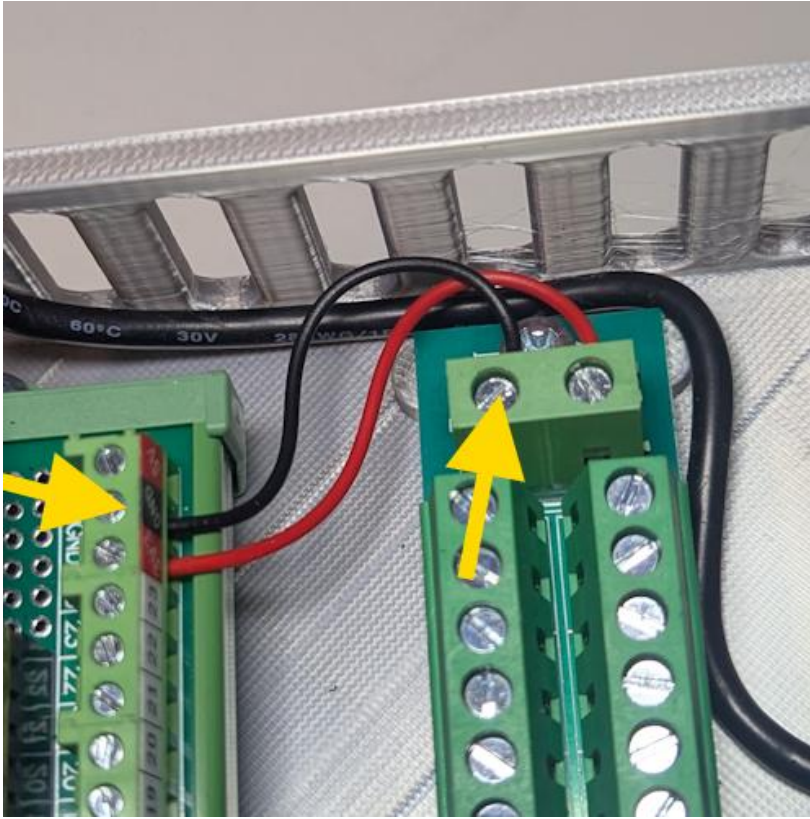

Use remainder motor wires, cut length of black wire, strip ends and connect wire from Teensy4.1 GND terminal to the 2x12 terminal board "B" terminal as shown.

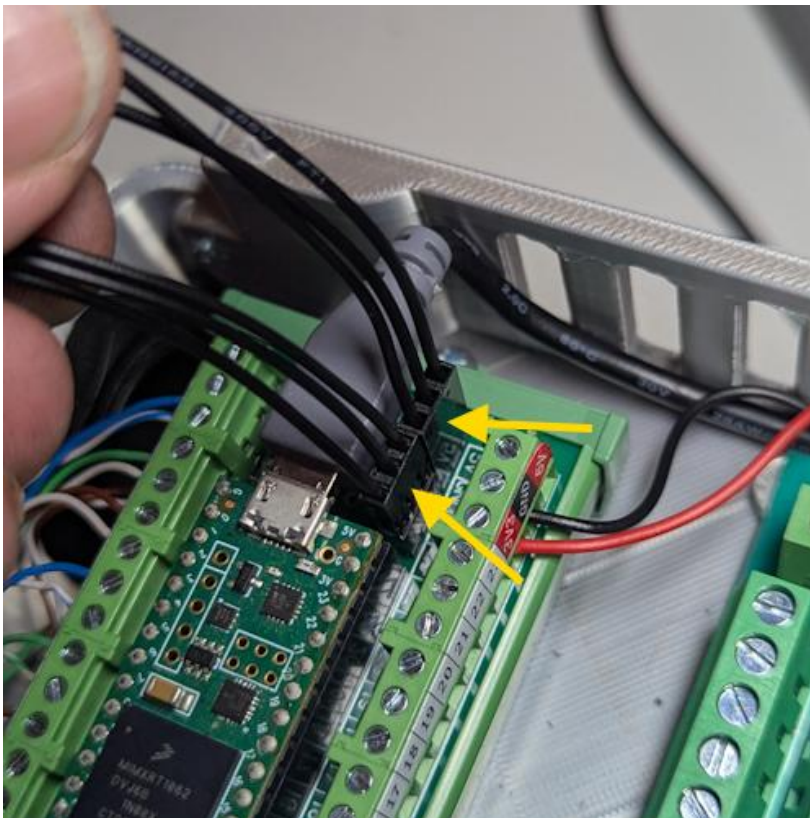

Connect (2) Dupont 2.54mm female connector leads to the (6) 5v header pins on teensy breakout board as shown in photo.

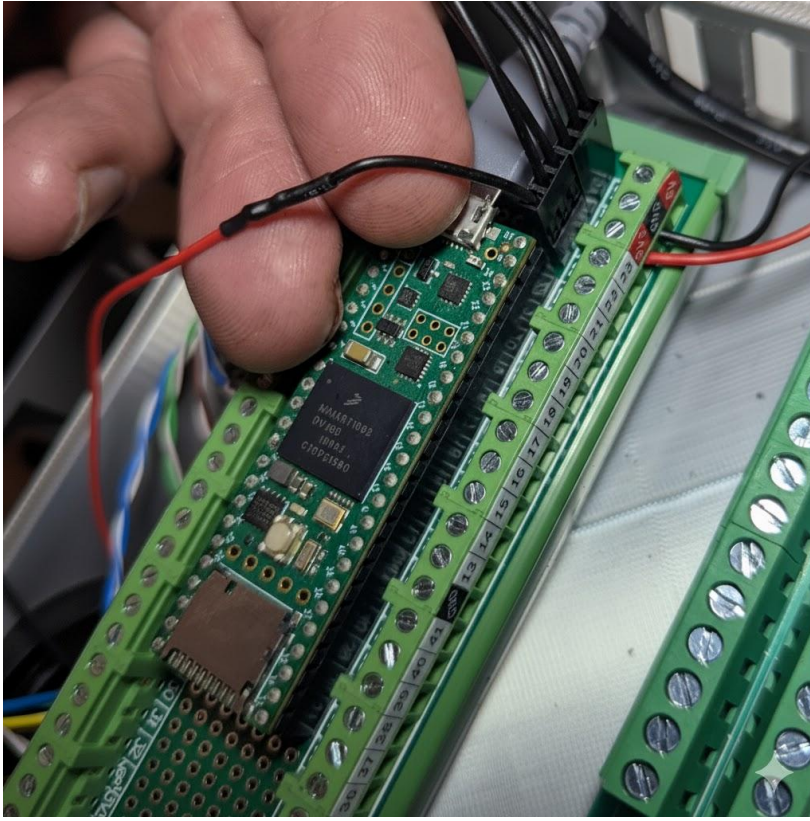

Trim wires to length as shown in photo and solder - heat shrink the red wire from the J1 encoder to the first wire on the Dupont 2.54mm 5v lead.

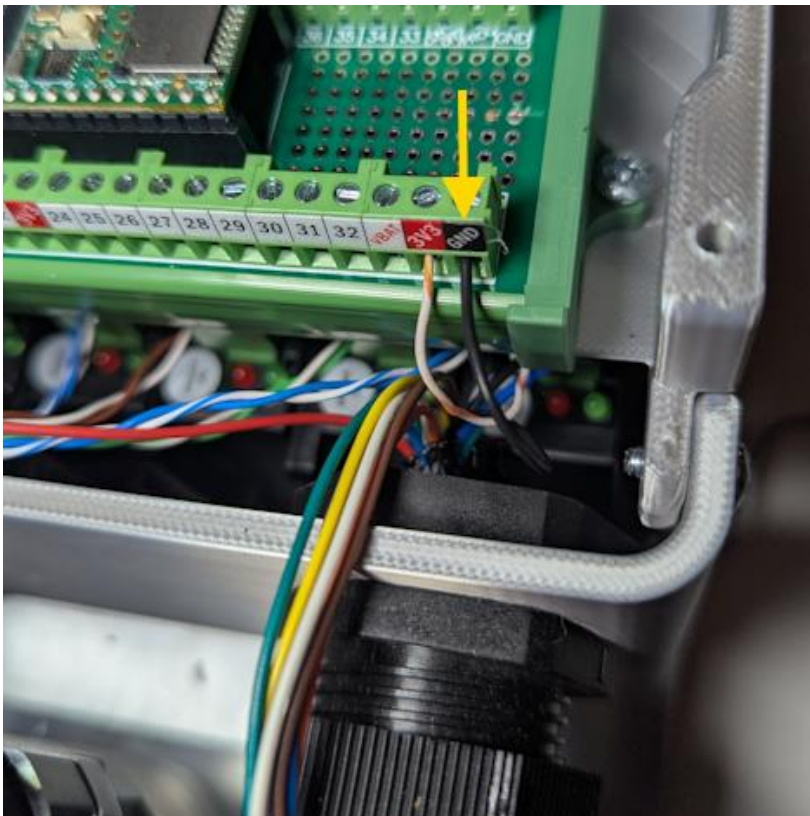

Connect the J1 encoder black wire to the Teensy4.1 GND terminal shown.

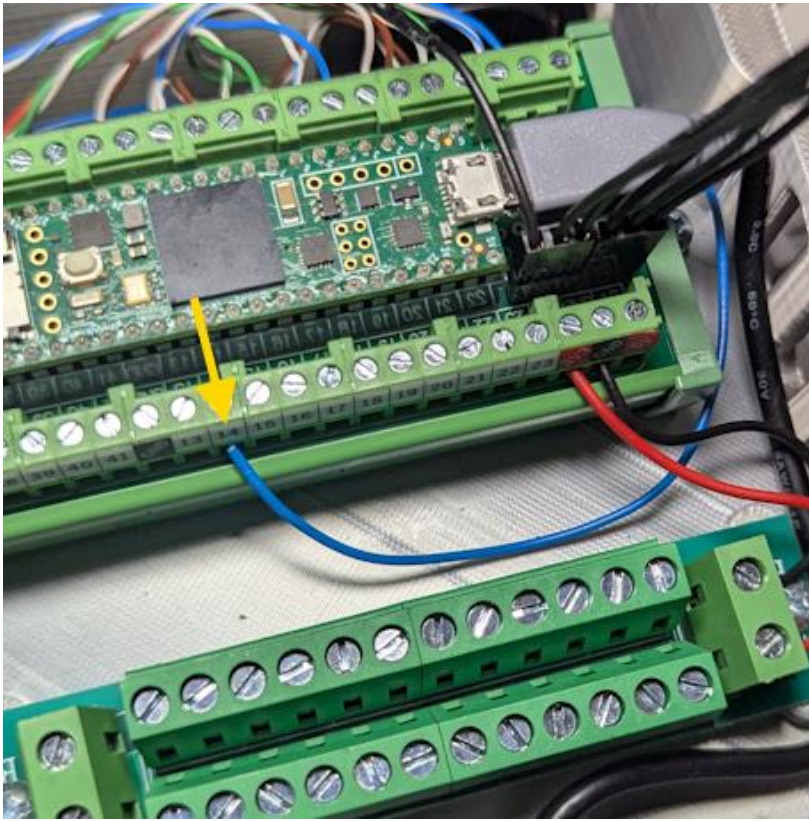

Route J1 encoder blue wire to terminal 14 as shown, cut to length. Strip wire end and connect to terminal 14.

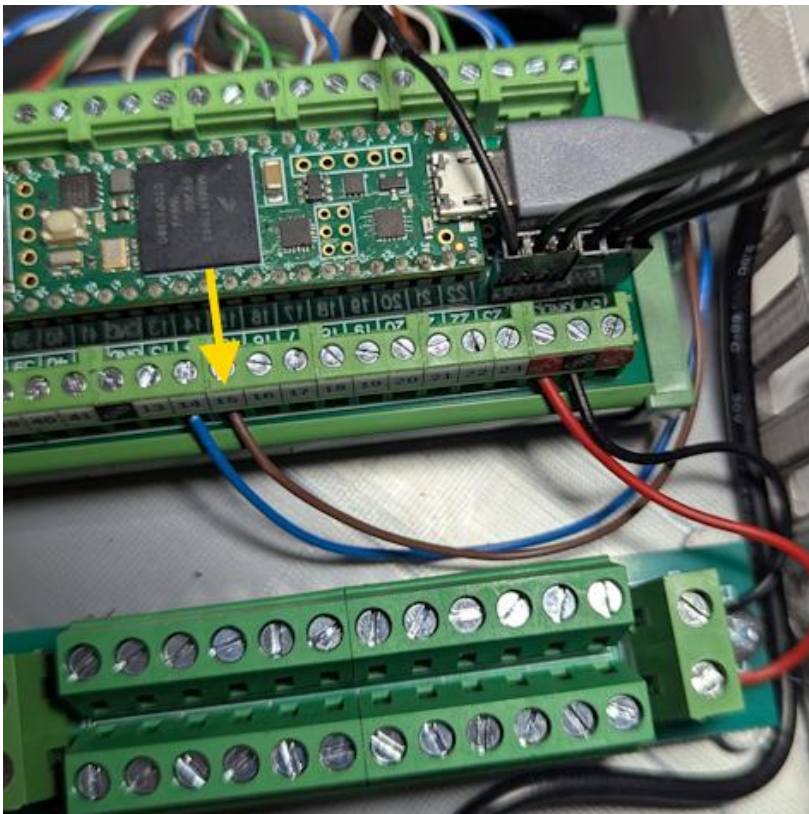

Route J1 encoder brown wire to terminal 15 as shown, cut to length. Strip wire end and connect to terminal 15.

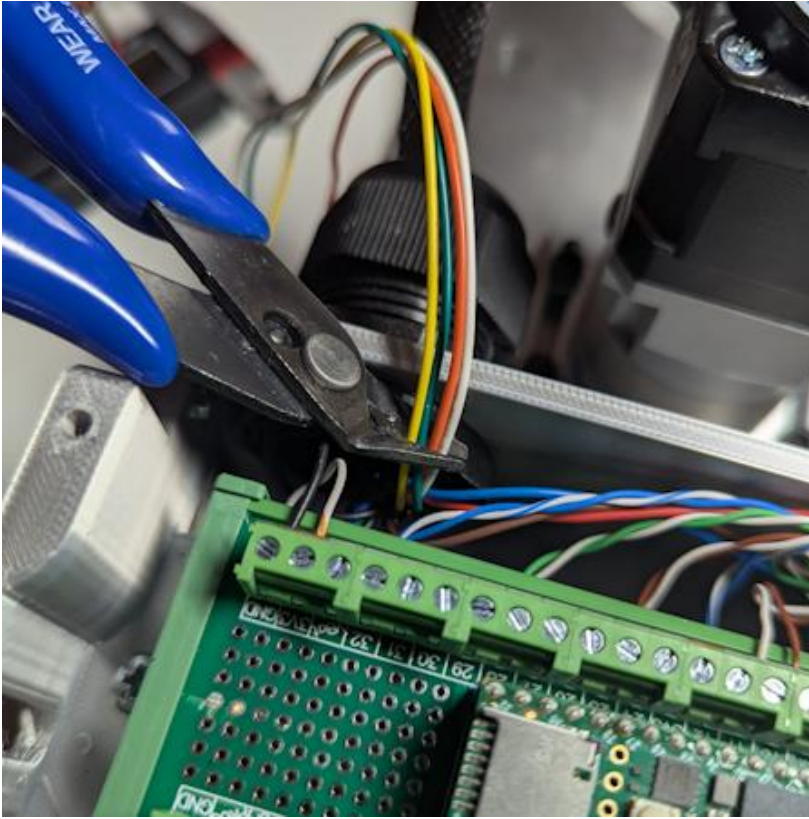

Trim and remove the J1 encoder yellow, green, orange and white wires as they are not used.

Save the remaining wires for a future step.

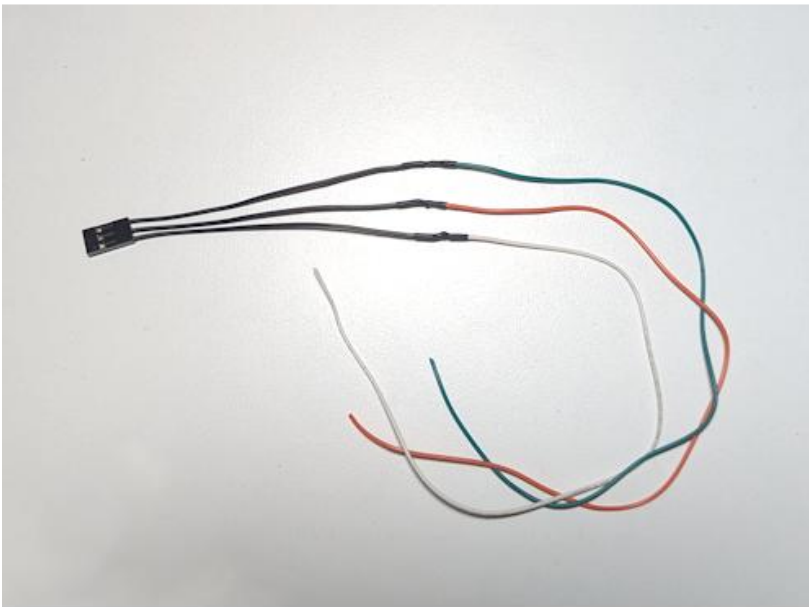

Use the remainder wire from the J1 encoder and a **Dupont 2.54 mm female 3 pin connector** lead and solder the wires as follows

- Solder the green wire to the wire coming from the **right** terminal.
- Solder the orange wire to the wire coming from the **center** terminal.
- Solder the white wire to the wire coming from the **left** terminal.

NOTE: review the general section notes on soldering and heat shrinking wire connections.





Remove adhesive back from 16cm length of EMI shielding tape and apply to the J1 encoder wires as shown.

Wrap the EMI shielding tape around the wires as shown.

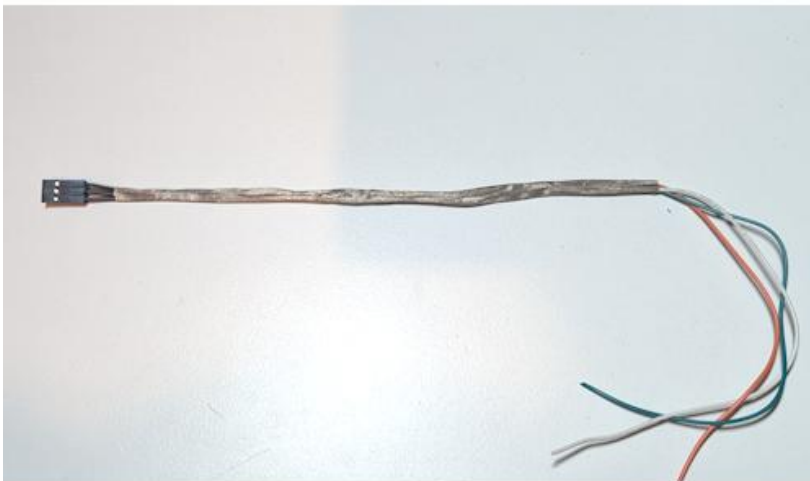

Cut length of ¼” braided sleeve to a length of 15.5cm long then route the J1 limit switch wires through the sleeve as shown.



It is recommended to use a lighter to slightly singe the ends of the braided sleeve to prevent the braided sleeve from fraying and becoming unbraided.

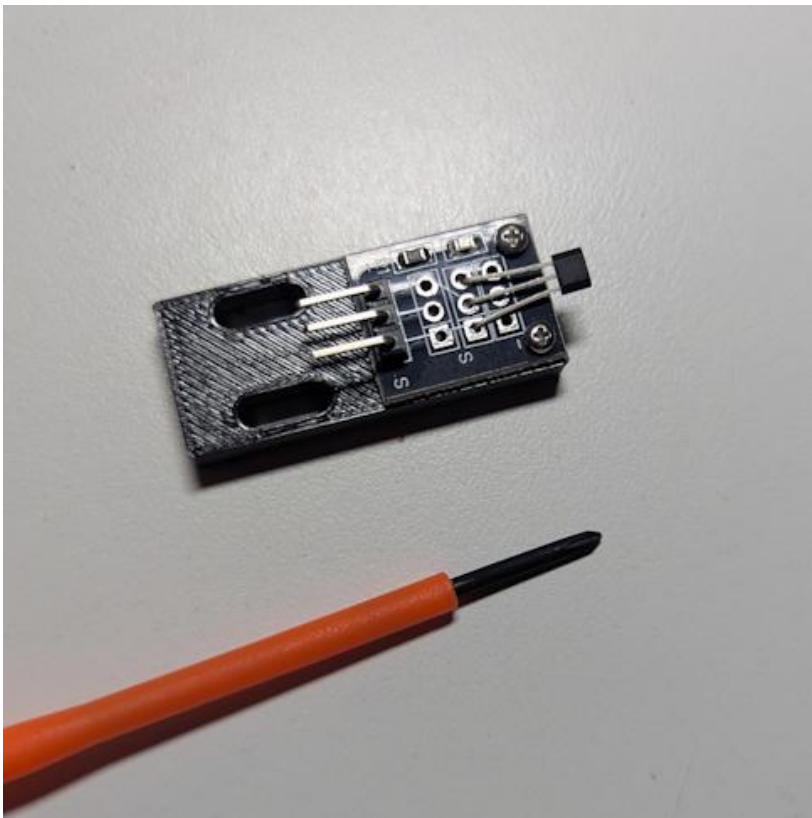

Secure 3144 Hall Effect Sensor to 3D printed Sensor Mount 1 as shown using (2) M1.6x4mm screws



Use (2) M3x14 Philips pan head screws to secure hall effect sensor and mount to the J1 Turret as shown.

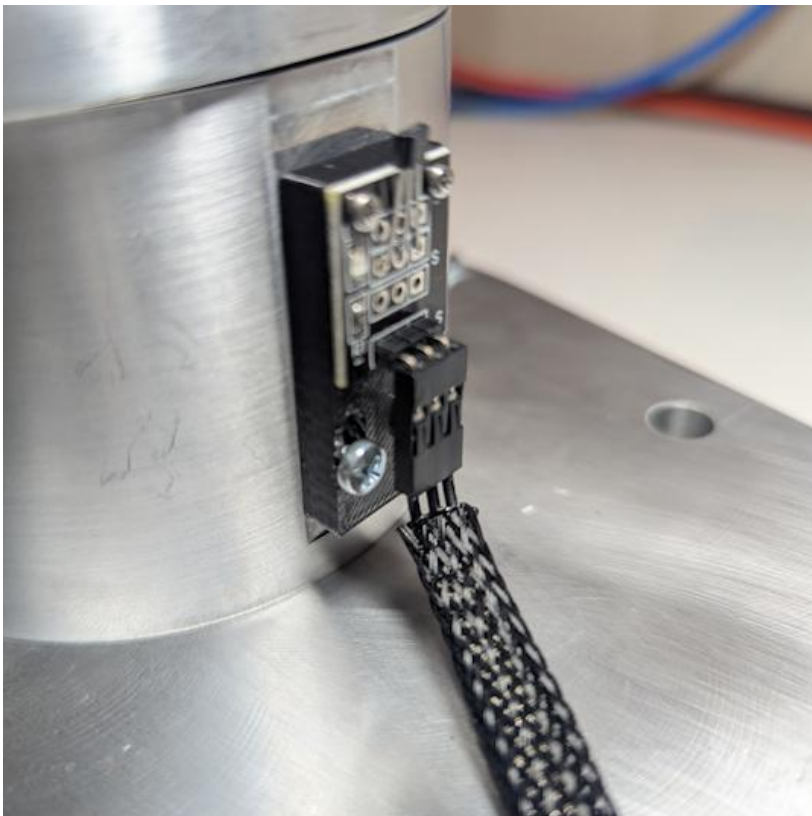

Plug the Dupont 2.54 mm female 3 pin connector wire lead into the hall effect sensor.

Make sure the terminal connected to the green wire is oriented to the right – this is the terminal marked on the hall effect sensor board with an “S” for signal.

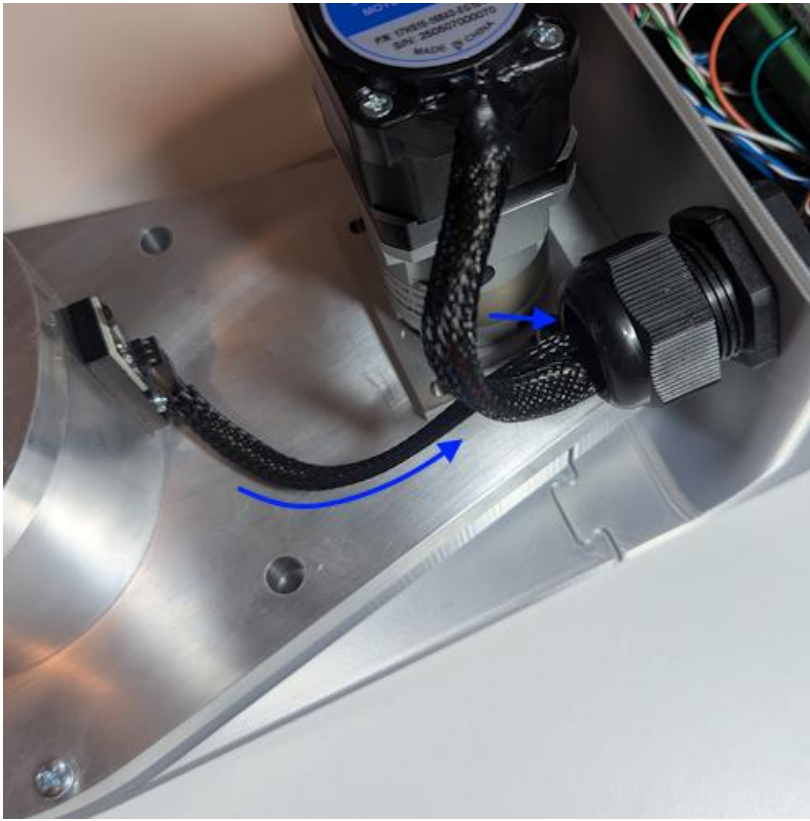

Route the hall effect wires into base enclosure as shown in photo.

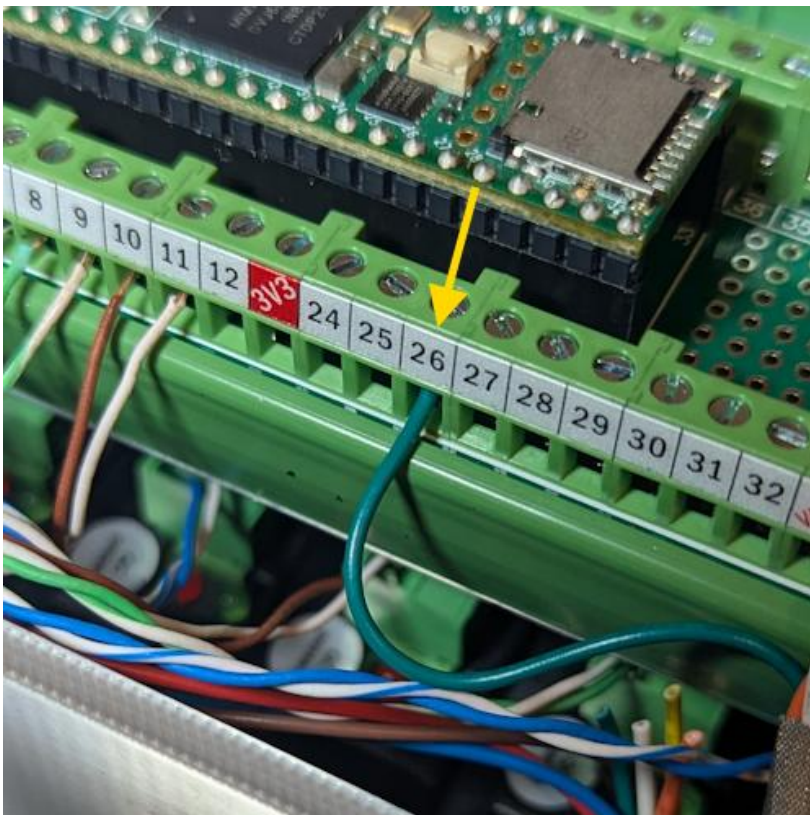

Trim the hall effect sensor green signal wire to length and connect to terminal 26 on teensy 4.1 board.

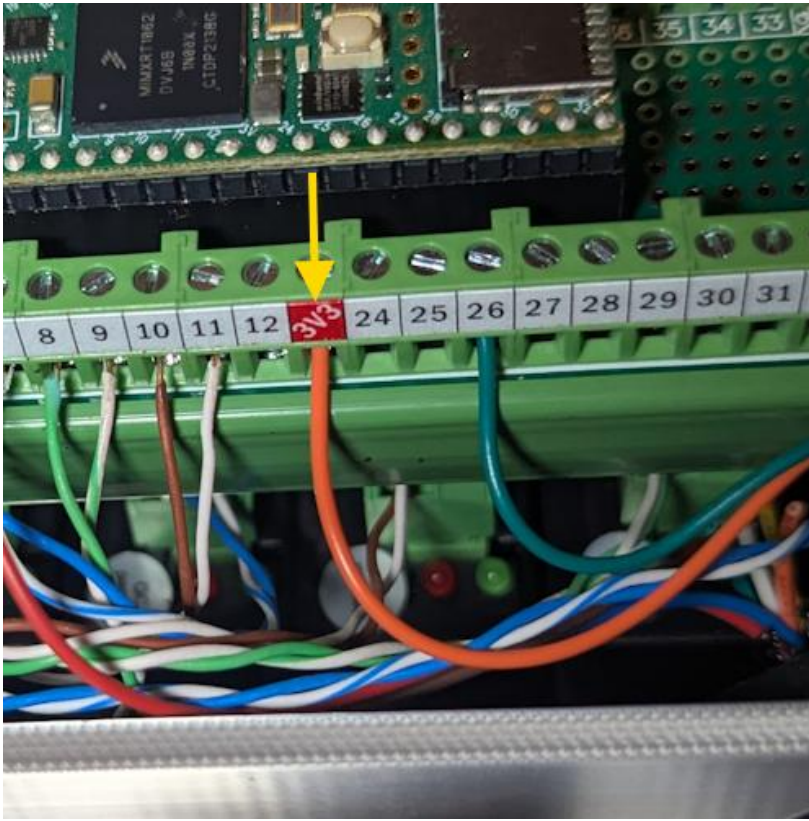

Trim the hall effect sensor orange power wire to length and connect to the 3.3v terminal on teensy 4.1 board where shown.

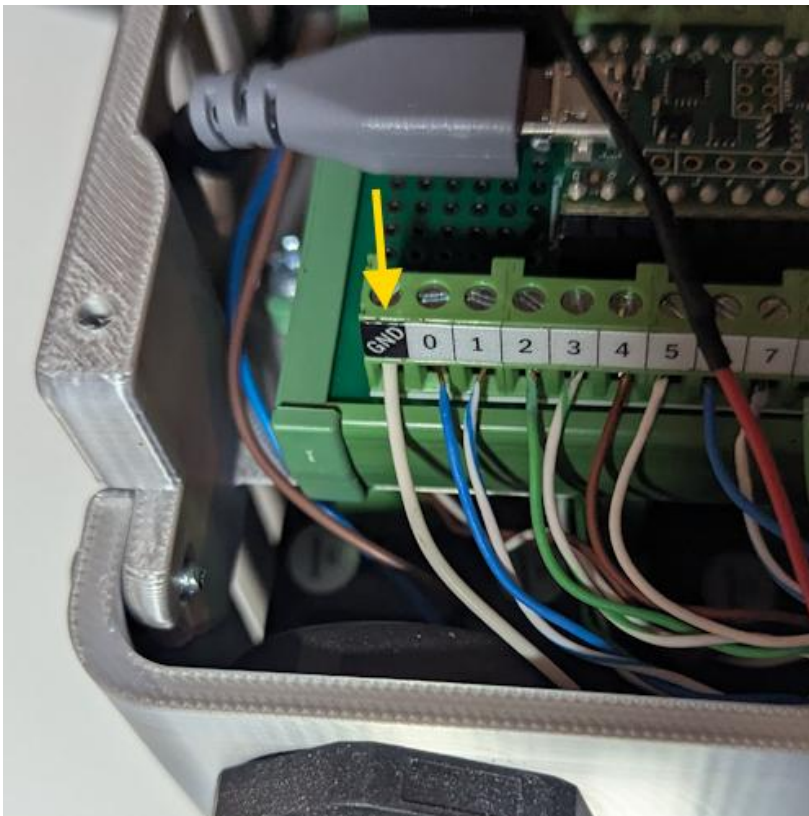

Trim the hall effect sensor white ground wire to length and connect to the GND terminal on teensy 4.1 board where shown.

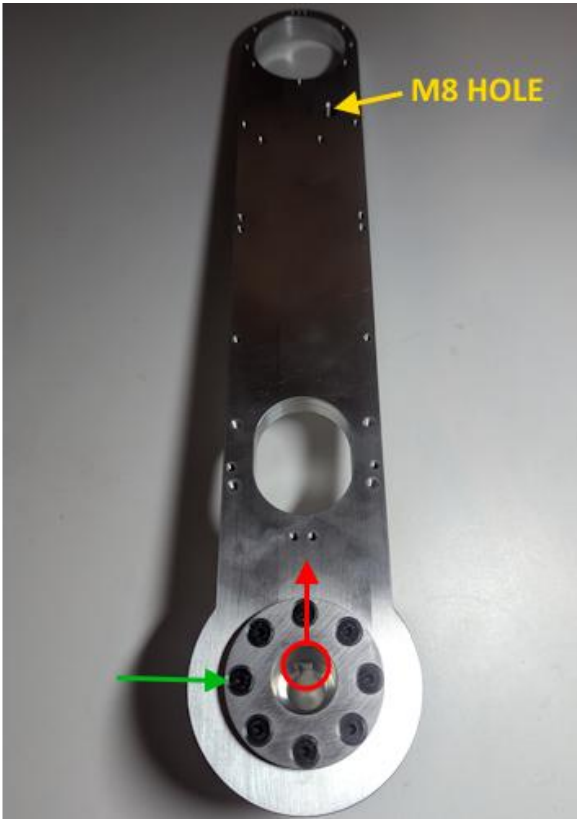

Install J2 spindle into J2 arm as shown using (8) M4x10 flat head screws. (green arrow).

Make sure J2 spindle keyway is oriented up as shown (red arrow).

Make sure M8 tapped hole is oriented to the right side as shown (yellow arrow).



Fit 3D printed J2 Bearing Cover onto #30206 bearing as shown.



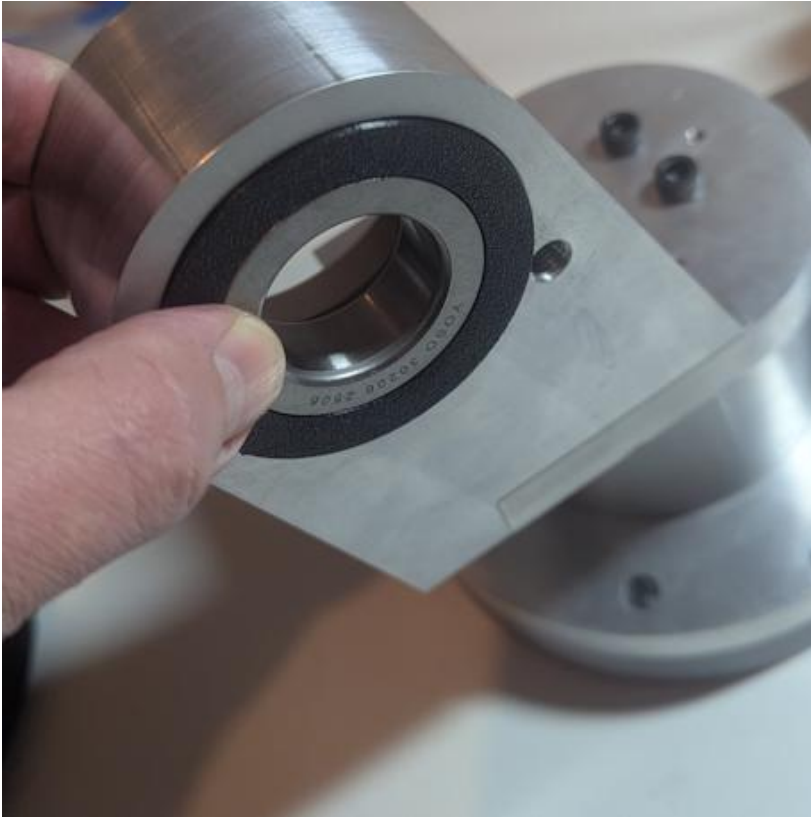

Install #30206 bearing with cover into J2 Turret as shown and hold in place.

NOTE: Apply a small amount of bearing grease to bearings prior to assembly.

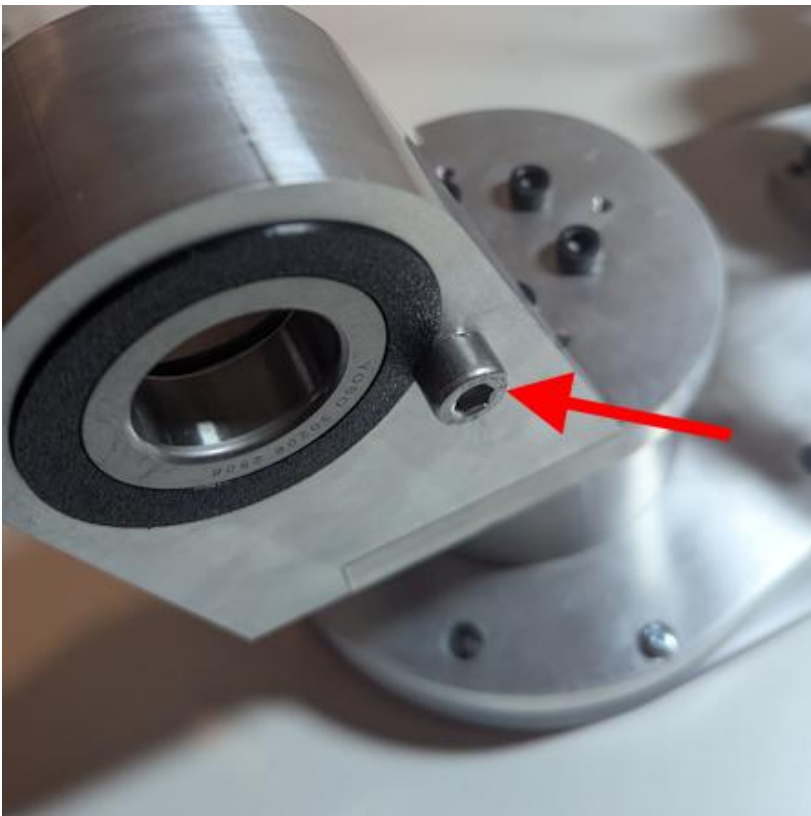

Install and tighten M8x14 socket head cap screw as shown.

NOTE: the cap screw should just slightly overlap the bearing cover and hold the bearing in place long enough for you to complete the next step.



Carefully install the J2 arm assembly as shown – insert the J2 spindle through the #30206 bearing and then hold the arm assembly in place.

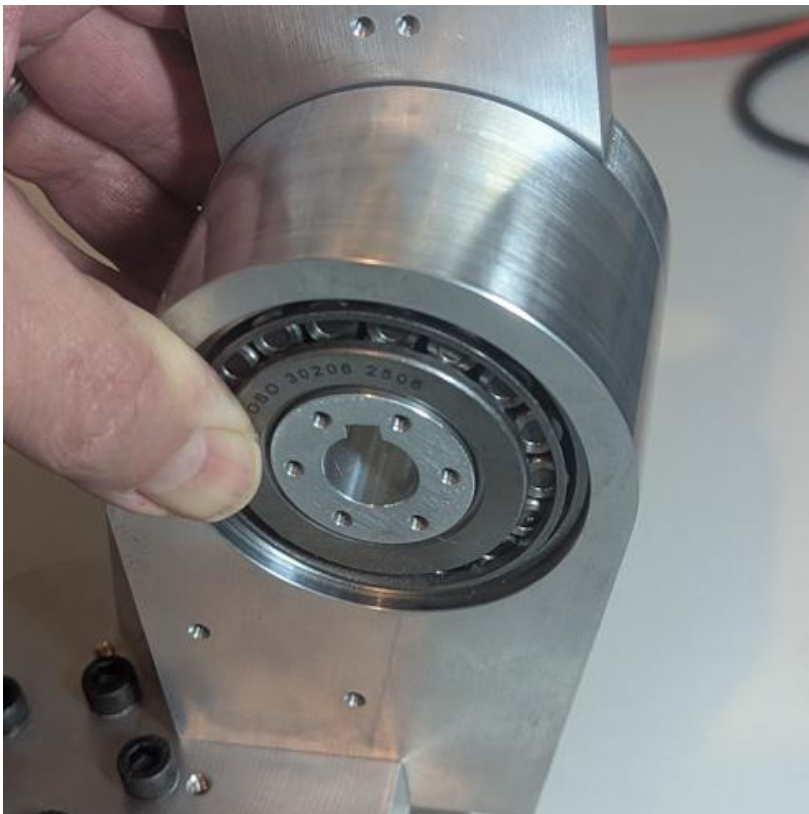

Install #30206 bearing from opposite side as shown.

NOTE: Apply a small amount of bearing grease to bearings prior to assembly.

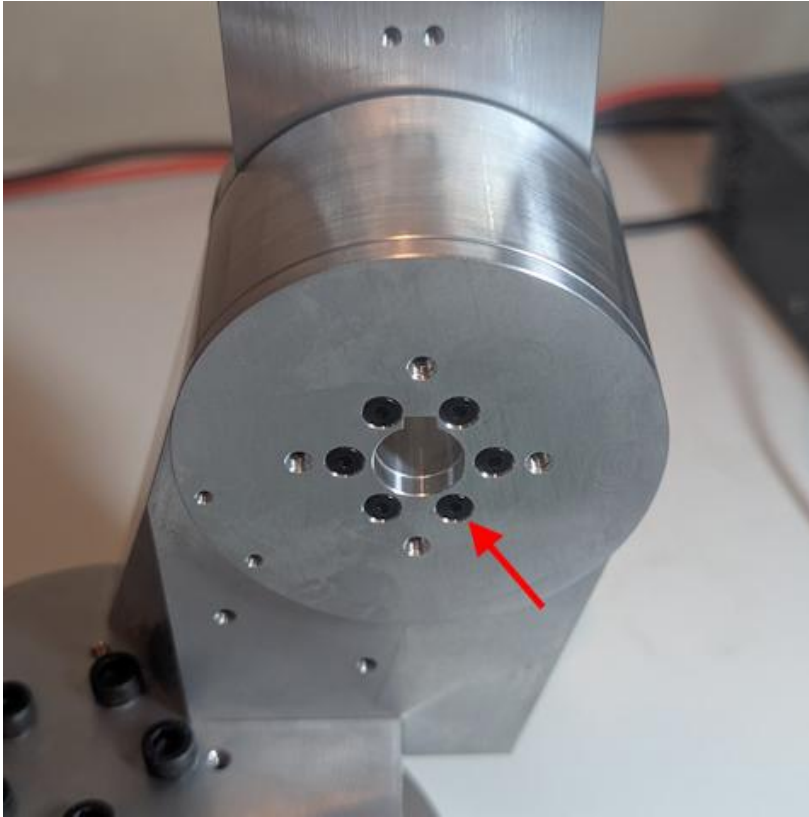

Install J2 tension ring and secure with (6) M3x10 flat head screws.

Make sure the keyway slot in tension ring aligns with keyway slot in J2 spindle.

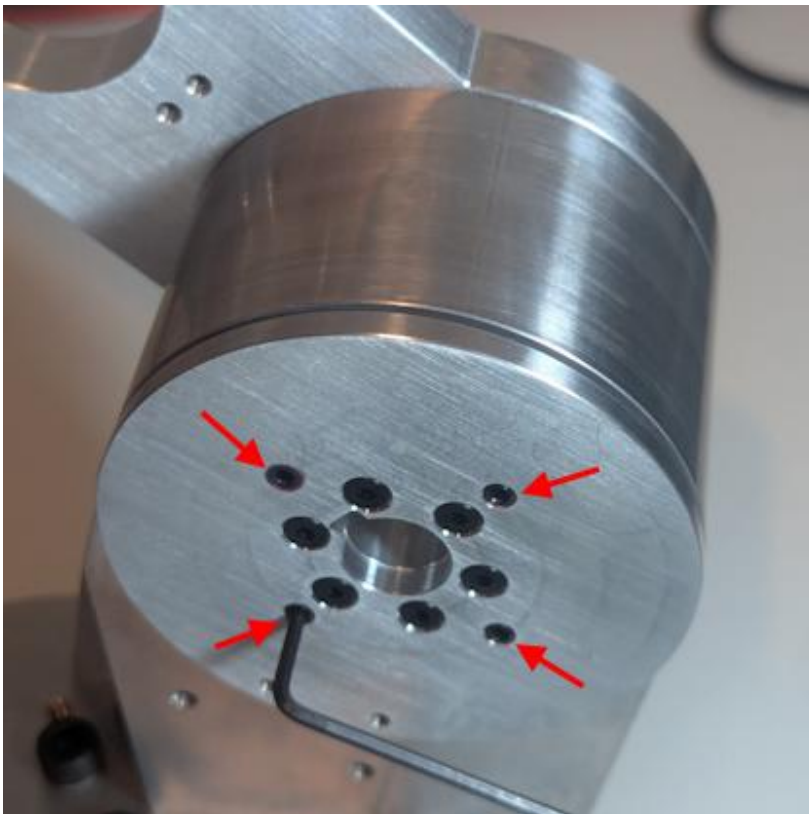

Install (4) M4x5 set screws and tighten until there is no play in J2 bearings. These set screws set the bearing.

Move the J2 arm forward and back several times and retention screws as needed.



For joint 2 cut length of continuous flex Cat6 cable to a length of 65cm long and remove outer jacket. (see overview section on jacket removal)



Remove 15cm of shielding from one end of the cable and remove 4cm of shielding from the other end. **(see overview section on removing shielding – be very careful not to cut or damage wires)**

The end with 15cm of shielding removed will be the end of the cable that is routed to the base enclosure.

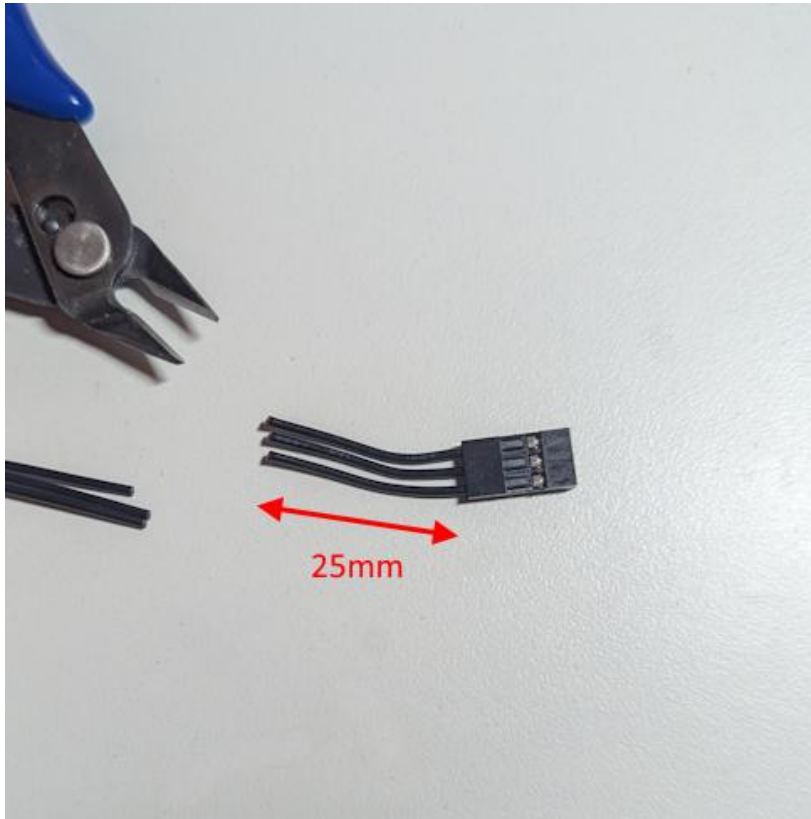

Trim wires on 2.54 mm female 3 pin connector lead leaving 25mm wire length.

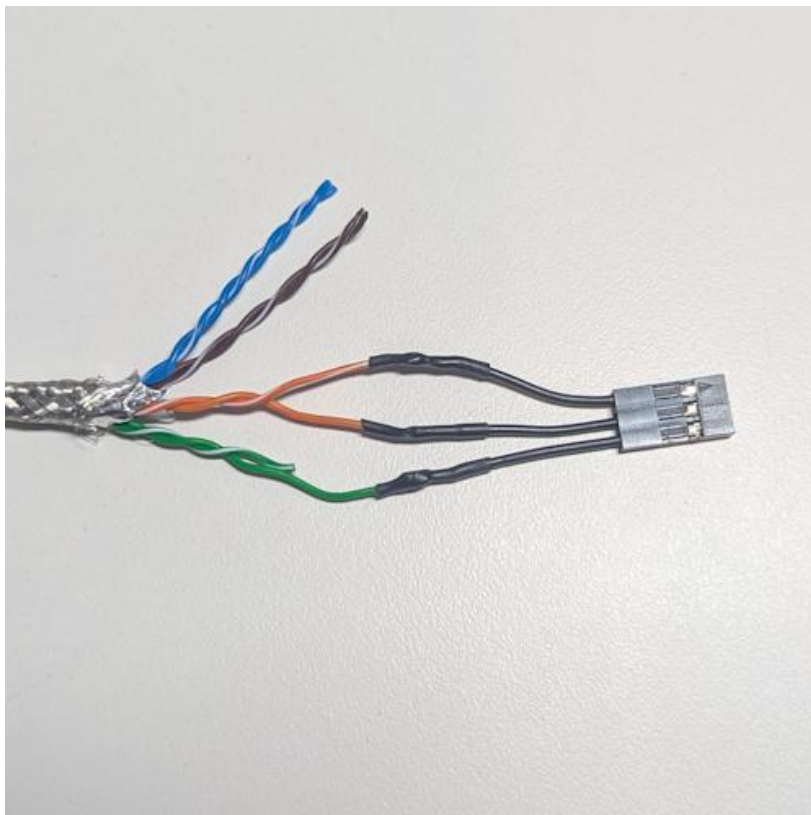

Solder and heat shrink the wires from the 2.54mm Dupont 3 pin connector to the orange and green wires on the short end of the shielded CAT5 cable that has 4cm of shielding removed.

- Solder the green wire to the wire coming from the right terminal.
- Solder the solid orange wire to the wire coming from the center terminal.
- Solder the orange white stripe wire to the wire coming from the left terminal.

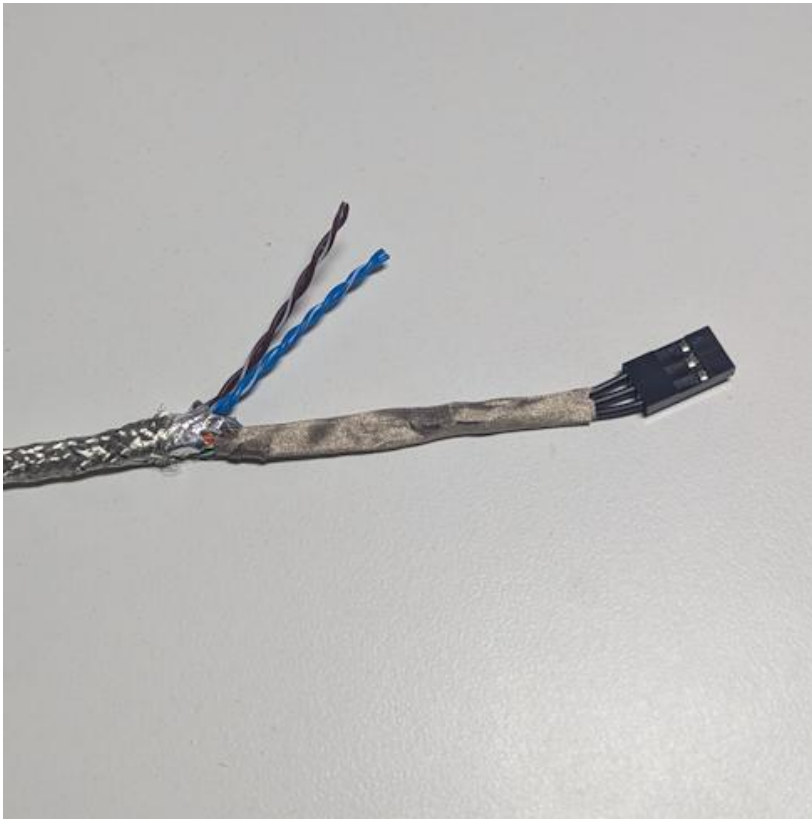

Cut a 5cm length of EMI shielding tape and wrap orange and green wires as shown.

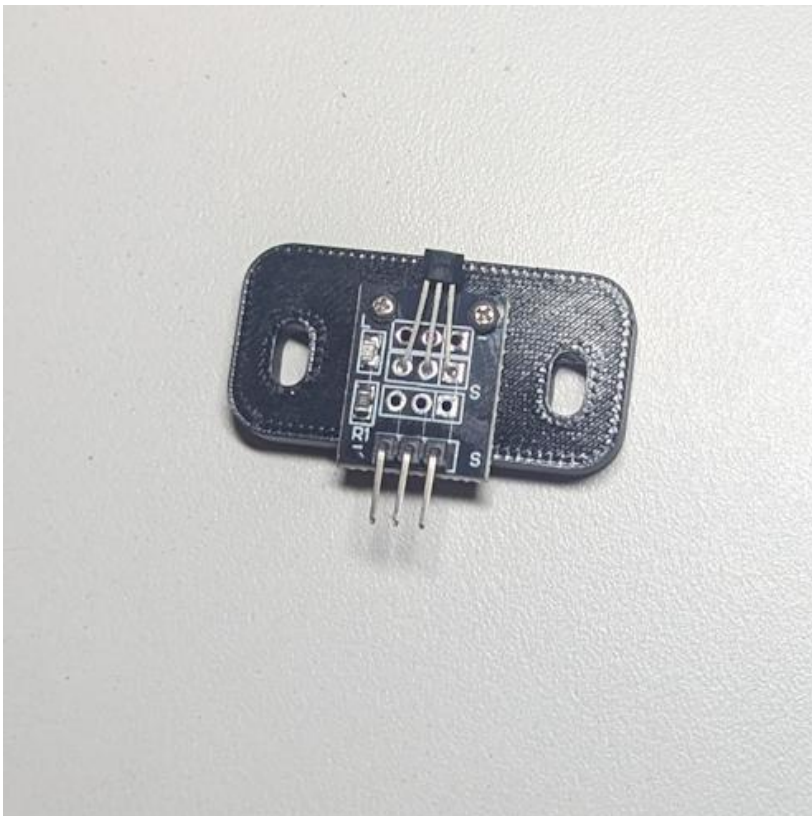

Secure 3144 hall effect sensor to 3D printed J2 sensor mount using (2) M1.6x4mm screws.

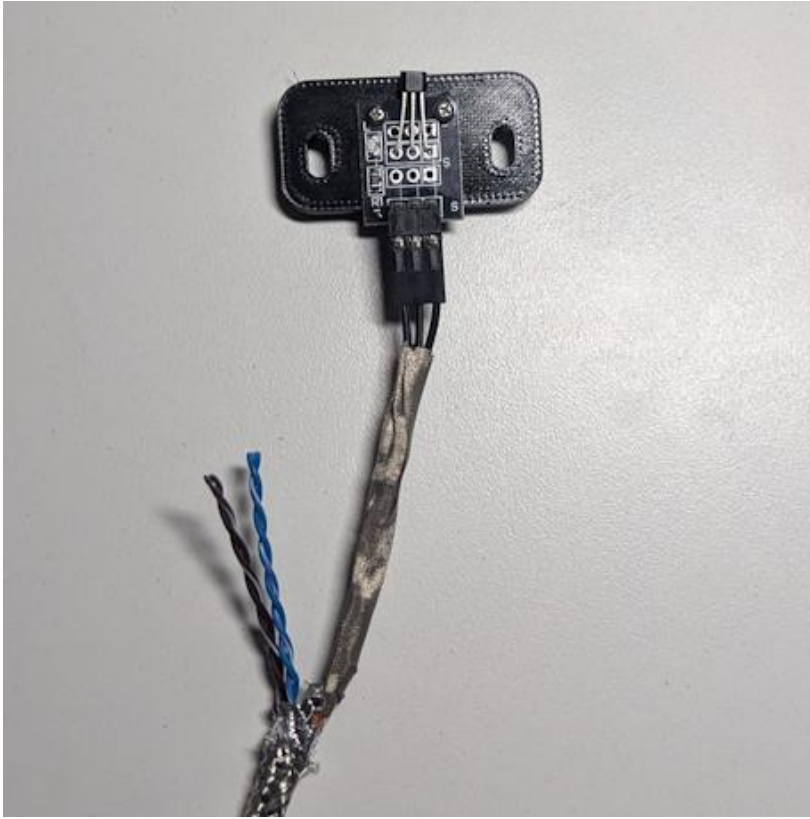

Plug dupont 2.54mm connector into hall effect sensor as shown.

Make sure the terminal connected to the green wire is oriented to the right – this is the terminal marked on the hall effect sensor board with an “S” for signal.

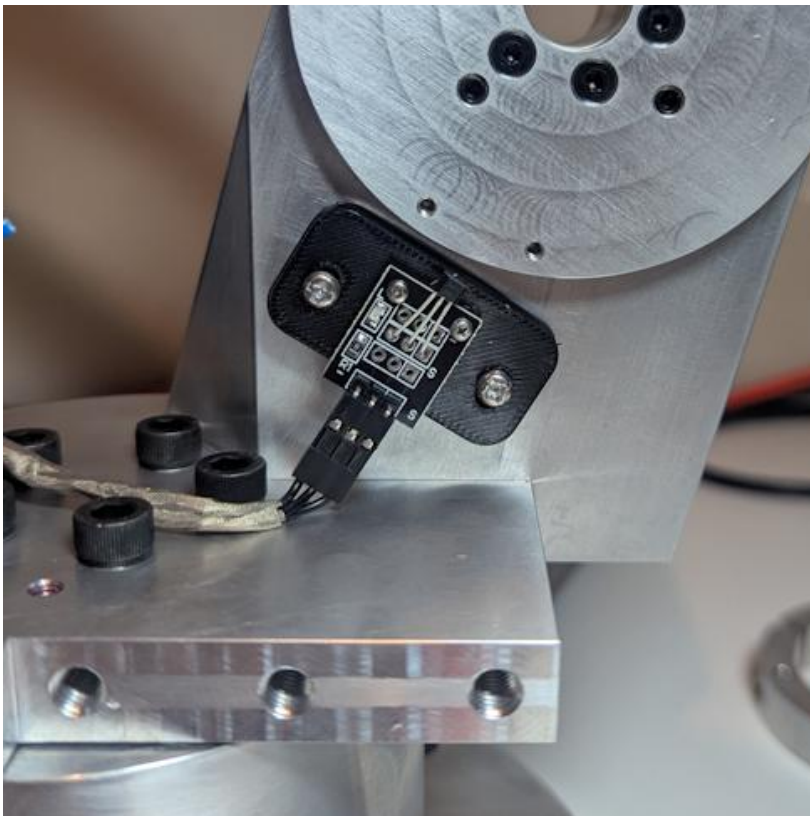

Secure the hall effect sensor and mount to the J2 Turret Housing as shown using (2) M3x10 pan head screws.



Place 4mm x 4mm magnet on the tip of a flat blade screwdriver as shown.

Hold the magnet up to a magnet polarity tester and make sure the North side of the magnet is facing out and that the south side is connected to the screwdriver.



Using flat blade screw driver, press magnet into 3D printed J2 Magnet Mount.



Use magnet polarity tester to verify the south side of magnet is facing out.

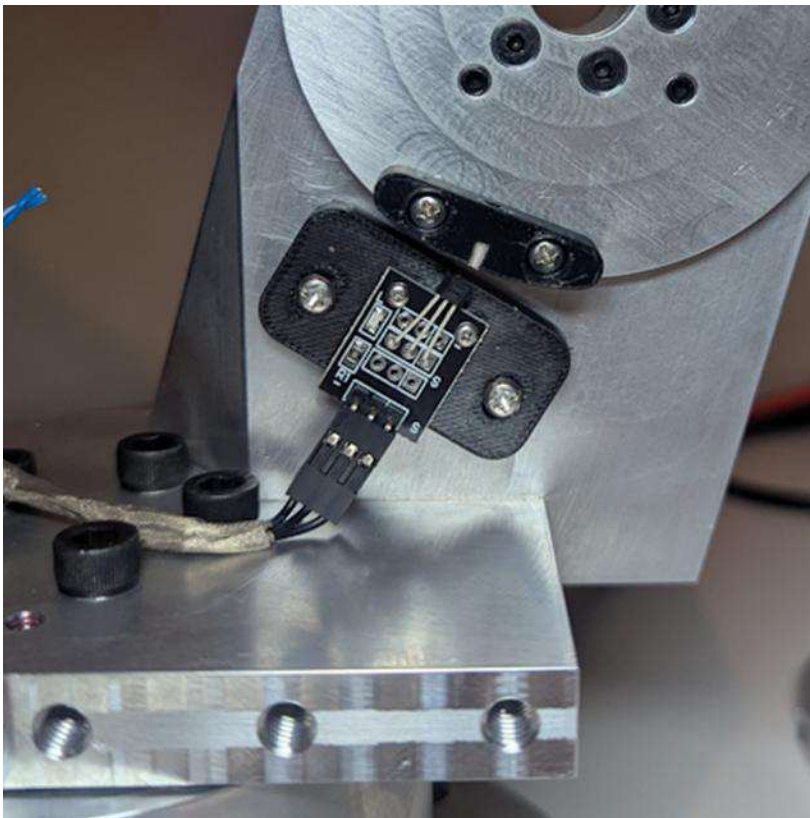

Secure J2 magnet mount to J2 Tension Ring using (2) M2.5x6 pan head screws.

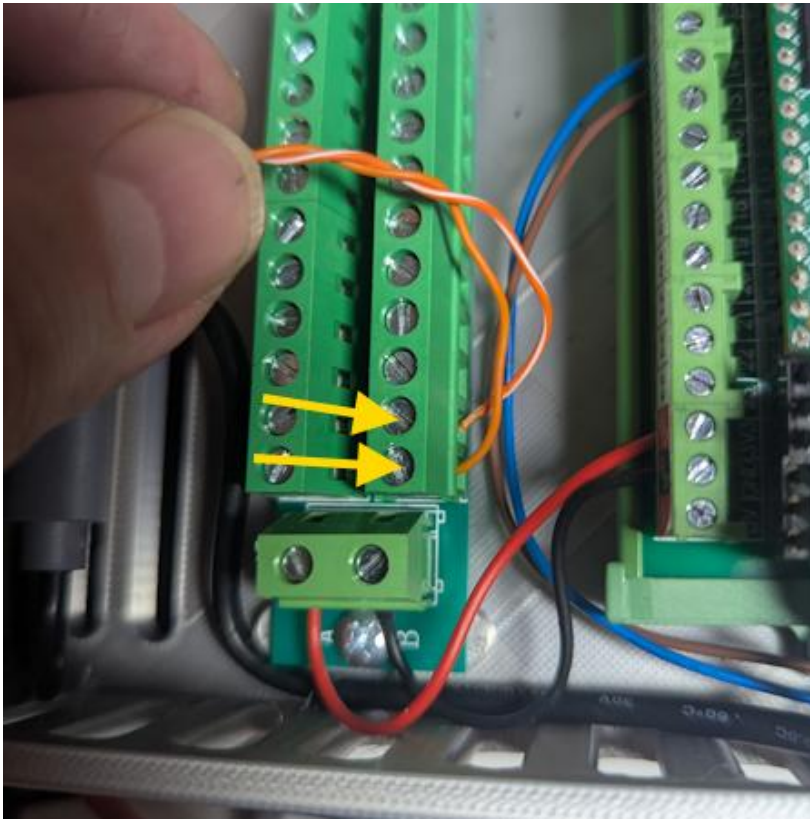

Next we need to test the hall effect sensor that was just installed.

Temporarily connect 3.3v to the sensor – connect the orange wire from the long end of the CAT5 shielded cable to terminal B1 as shown and then connect the orange-white stripe wire to the B2 terminal as shown.

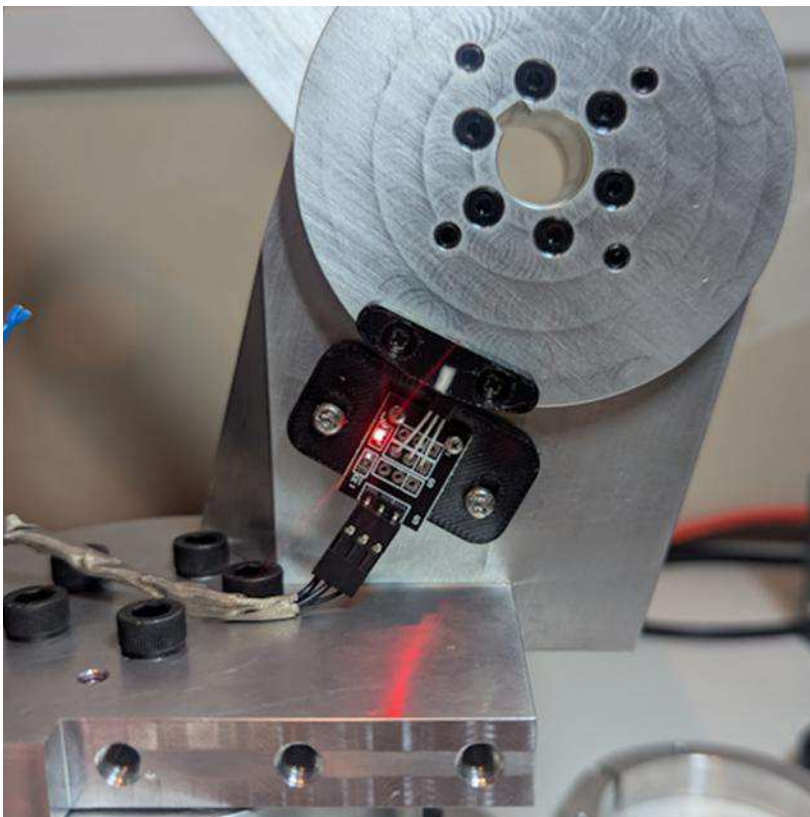

Plug USB cable from PC to the robot base to power up the Teensy4.1 board.

Rotate the J2 arm back and forth to verify the hall effect LED illuminates when the arm is in the back position.

Adjust the sensor mount position as needed and bend the sensor head leads as needed to ensure the sensor triggers reliably every time.

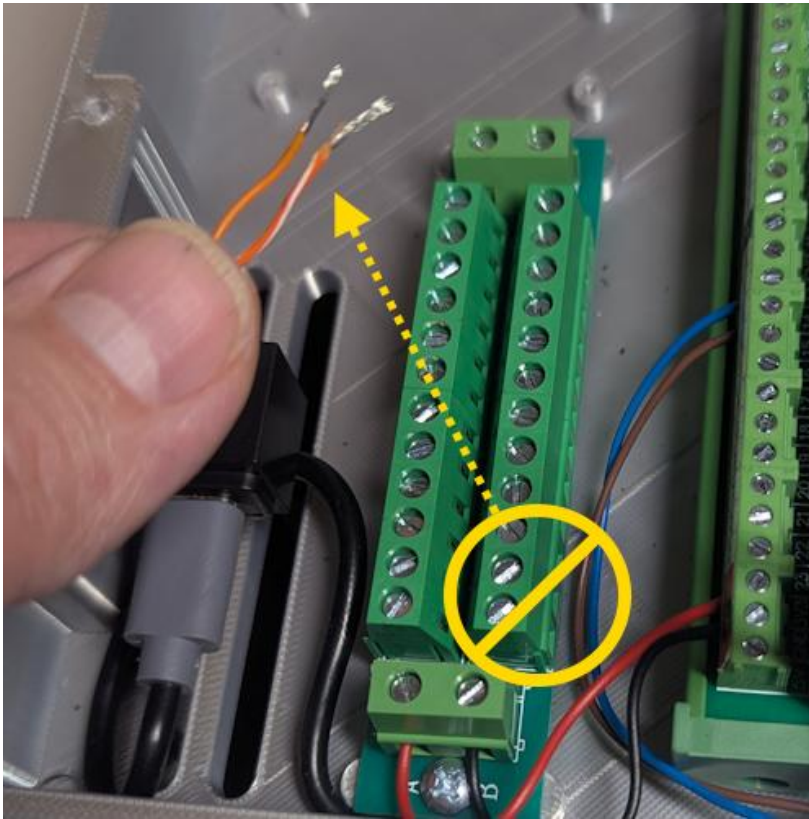

When sensor testing is complete unplug the USB cable and disconnect the orange and white wires from the 2x12 terminal board.



Verify the key in the J2 motor shaft (23HS22-2804D-YGS50-AR4) is fully seated. As shown in the photo the key should be fully inserted and measure just under 16mm.



If you find the key is not fully inserted, place layers of electrical tape on bench vice jaws – tighten vise as shown to fully press key into place.

DO NOT USE A HAMMER



Remove one of the J4 cap screws that secures the motor to the gearbox housing.



Replace the screw you just removed with a M4x45 fully threaded pan head screws.

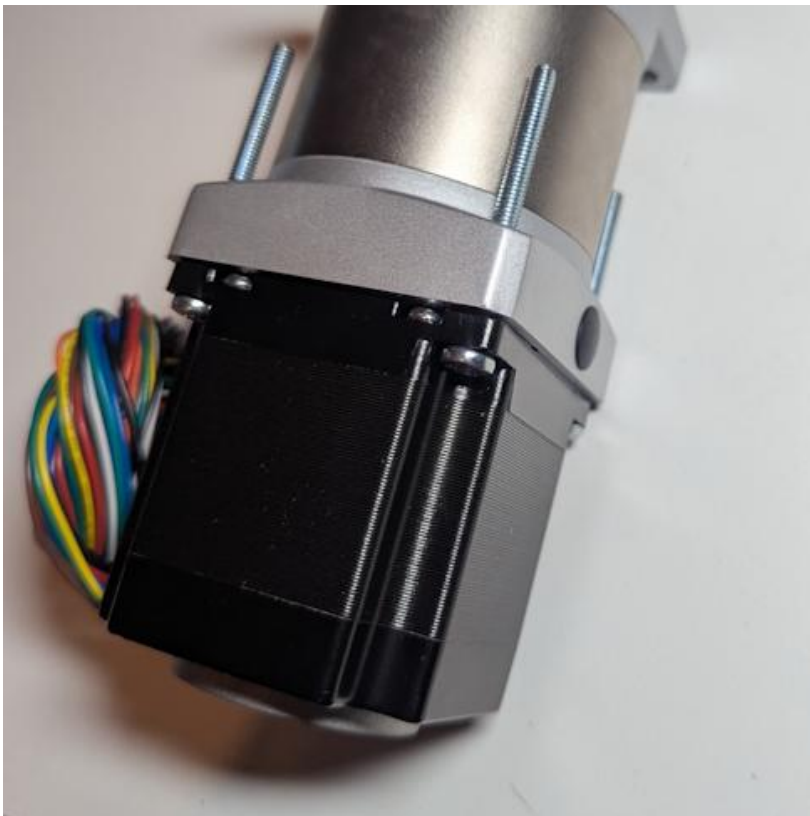

Remove the remaining (3) cap screws and replace with M4x45 fully threaded pan head screws.

All (4) fasteners securing the J2 motor to the gearbox should now be M4x45 pan head screws.

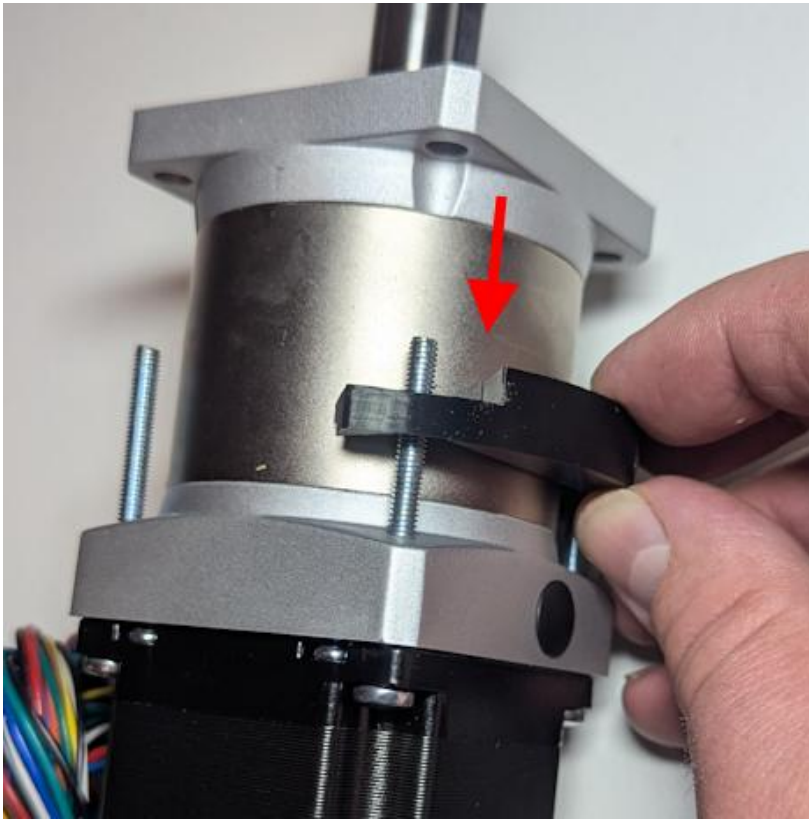

Slide J2 Motor Spacer Part 1 over M4 screws as shown. Note the motor wires are oriented on the left side of motor.



Slide J2 Motor Spacer Part 1 all the way down into position against gear box shoulder. Note the motor wires are oriented on the left side of motor.



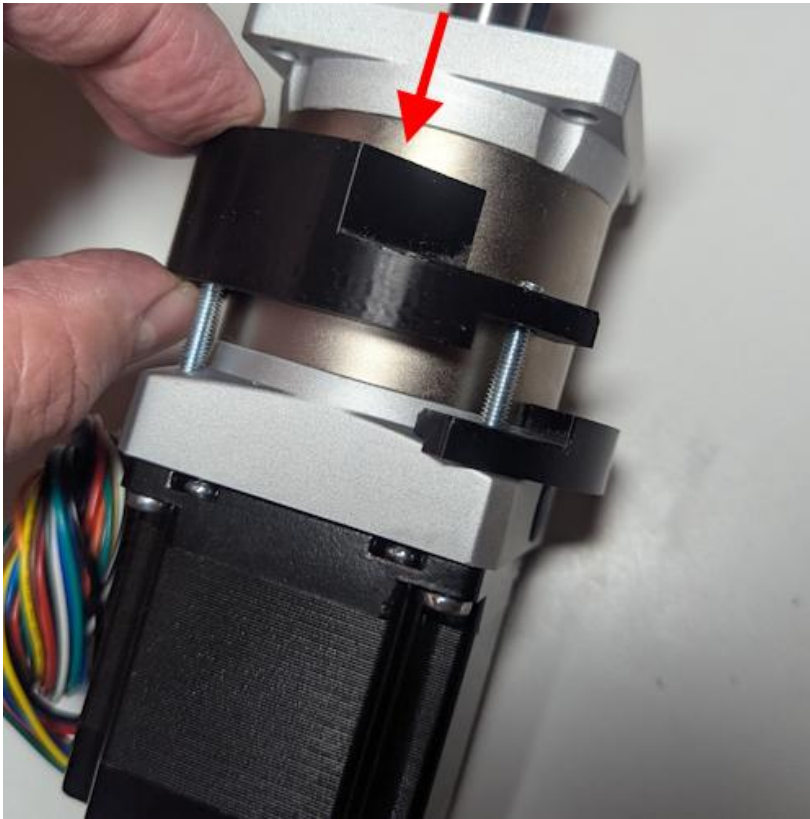

Slide J2 Motor Spacer Part 2 over M4 screws as shown. Note the motor wires are oriented on the left side of motor.

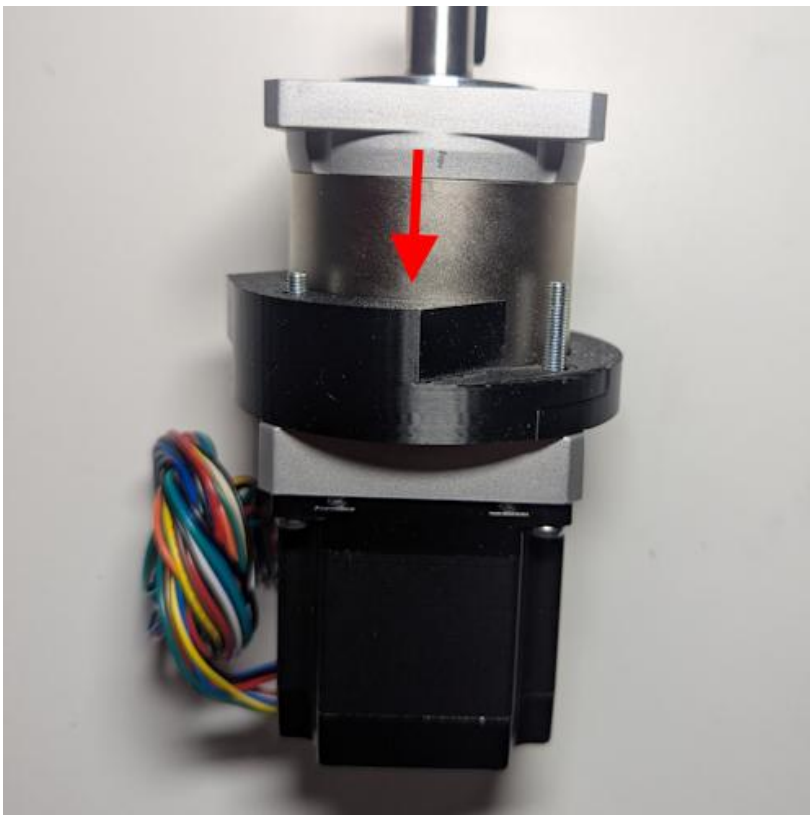

Slide J2 Motor Spacer Part 2 all the way down into position against gear box shoulder. Note the motor wires are oriented on the left side of motor.

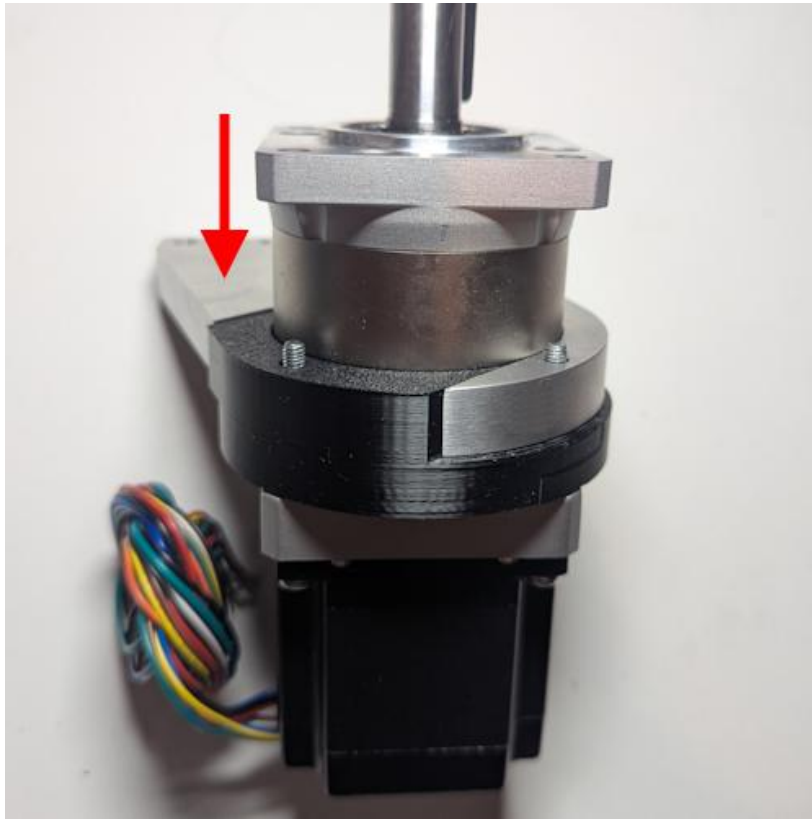

Slide J2 Motor Support over M4 screws as shown and up against the 3D printed motor spacer.

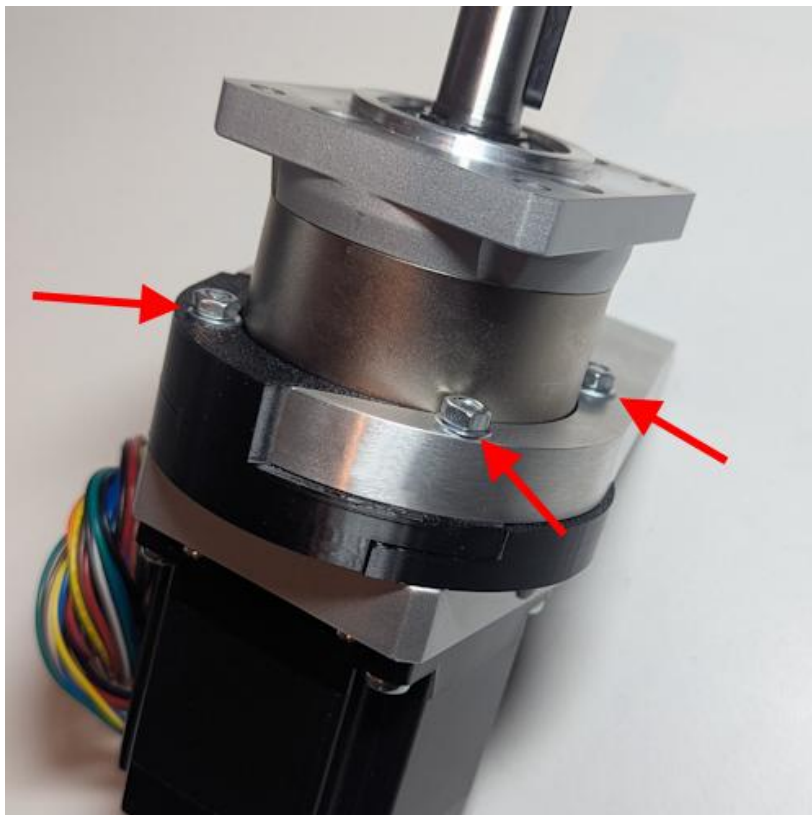

Install (4) M4 washers and nuts over each of the M4 screws and tighten.

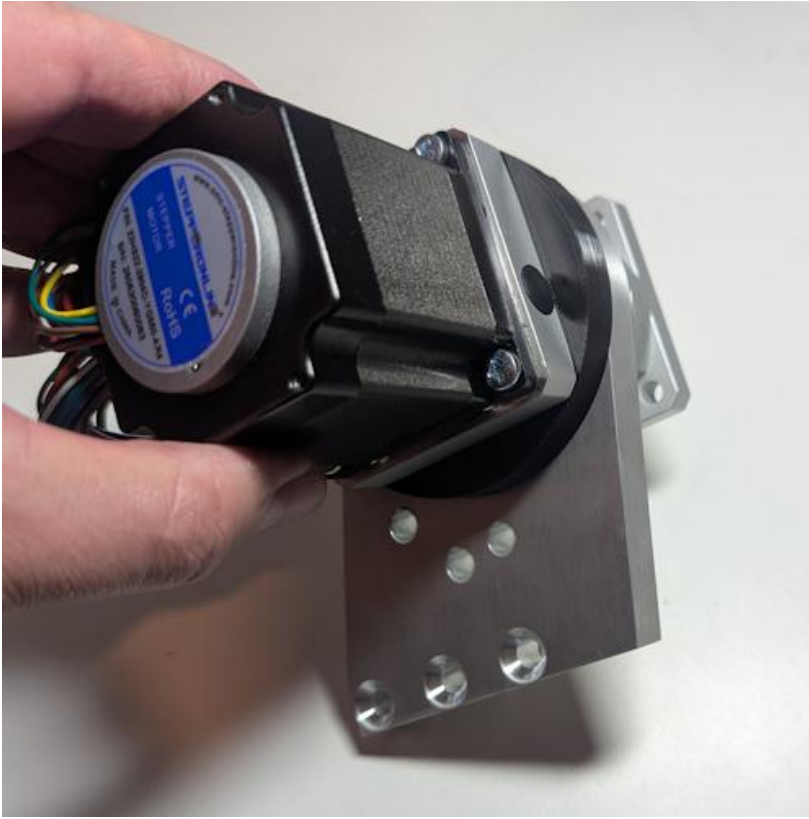

Once the motor, spacers and motor mount are assembled it should look like this photo.



Install 23HS22-2804D-YGS50-AR4 gear box into J2 arm assembly as shown.

The 14mm gearbox shaft with key needs to be inserted into the J2 spindle - **make sure the key is fully pressed into shaft** – you will have trouble inserting shaft if key is not fully pressed in.

You may need to use a soft rubber mallet to insert motor, do not tap on motor, instead hold the motor firmly in one hand and use mallet to softly tap on the J2 arm and tap the entire lower assembly toward the motor that you are holding firmly (pushing toward assembly as you are tapping).

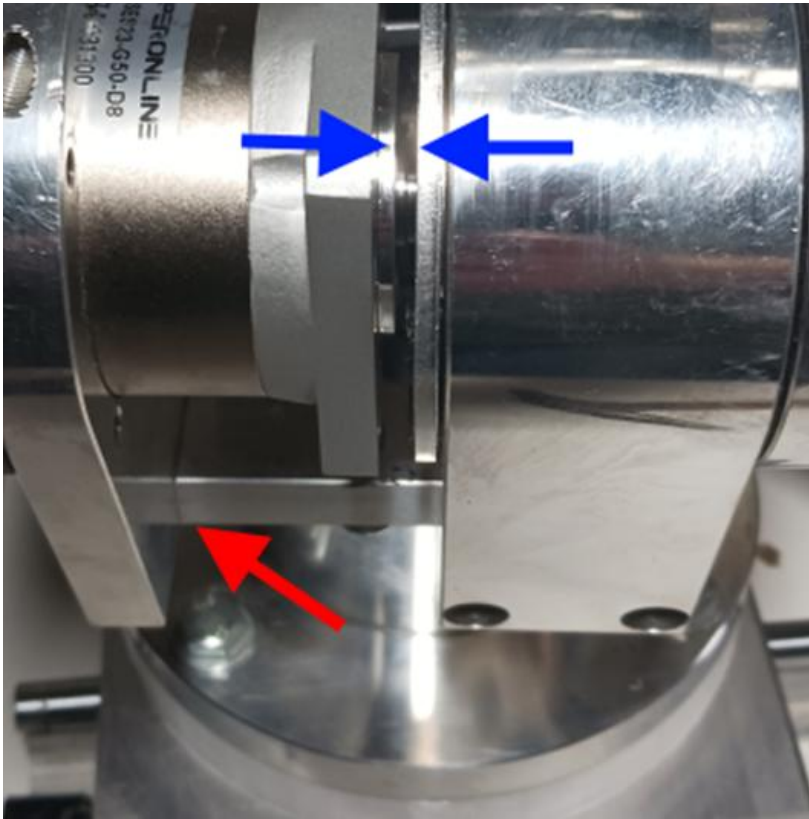

Once the gearbox is fully in place there should be an approx. 2mm gap between the J2 gearbox motor shoulder and the J2 tension ring as indicated by the blue arrows.

The J2 motor mount should be flush to the J1 platform as indicated by the red arrow.

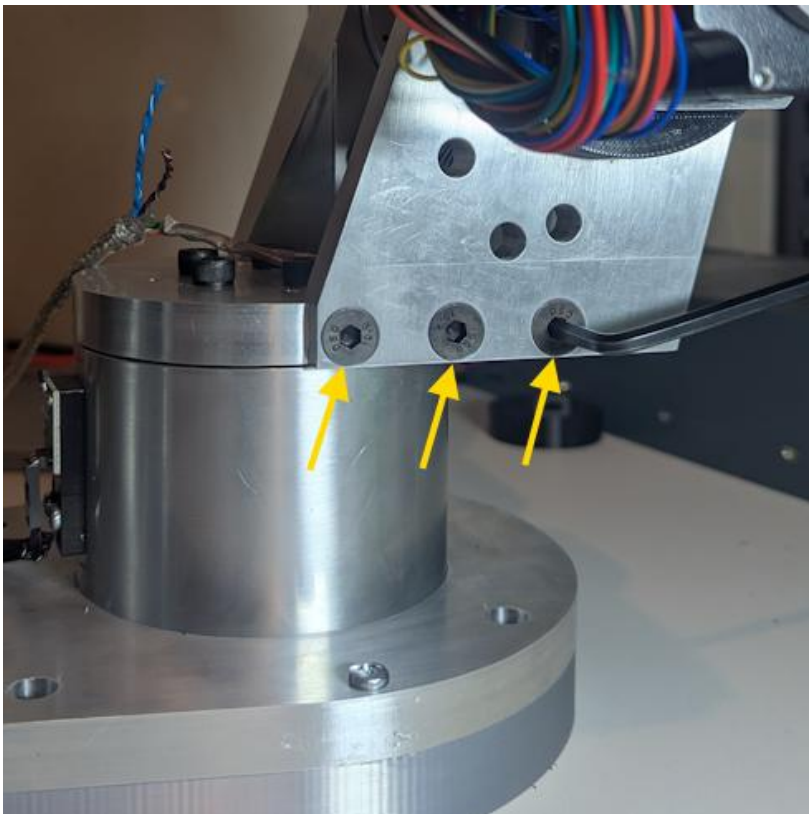

Install and tighten (3) M6x18 flat head screws securing the J2 motor mount plate to the J1 base platform.

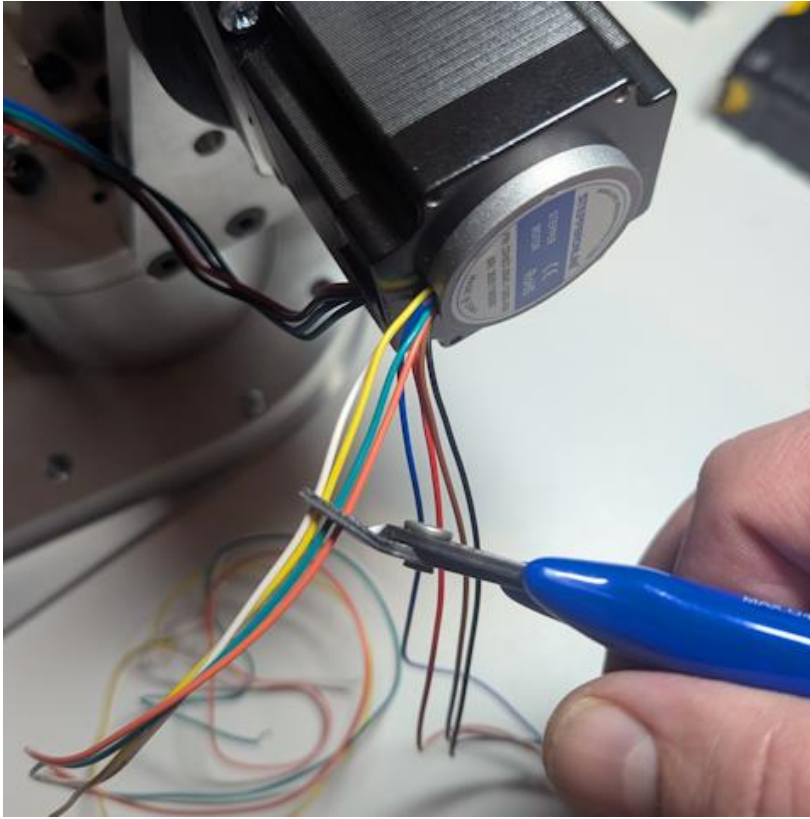

On the J2 motor separate the encoder wires from the motor wires,

Trim the white, yellow, green and orange encoder wires as shown - they are not used.

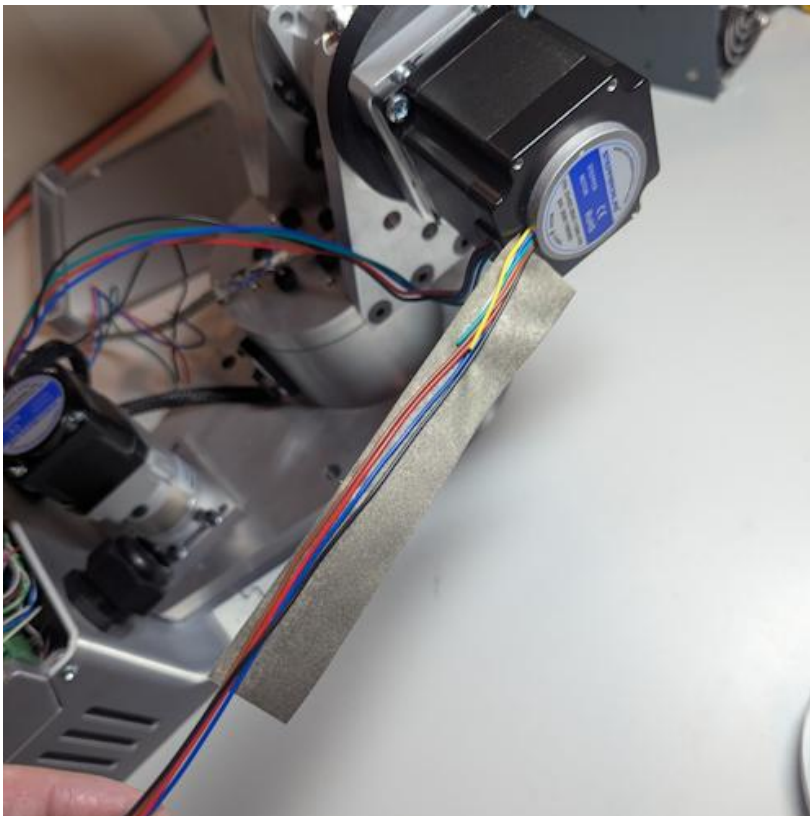

Remove adhesive back from 14cm length of EMI shielding tape and apply to the J2 encoder wires as shown.

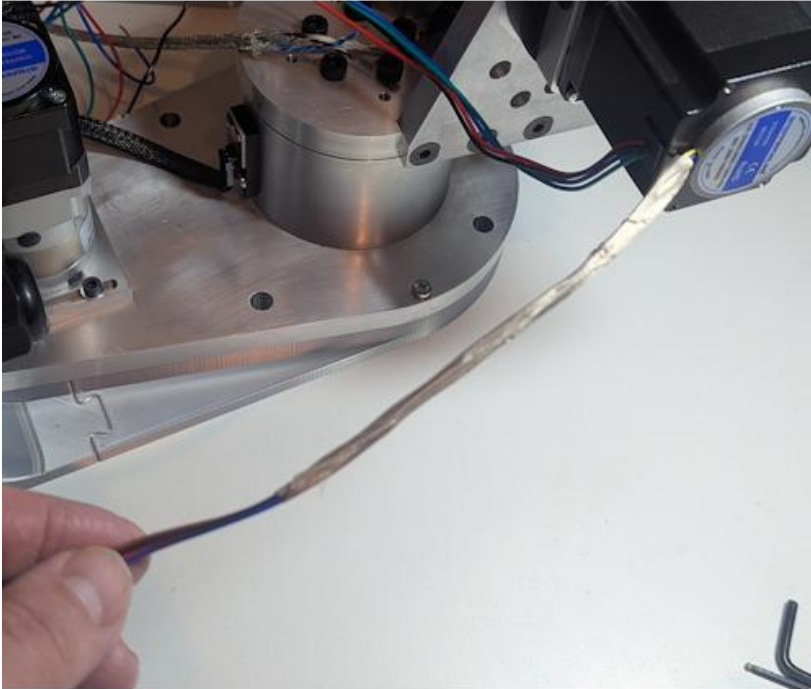

Wrap the EMI shielding tape around the wires as shown.

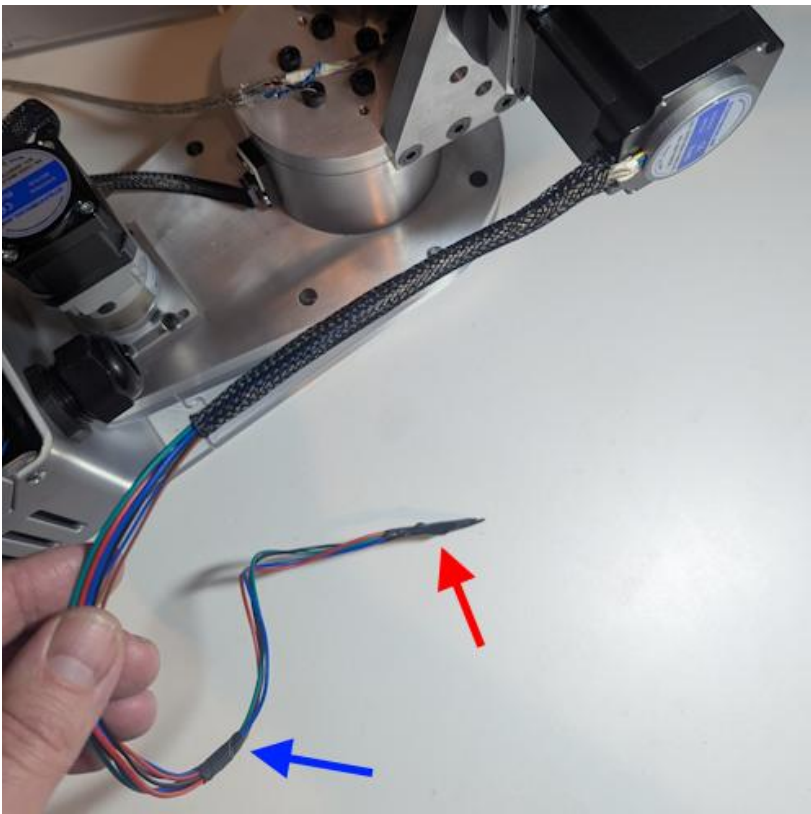

Cut length of ¼" braided sleeve to a length of 15cm long then route J2 motor and encoder wires through the sleeve.

NOTE: prior to feeding the wires through-

Tape the ends of the motor wires (red arrow) to make it easier to feed then through the braided sleeve.

Trim the encoder wires 10cm to 15cm shorter than the motor wires so they can be easily differentiated from the motor wires and tape them to the motor wires as shown (blue arrow)

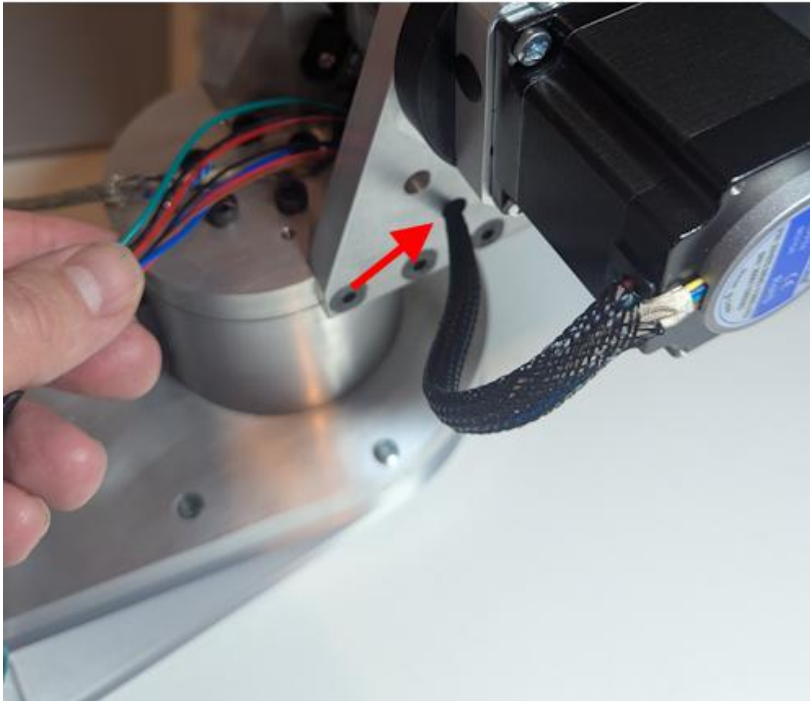

Feed the J2 motor and encoder wires through the J2 motor support plate as shown through the hold indicated by the red arrow.

NOTE the other 2 holes in the support plate are screwdriver access holes to reach the hall effect sensor fasteners if it ever needs to be removed.

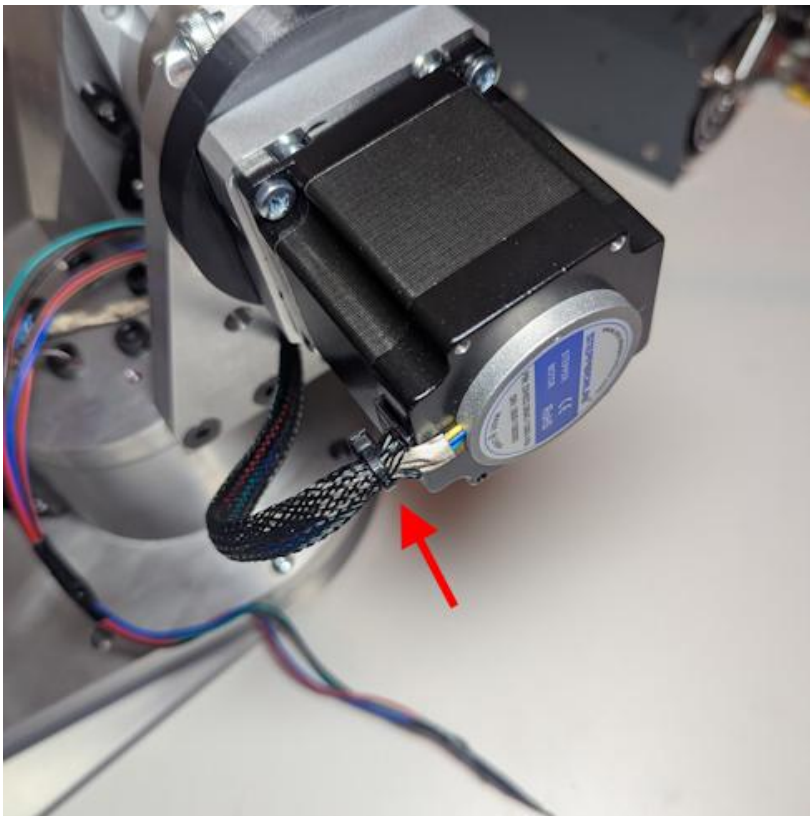

Install small cable tie around base of J2 motor – encoder wires and braided sleeve (red arrow).



If desired you can apply liquid electrical tape to base of wires and braided sleeve as shown.

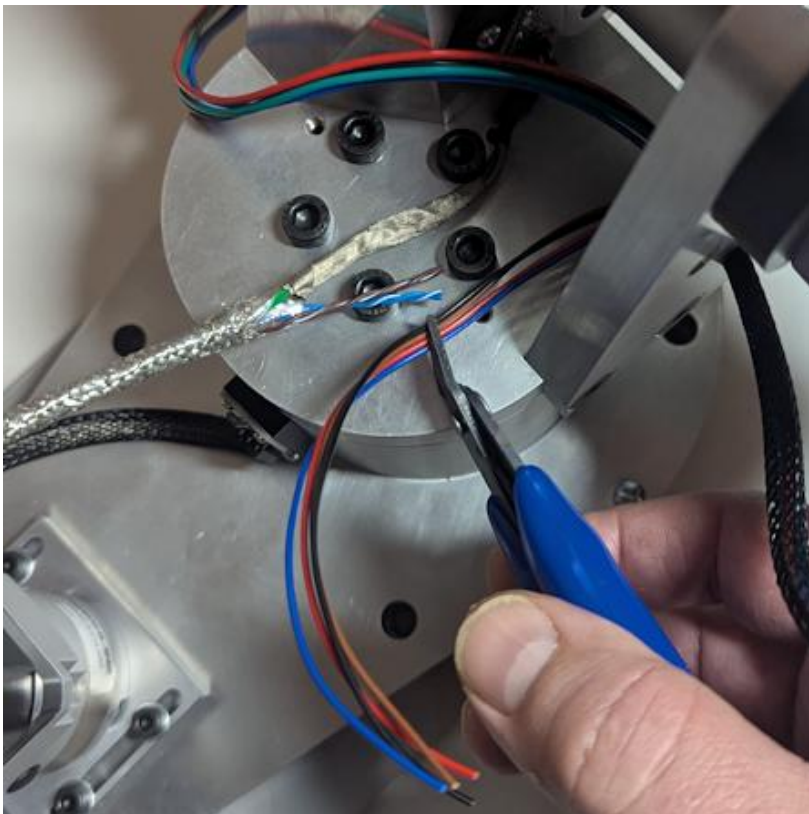

Separate the encoder wires from the motor wires, then trim the encoder wire as shown so that they align end to end with the CAT5 brown and blue pairs.

NOTE: in the next step we will be soldering the encoder wires to the brown and blue pairs.

Also save the remainder encoder wires as some of them will be used in chapters 3 and 4.

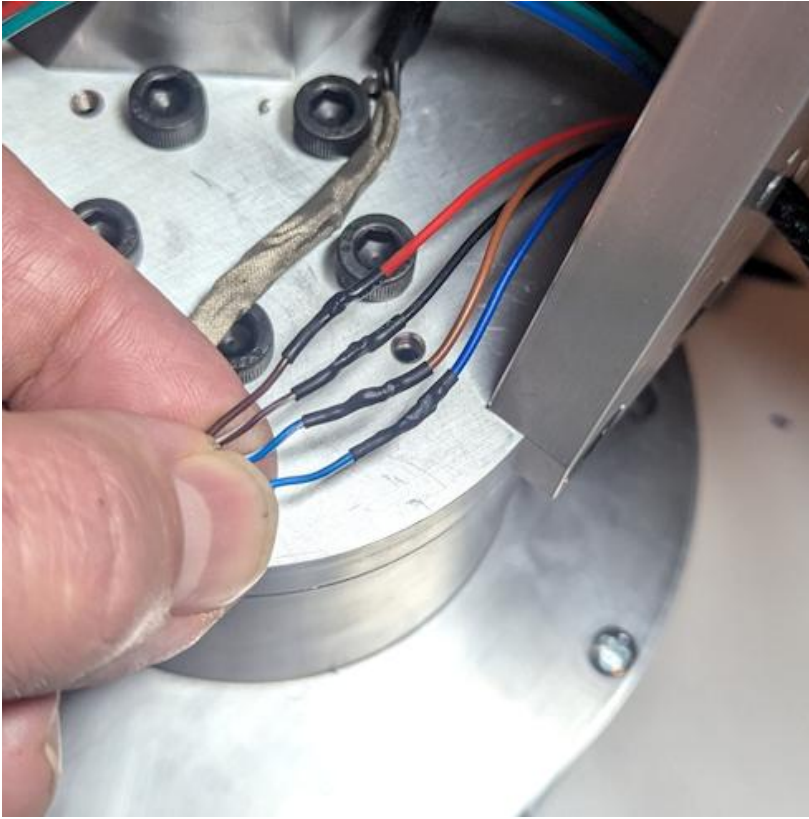

Solder and heat shrink the connection from the J2 encoder to the CAT5 cable as follows:

Encoder red wire to the cable brown wire.

Encoder black wire to the cable white – brown stripe wire.

Encoder brown wire to the cable white – blue stripe wire.

Encoder blue wire to the cable blue wire.

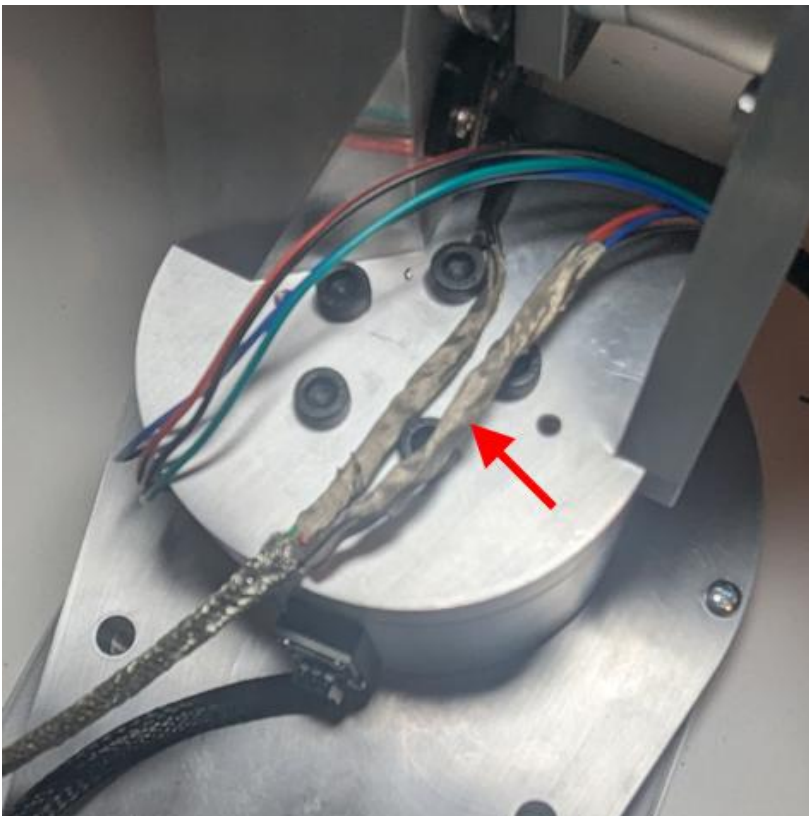

Cut length of EMI tape 7cm long and wrap encoder wires as shown.



Cut Red, Black, Blue & Green 20awg wires to a length of 34cm long.

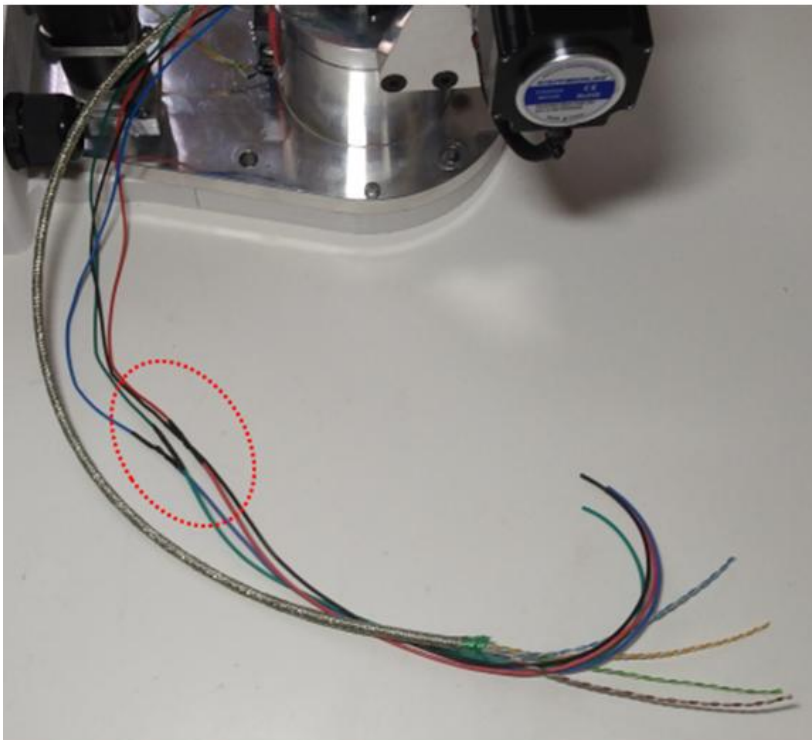

Solder and heat shrink 34cm long extension wires to the J2 motor wires as shown.

Be sure to match colors so that red goes to red and so on.

With the J2 motor wires extended the motor wires and Cat6 cable for J2 should now be the same length.





Wrap ends of J2 motor wires and the J2 Cat6 cable wires with wraps of tape and then use a marker to put (2) stripes on each so that you will know these are for J2 when wires have been routed inside enclosure.



Press (1) #30204 bearing race into the J3 bearing cup.

(See notes on bearing fit in overview section)



Secure J3 bearing cup and race to end of J2 arm using (6) M3x20 flat head screws.



Install 8mm keyed shaft with 2x2mm keystock into J3 spindle.

- 8mm shaft should be 50mm long.
- 2x2mm keystock should be 50mm long.

Secure shaft and key in position with M3x4 set screw



Install AS3552 thrust washer then AXK3552 bearing and another AS3552 washer onto J3 spindle as shown.

NOTE: don't forget to add a small amount of grease to needle bearings.



Insert J3 spindle and bearing assembly into J2 arm as shown.



While holding the J3 spindle and bearing in place insert #30204 bearing over J3 spindle shaft as shown.

(See notes on bearing fit in overview section)

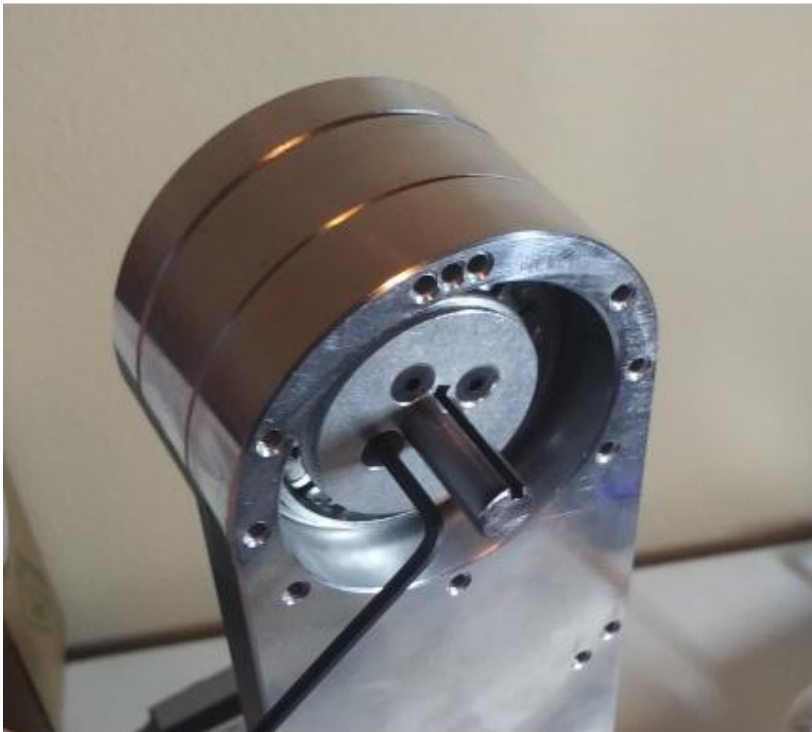

Install J3 spindle retainer and secure with (4) M3x10 flat head screws.

Tension screws so that there is no play in bearing but not too tight that the J3 shaft does not rotate smoothly.

NOTE: Rotate the spindle several times to run the bearings in and re-tension the screws as needed.



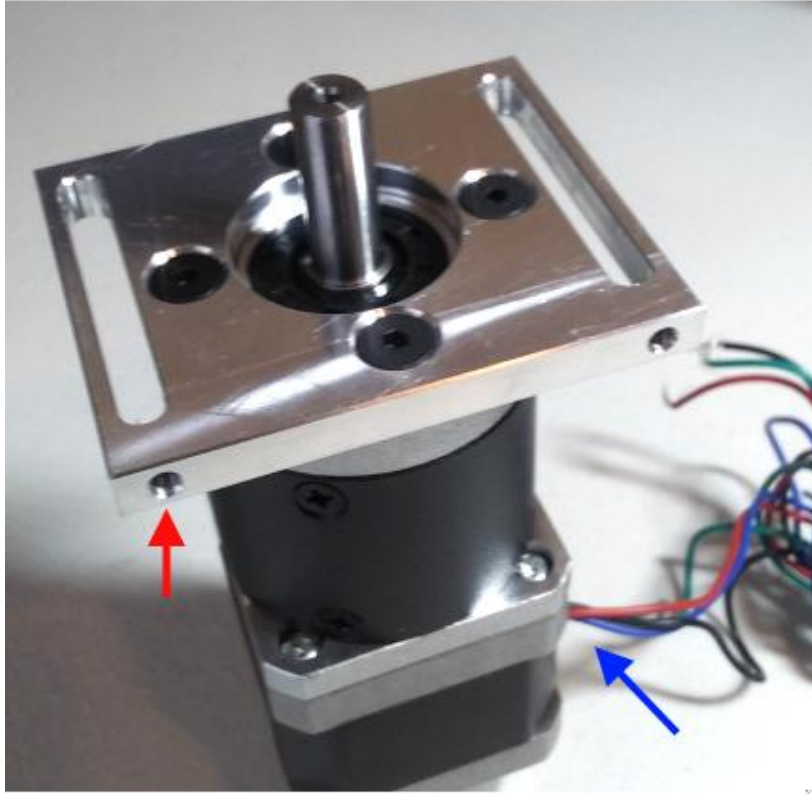

Install J3 motor mount to J3 motor SKU: 17HS15-1684D-EG50-AR4 using (4) M4x10 flat head screws.

Make sure that the tension holes (red arrows) are 90° to the motor wires (blue arrows) in the orientation shown in the photo.

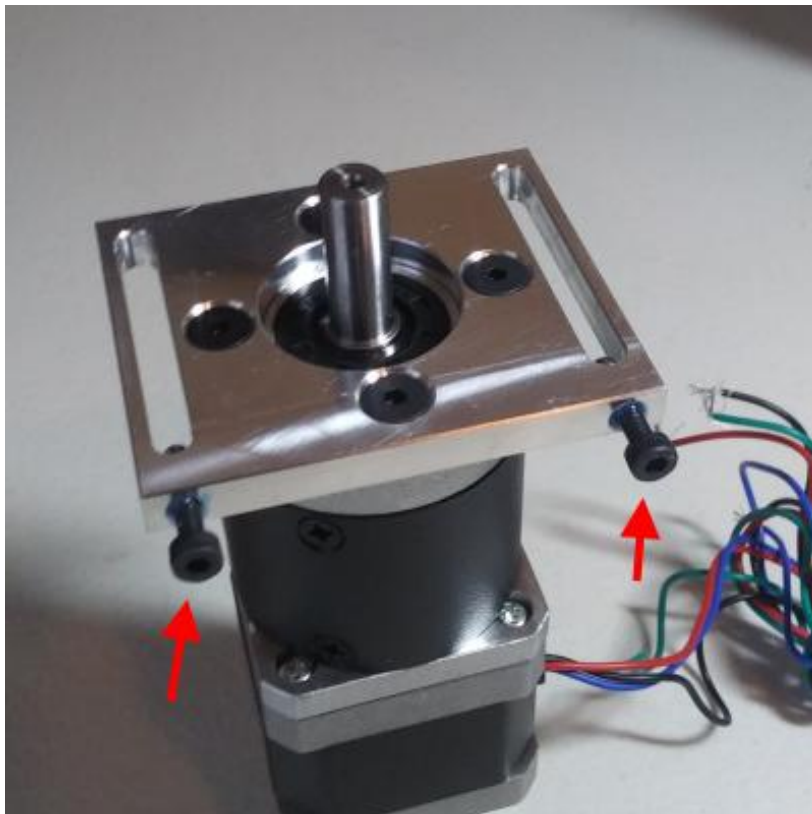

Install (2) M3x14 cap head screws into tension slot holes on J3 motor mount.



Install the Long Shoulder HTD-20 pulley on to the J3 motor shaft as shown.

Make sure the Key is installed on the motor shaft and aligned to the pulley keyway.

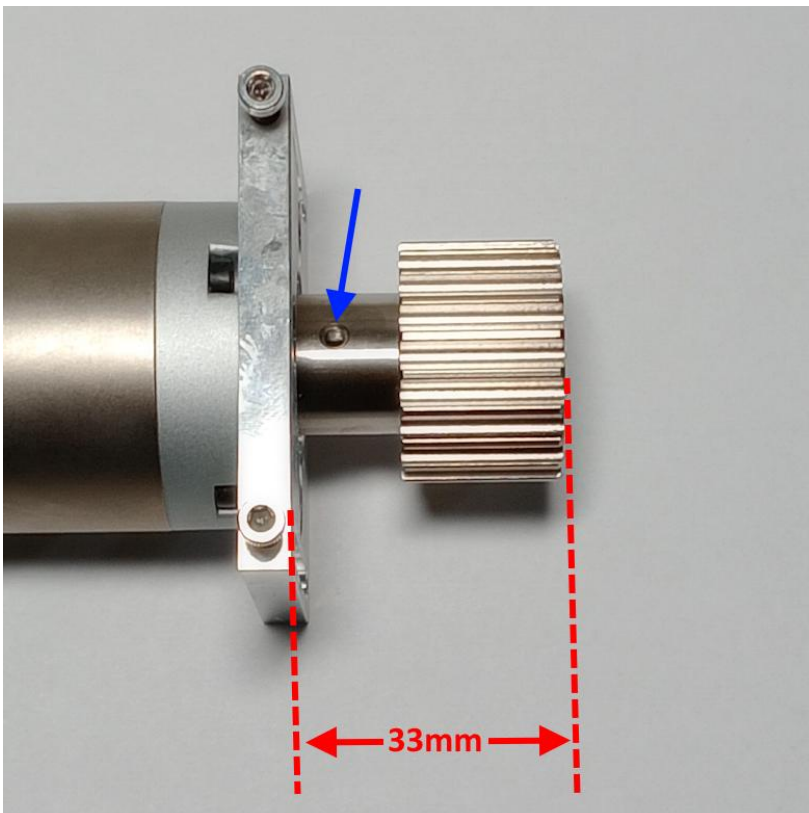

Adjust the pulley depth on the shaft so that the distance from the surface of the motor mount to the top of the pulley is 33mm as shown in the photo.

After the pulley is at the correct depth install and tighten M3x4 set screw in the pulley collar (blue arrow)

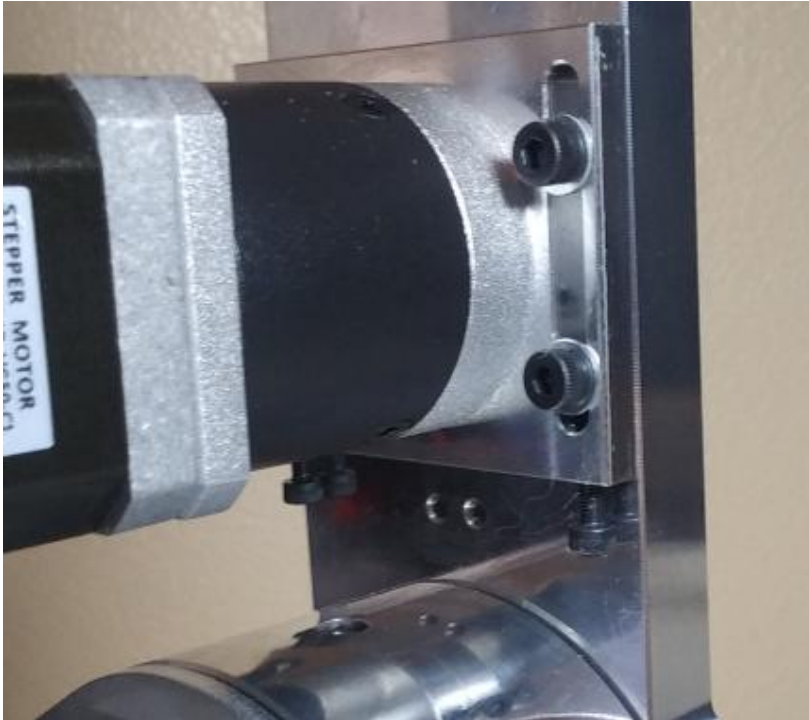

Secure J3 motor assembly to J2 arm using (4) M4x20 socket head cap screws and (4) washers.

Make sure the wire pigtail is facing to the left or toward the rear of the robot assembly.

Make sure the socket head cap screws securing the motor to the arm are slightly loose so that motor can slide to apply tension in a later step.

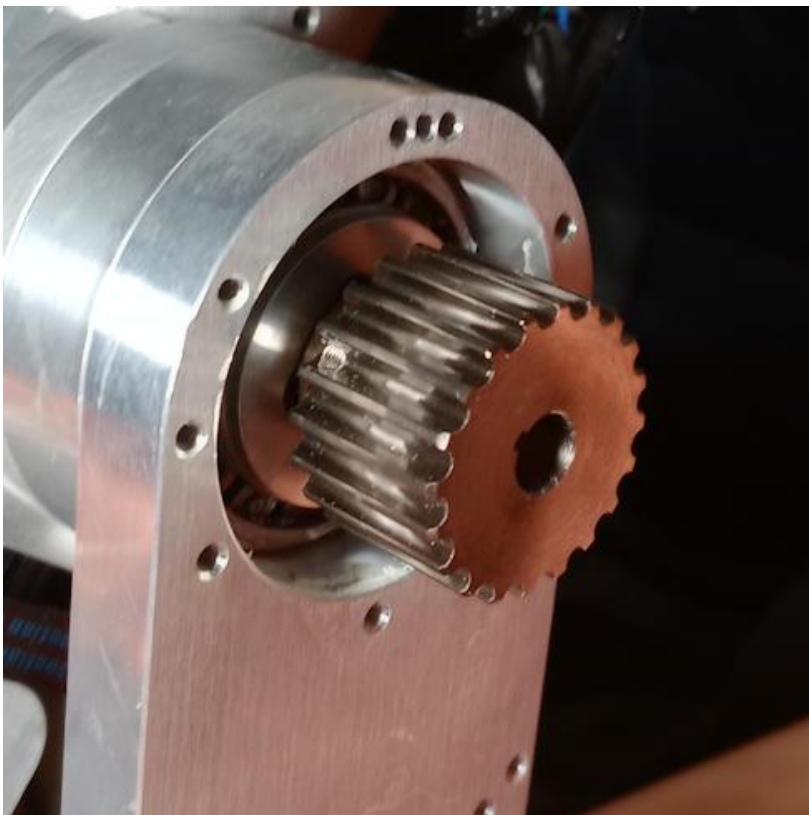

Install the short shoulder HTD-20 pulley onto the J3 8mm shaft.

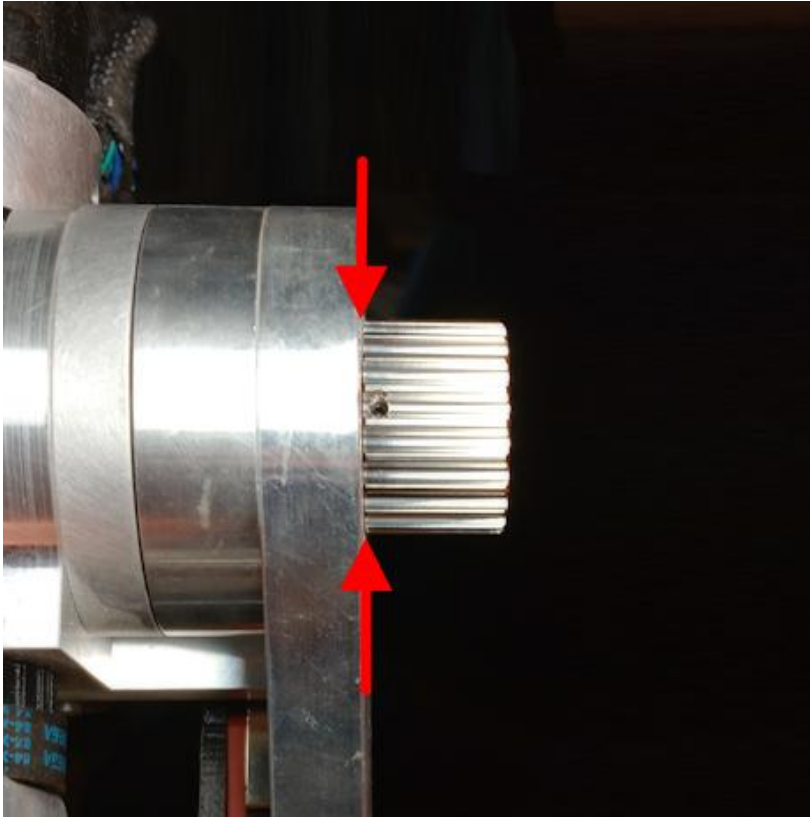

Note that the left or inside edge of pulley should be flush with J2 plate as indicated by the red arrows.

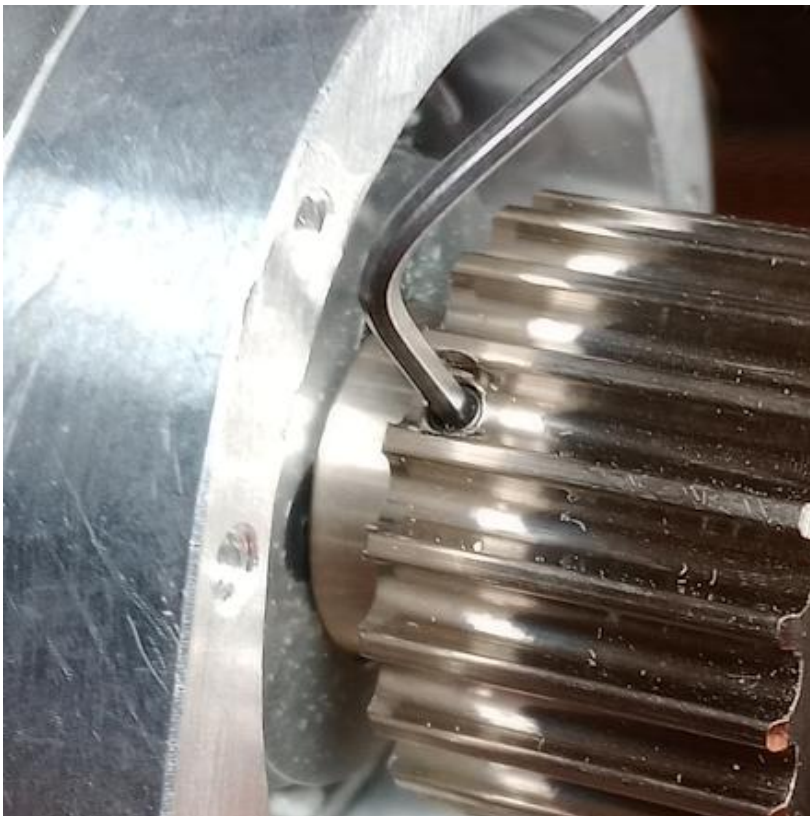

Install and tighten M3x3 set screw in threaded hole on side of pulley as shown.



- ▶ Install HTD-550M belt over both HTD-20 pulleys as shown.



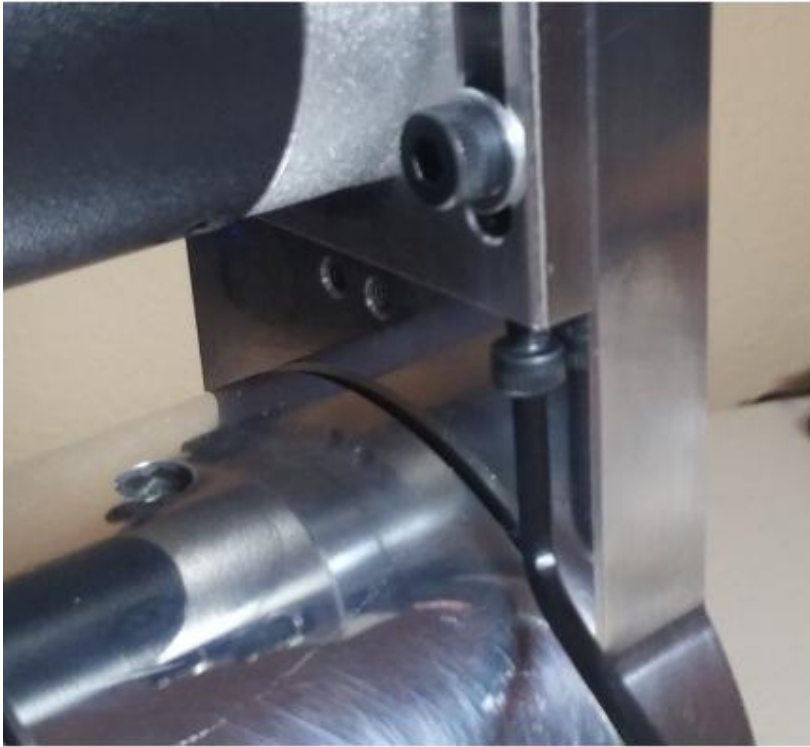

Tighten M3 tension screws until there is moderate tension on the belt.

After belt is tensioned, finish securing the J3 motor mount by tightening the (4) M4x20 motor mount screws.

This video shows the expected deflection or tension for joint 3. [Joint 3 Video](#)

Belt Tension: Tighten the belt until all slack is removed and there is no detectable backlash when reversing direction by hand. The belt should feel firm and taut—not loose or floppy. A slightly tighter belt is generally preferable to one with measurable play, but avoid excessive tension.



For joint 3 cut length of continuous flex Cat6 cable to a length of 120cm long and remove outer jacket. (see overview section on jacket removal)



Remove 15cm of shielding from one end of the cable and remove 28cm of shielding from the other end. **(see overview section on removing shielding – be very careful not to cut or damage wires)**

Save 28cm length of shielding for future step.

The end with 15cm of shielding removed will be the end of the cable that is routed to the base enclosure.

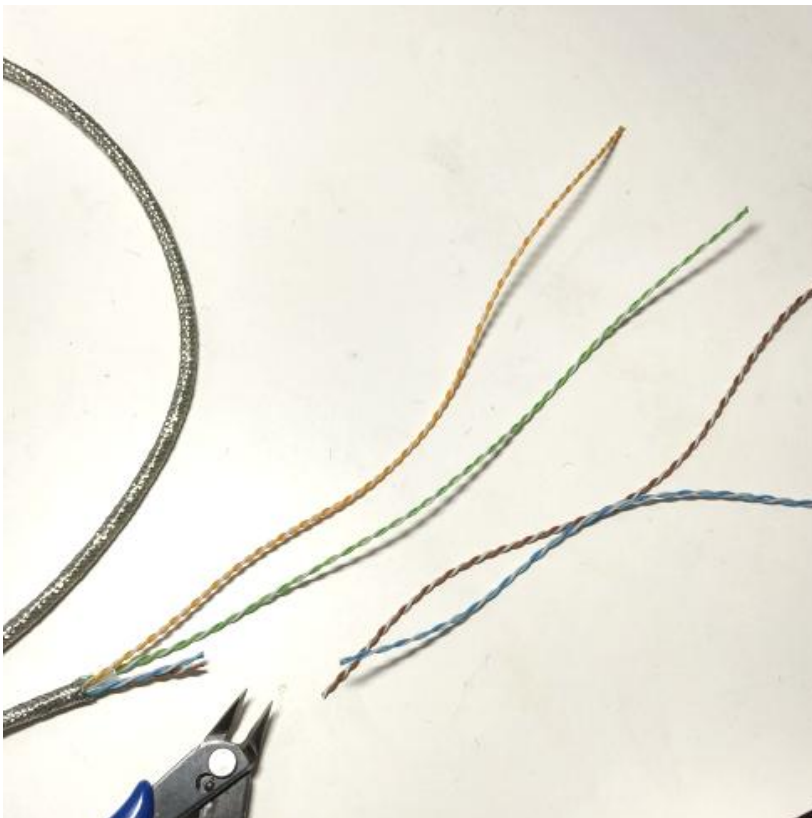

From the end of cable that has 28cm of shielding removed - cut and remove 25cm of the brown and blue twisted pairs leaving 3cm of wire exposed.

Insert the orange and green twisted pairs into the 28cm length of shielding removed earlier.

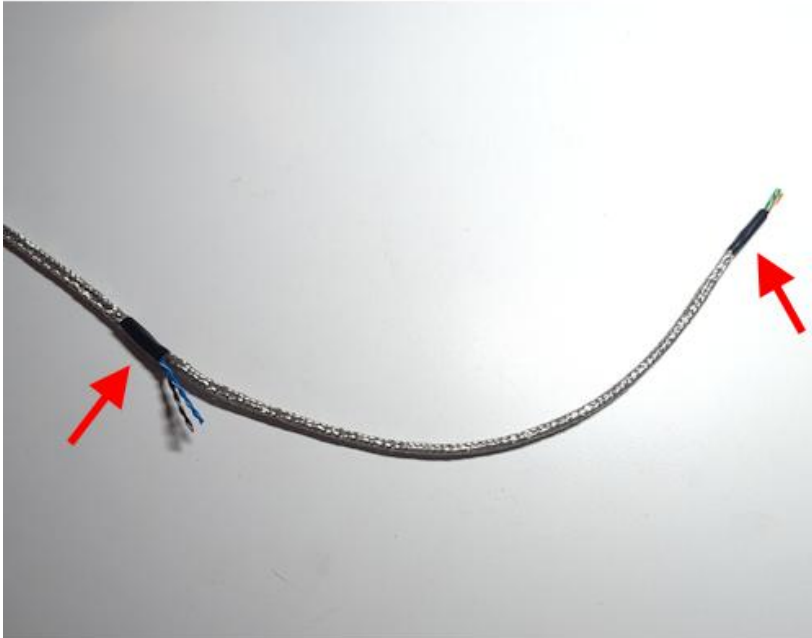

Then wrap each end of shielding with tape as indicated by the red arrows.

Make sure to leave 1.5cm to 2cm of the orange and green twisted pair exposed.

Cut length of ¼" braided sleeve to a length of 23cm long then route green and orange twisted pairs through sleeve as shown.



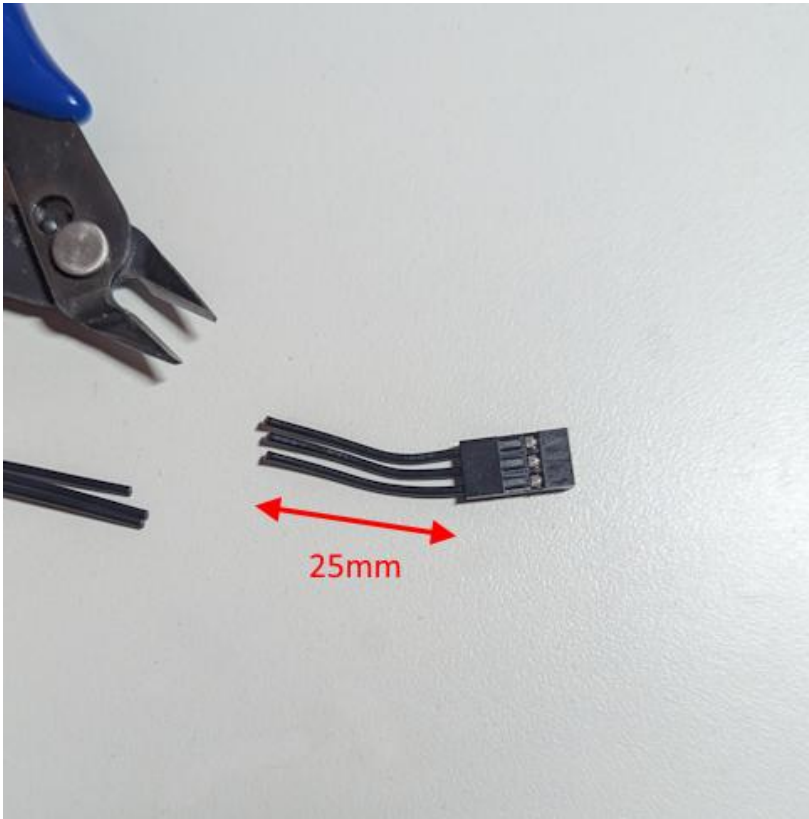

Trim wires on 2.54 mm female 3 pin connector lead leaving 25mm wire length.

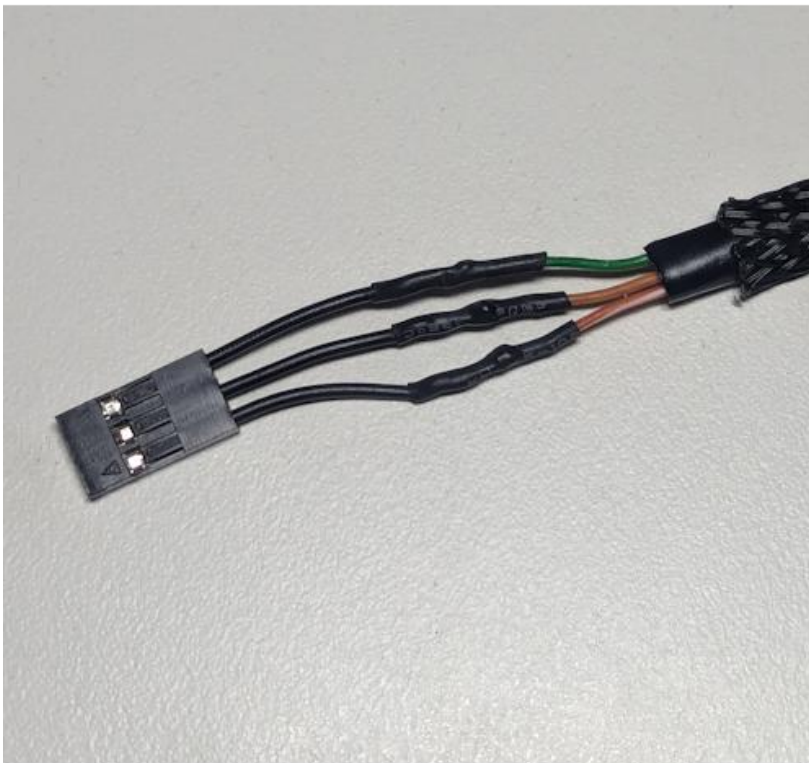

Solder and heat shrink the wires from the 2.54mm Dupont 3 pin connector to the orange and green wires on the short end of the shielded CAT5 cable that has 4cm of shielding removed.

- Solder the green wire to the wire coming from the right terminal.
- Solder the solid orange wire to the wire coming from the center terminal.
- Solder the orange white stripe wire to the wire coming from the left terminal.



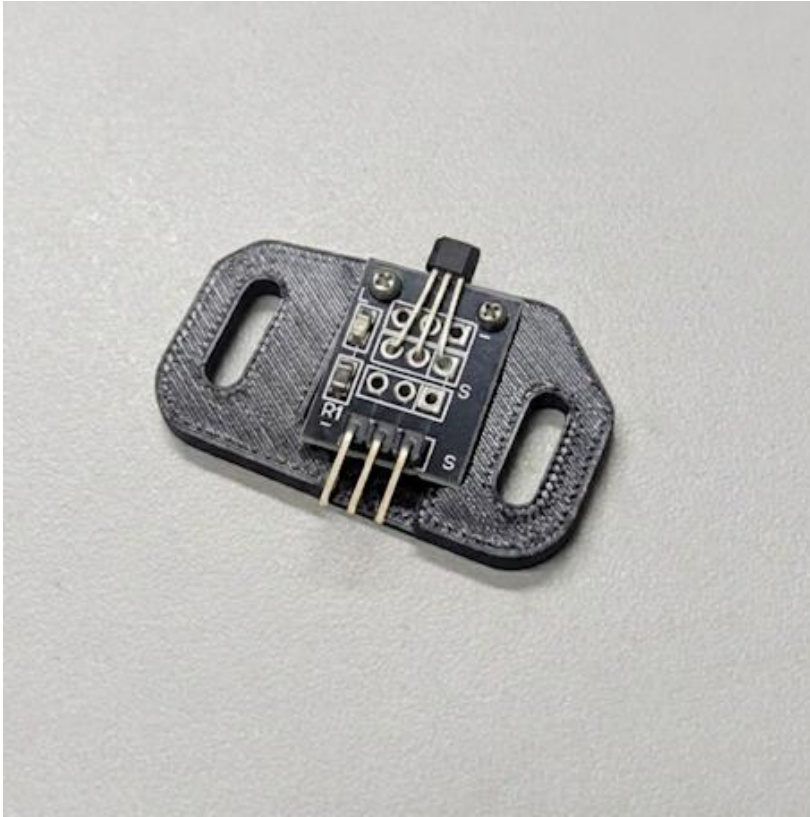

Secure 3144 hall effect sensor to 3D printed J3 sensor mount using (2) M1.6x4mm screws.

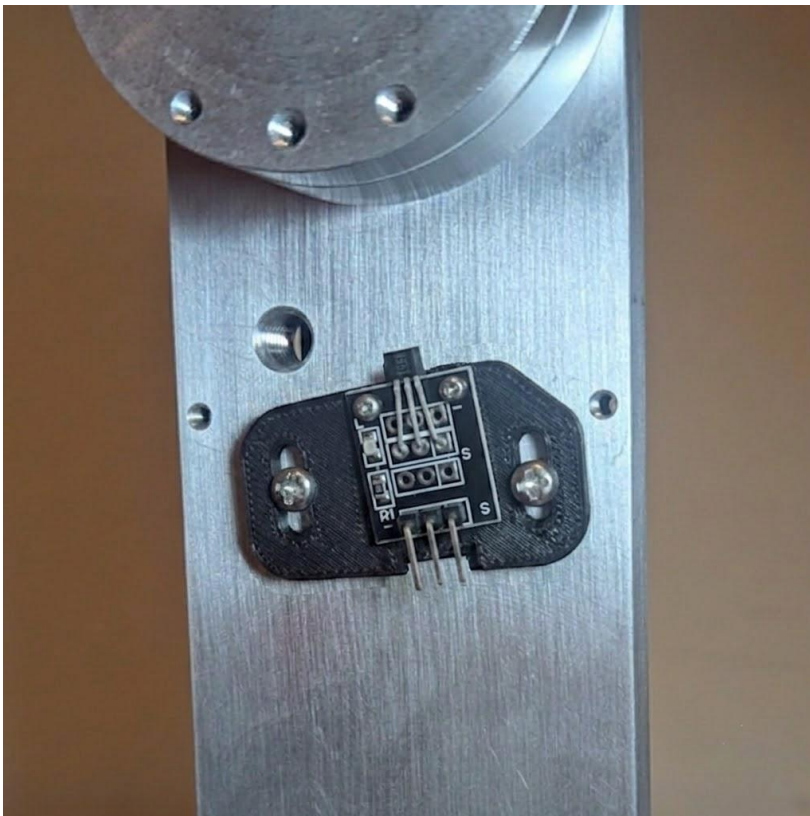

Secure the hall effect sensor and mount to the J2 Turret Housing as shown using (2) M3x10 pan head screws.

NOTE: when it comes time to commission the robot and test the autocalibration for joint 3 you may need to adjust the sensor mount position as needed and bend the sensor head leads as needed to ensure the sensor triggers reliably every time.

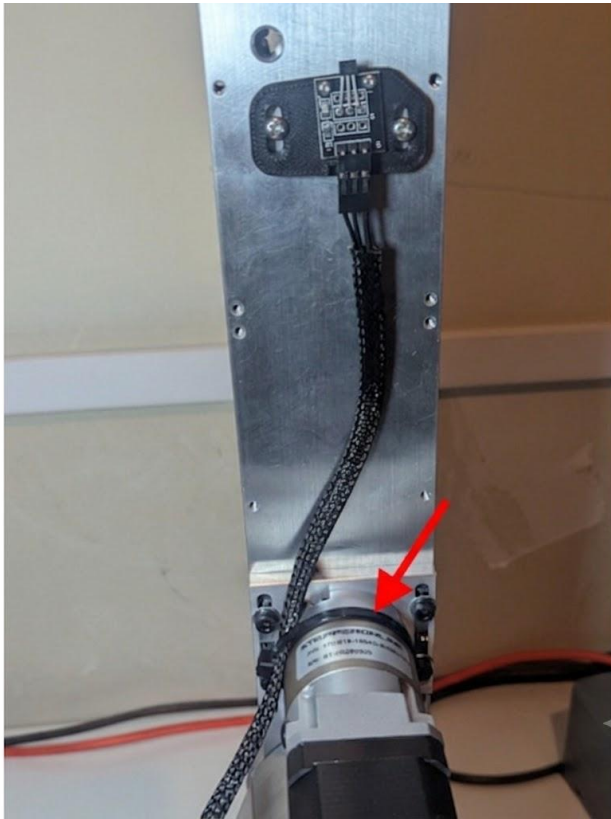

Connect the Dupont 3 pin connector from the J3 CAT5 cable to the hall effect sensor.

Use large cable tie to secure the cable to the J3 gearbox as shown. (red arrow)



Trim the white, yellow, orange and green encoder wires on the J3 motor as shown (these wires are not used).

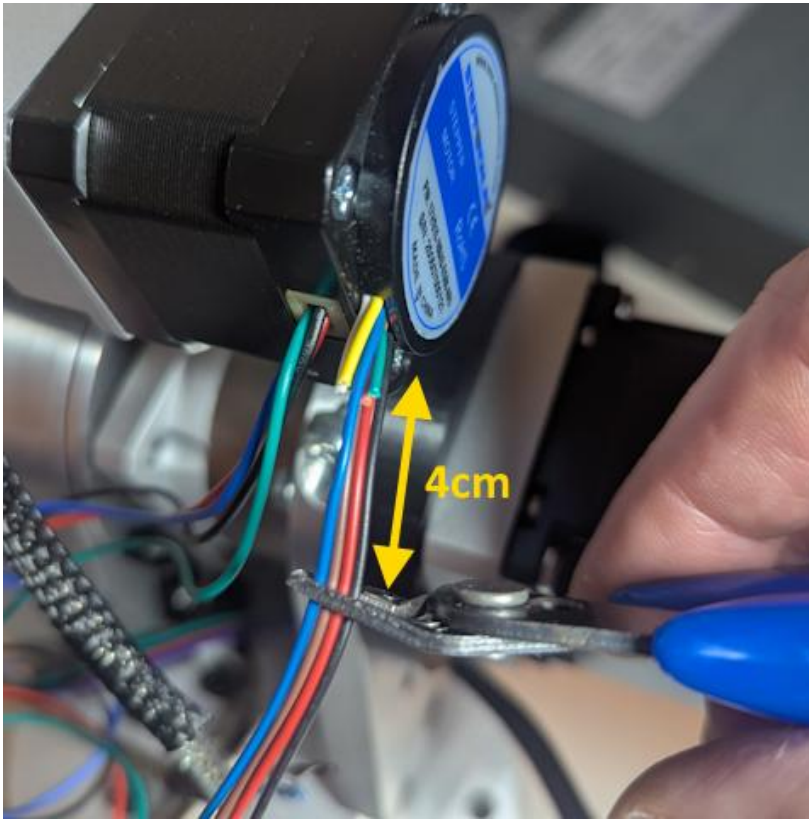

Trim the blue, brown, red and black wires from the J3 encoder as shown.

These wires should be trimmed to 4cm in length.

Make sure you have separated the motor wires and are not cutting the motor wires – make sure you have the encoder wires.



Solder and heat shrink the connection from the J3 encoder to the Cat6 cable as follows:

Encoder red wire to the cable brown wire.

Encoder black wire to the cable white – brown stripe wire.

Encoder brown wire to the cable white – blue stripe wire.

Encoder blue wire to the cable blue wire.

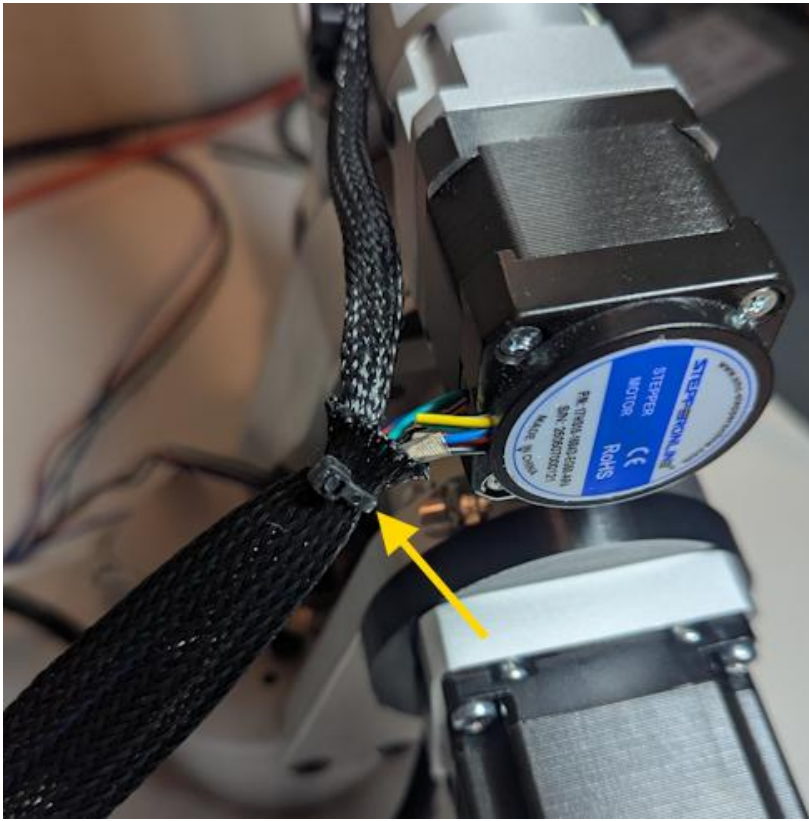

Cut length of 3/4" braided sleeve to a length of 35cm long then route J3 motor wires and J3 Cat6 cable through sleeve as shown.

Secure end of sleeve with cable tie (yellow arrow).

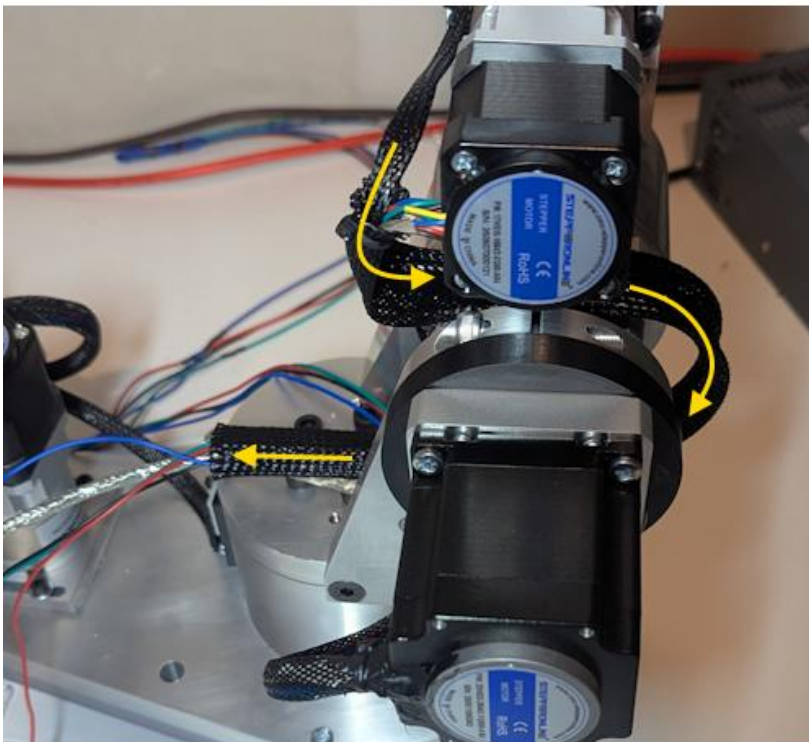

Route the J3 CAT5 cable for J3 under the J3 gearbox, then around and under the J2 gearbox so that the J3 cable joins where the J2 wires come out above the J1 Turret.



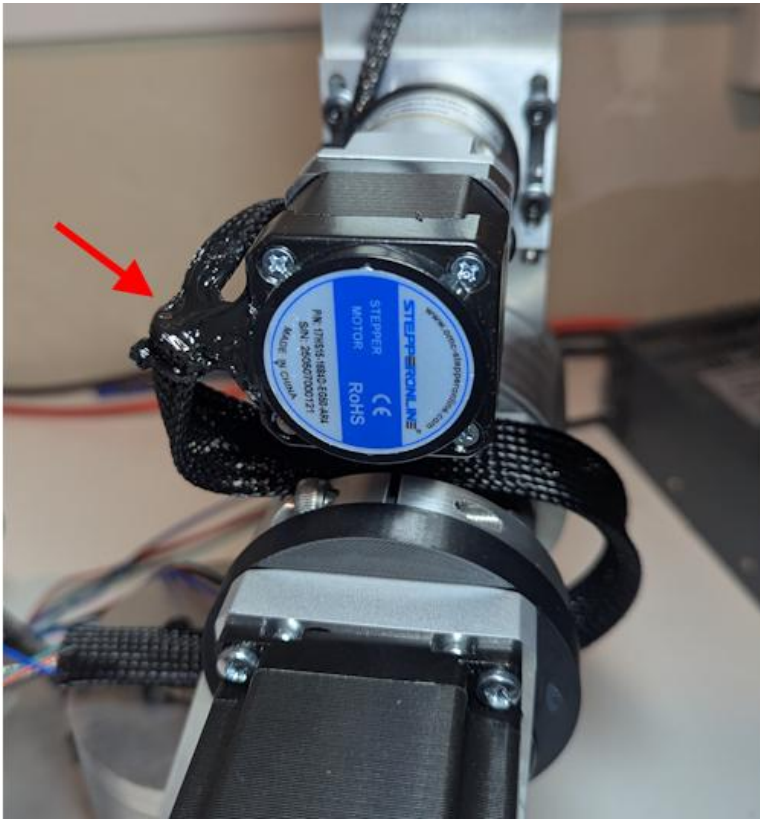

If desired you can apply liquid electrical tape to the base of the J3 wires where the sensor wires join the motor and encoder wires.

This will strengthen the wire and cable joints and creates a cleaner looking junction point.



Cut Red, Black, Blue & Green 20awg wires to a length of 50cm long.

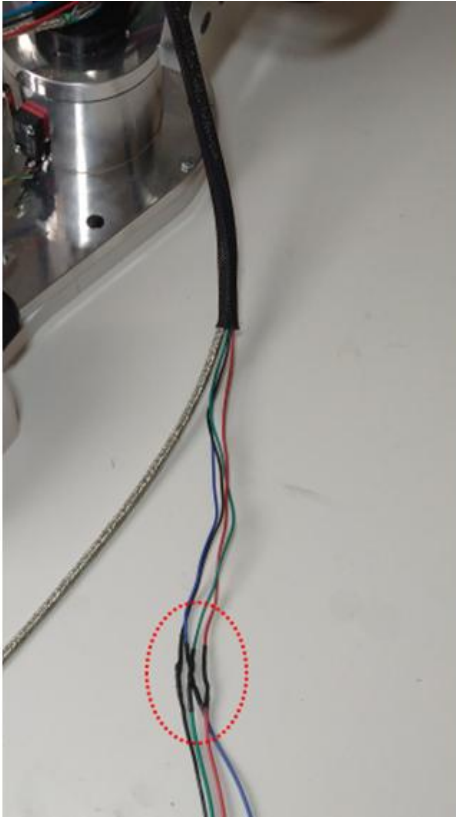

Solder and heat shrink 50cm long extension wires to the J3 motor wires as shown.

Be sure to match colors so that red goes to red and so on.

With the J3 motor wires extended the motor wires and Cat6 cable for J3 should now be the same length.

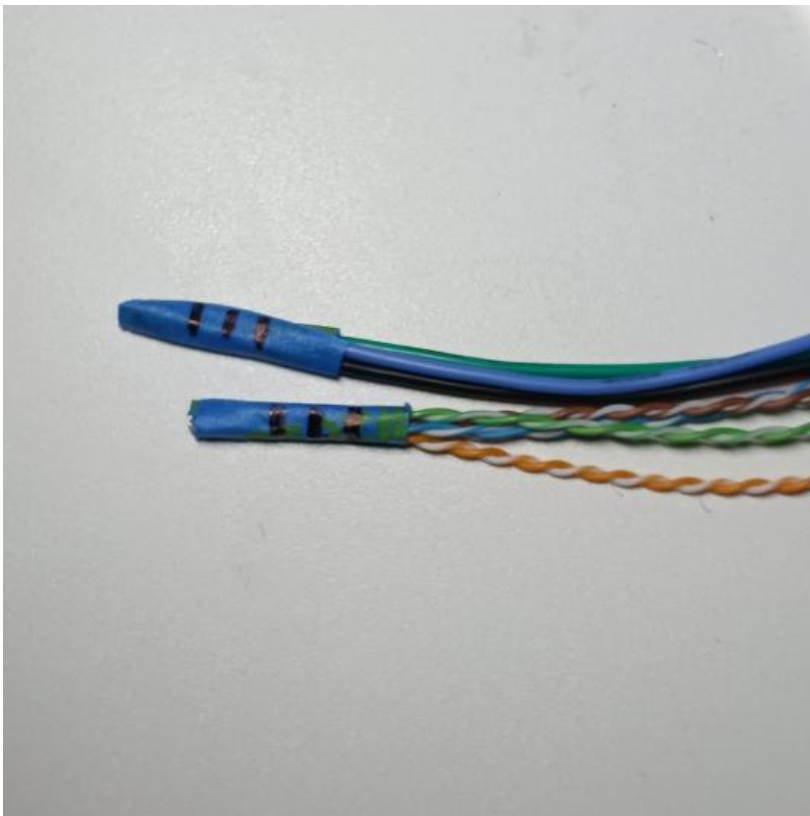

Wrap ends of J3 motor wires and J3 Cat6 cable with tape and then use a marker to put (3) stripes on each taped end so that you will know these are for J3 when wires have been routed inside enclosure.

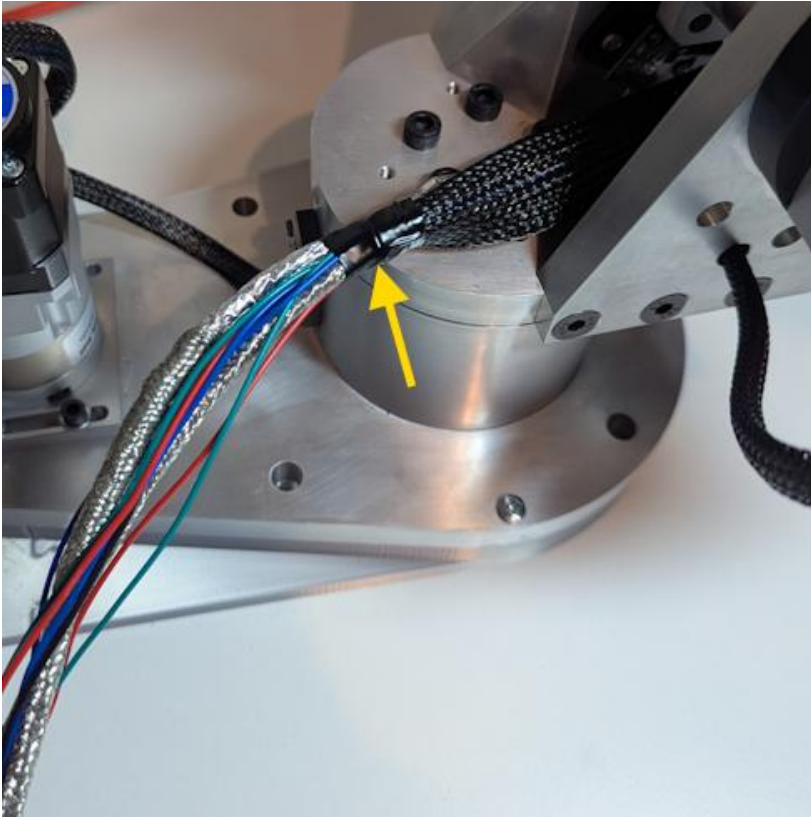

Wrap the J2 and J3 wire harnesses as shown at the base of the J3 braided sleeve with a single wrap of electrical tape (yellow arrow).

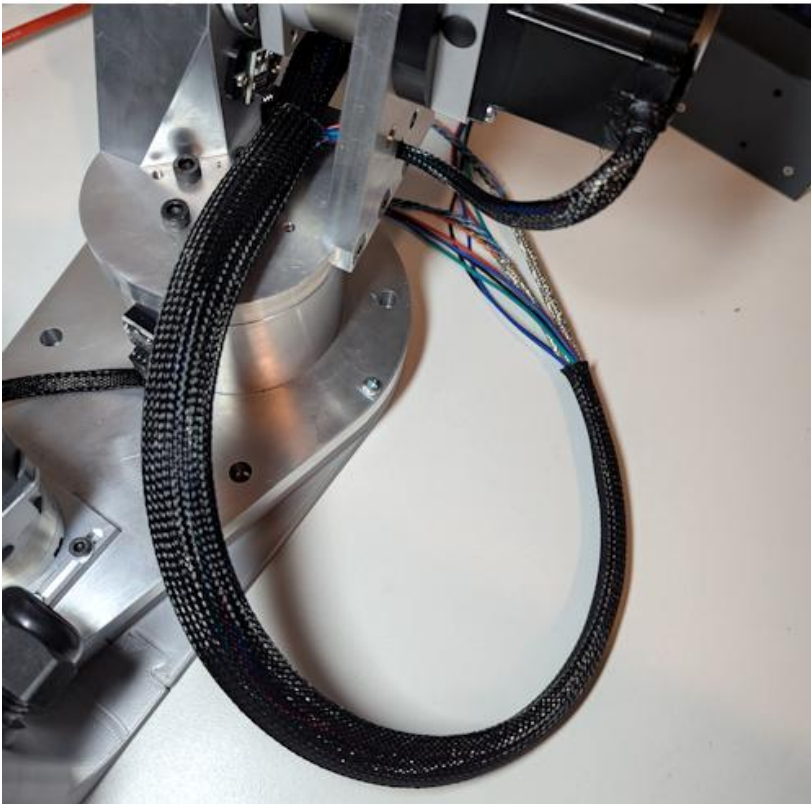

Cut length of 3/4" braided sleeve to a length of 52cm long then route all of the J2 and J3 wires and cables through sleeve.





Insert (2) large cable ties through the 3D printed J2 Cable Holder as shown in photo.

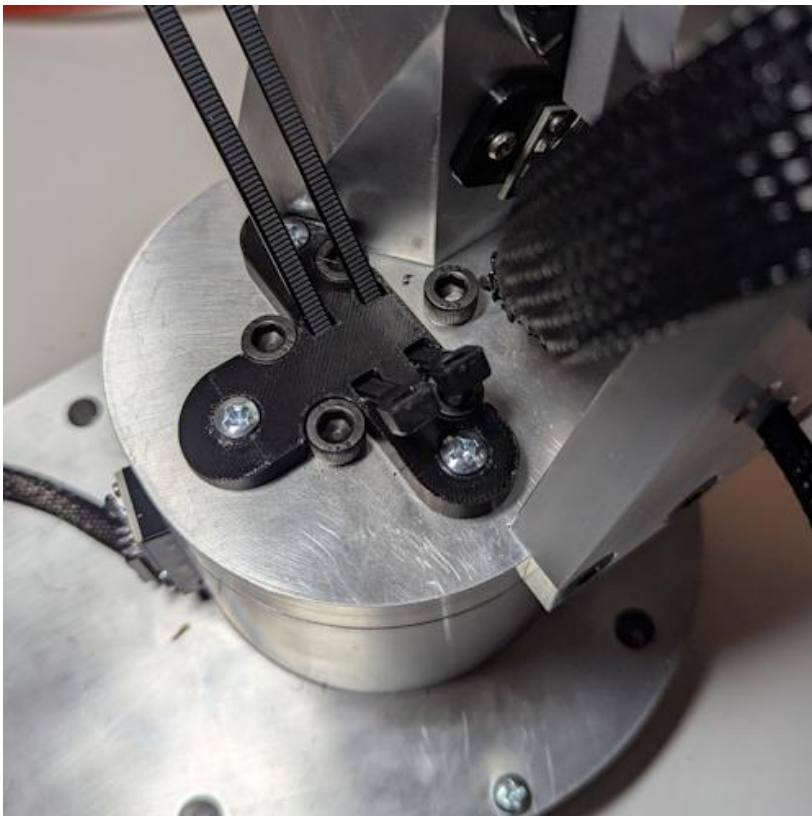

Place J2 and J3 cables up out of the way.

Secure J2 Cable holder to the J1 Platform as shown with (2) M4x8 pan head screws.

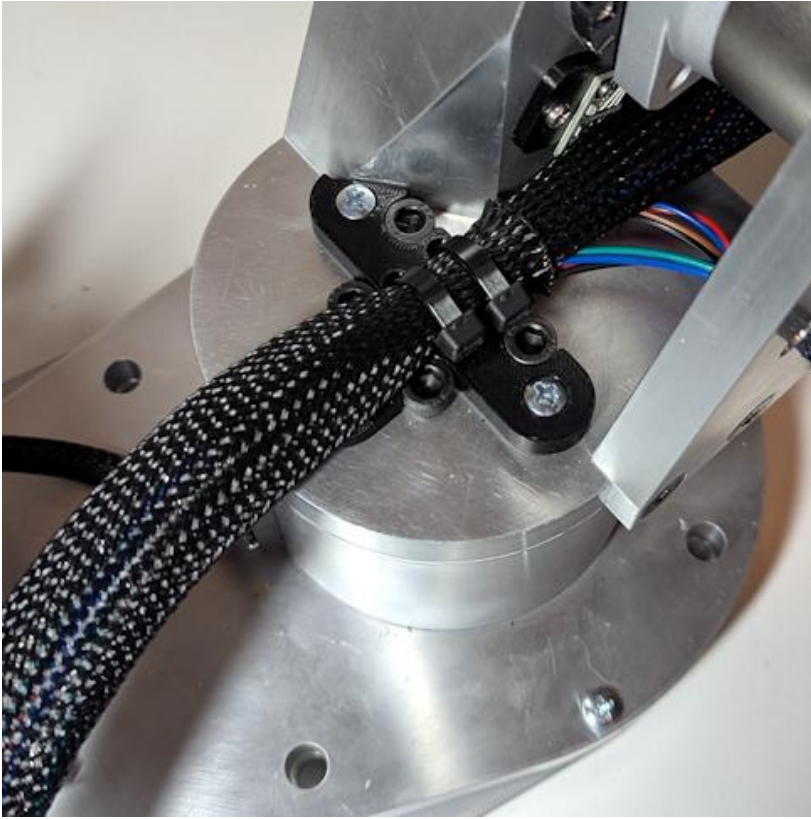

Lay the J2 and J3 cables down center of J2 Cable Holder. Secure the cable bundle with the (2) cable ties as shown and then trim the cable die ends.

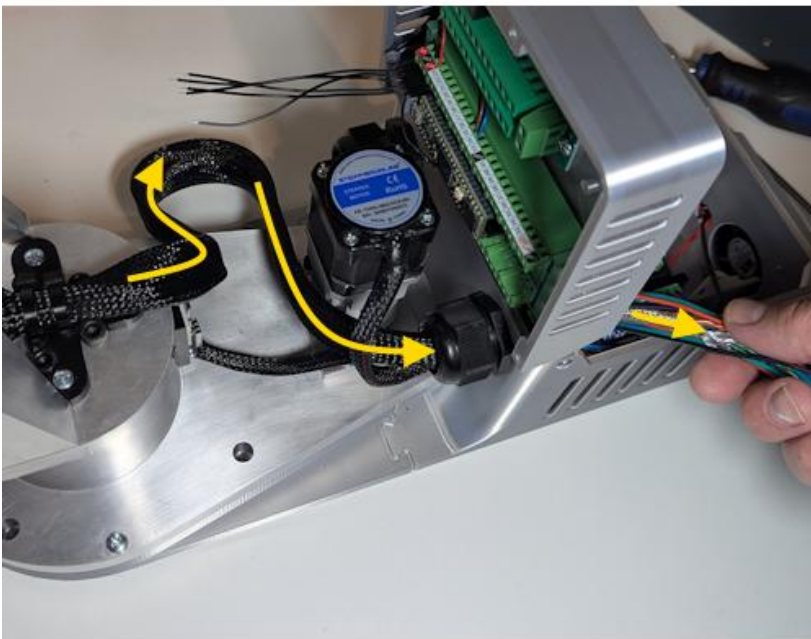

Route the J2 / J3 wire loom along with the J1 wires into the left enclosure gland nut as shown (yellow arrow).



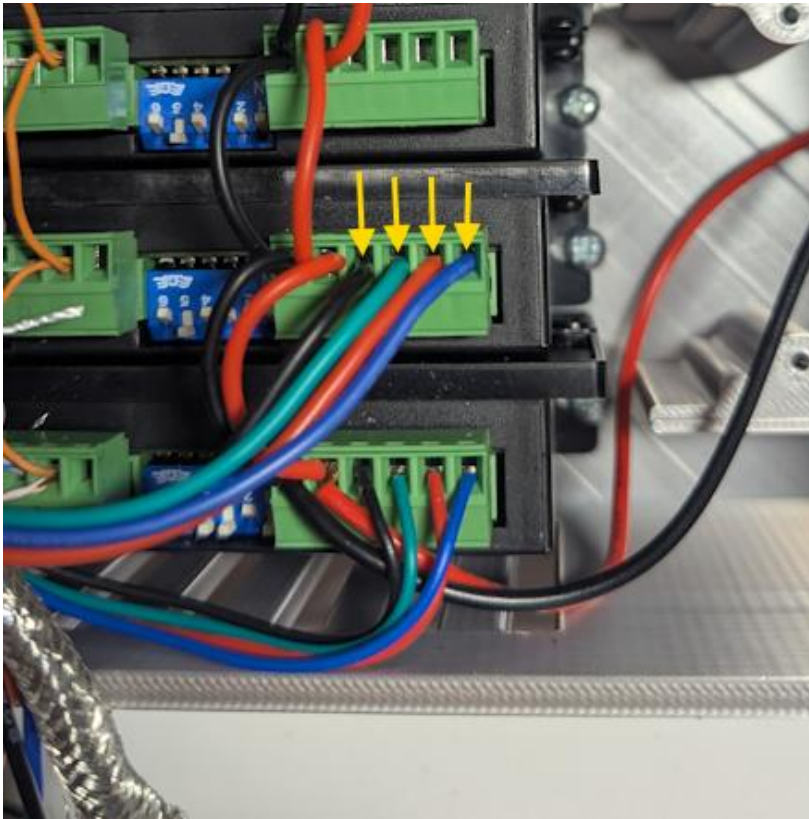

Lift the enclosure tray up and then locate the motor wires that were taped with 2 marks for J2 then route and cut the wires as shown so that they are the appropriate length to reach the J2 driver terminals.

Connect the (4) J2 motor wires to the J2 driver terminals as follows:

A+ BLACK

A- GREEN

B+ RED

B- BLUE

NOTE: also see schematics chapter for wiring diagram

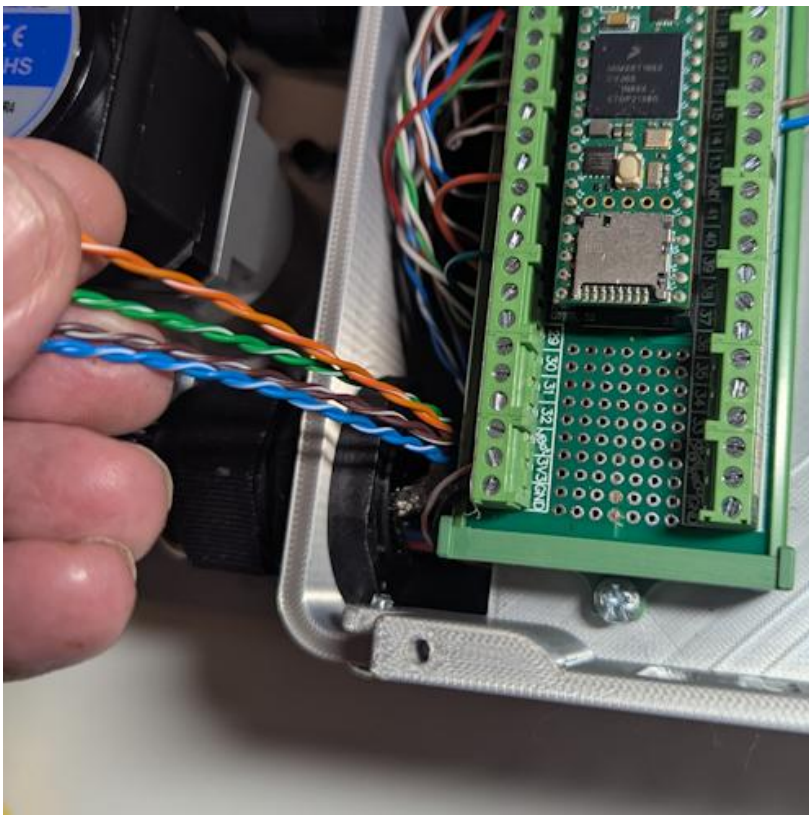

Locate the encoder and hall effect sensor CAT5 cables that were taped with 2 marked for J2 then route the wires as shown to come out above enclosure tray.

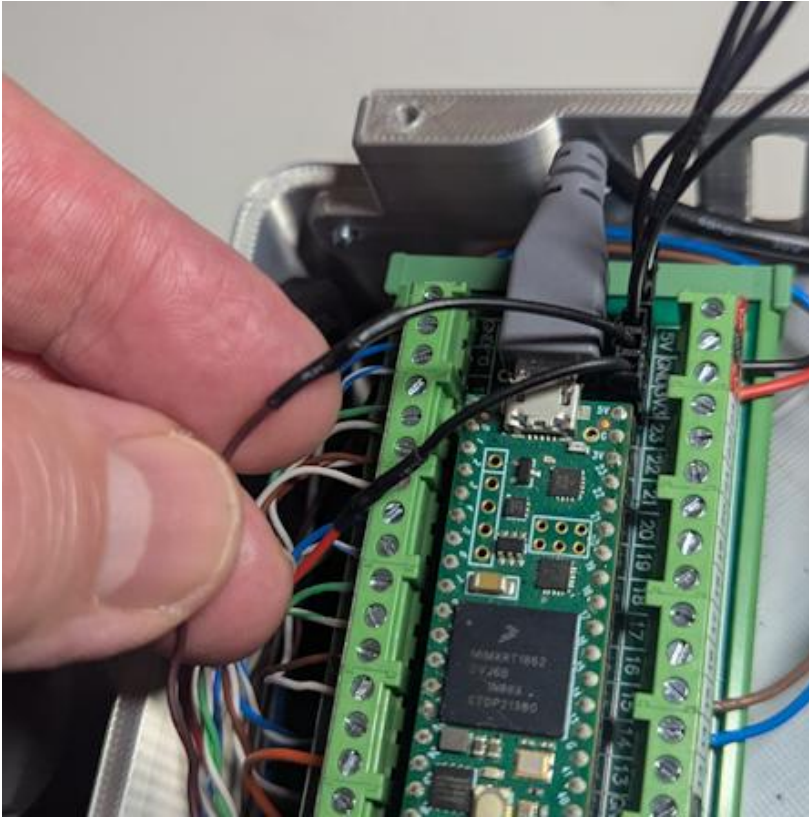

Un-twist the brown wire pair. Trim solid brown wire to length as shown in photo and solder - heat shrink the brown wire from the J2 encoder to the second wire on the Dupont 2.54mm 5v lead.

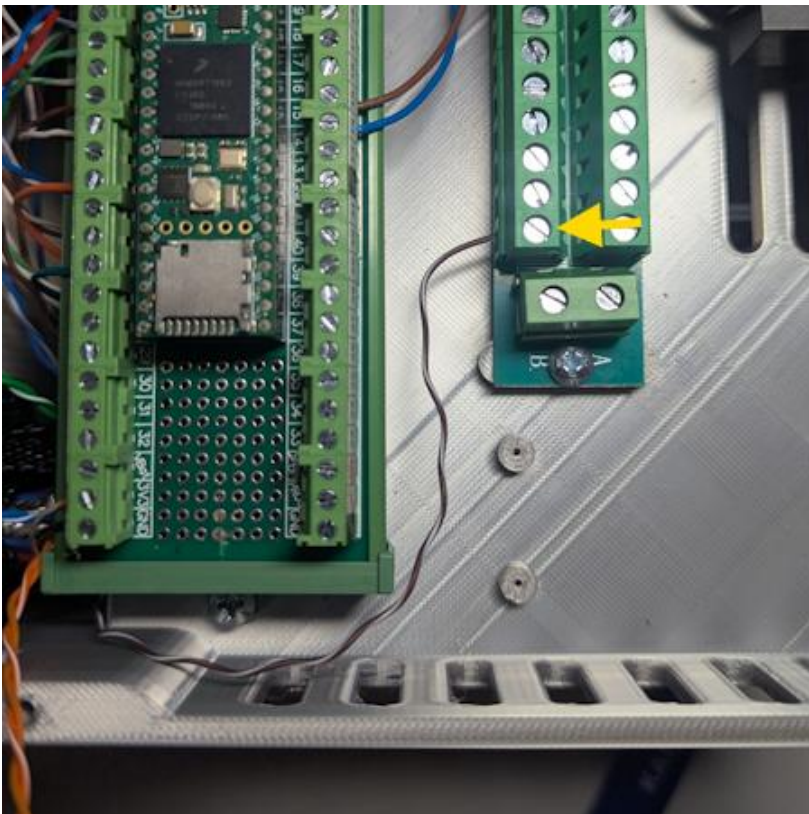

Route the brown/stripe wire over to the 2x12 terminal block and connect the wire to the 12th terminal (last) as shown.

This is the GND wire from the J2 encoder. **Use Multimeter to verify** the terminal you connected to has continuity to the “B” or GND terminal on the terminal board.

NOTE: the “A” and “B” terminals ***alternate*** across the top and bottom terminal rows – the top are ***not*** all connected to “A” and the bottom are ***not*** all connected to “B”.

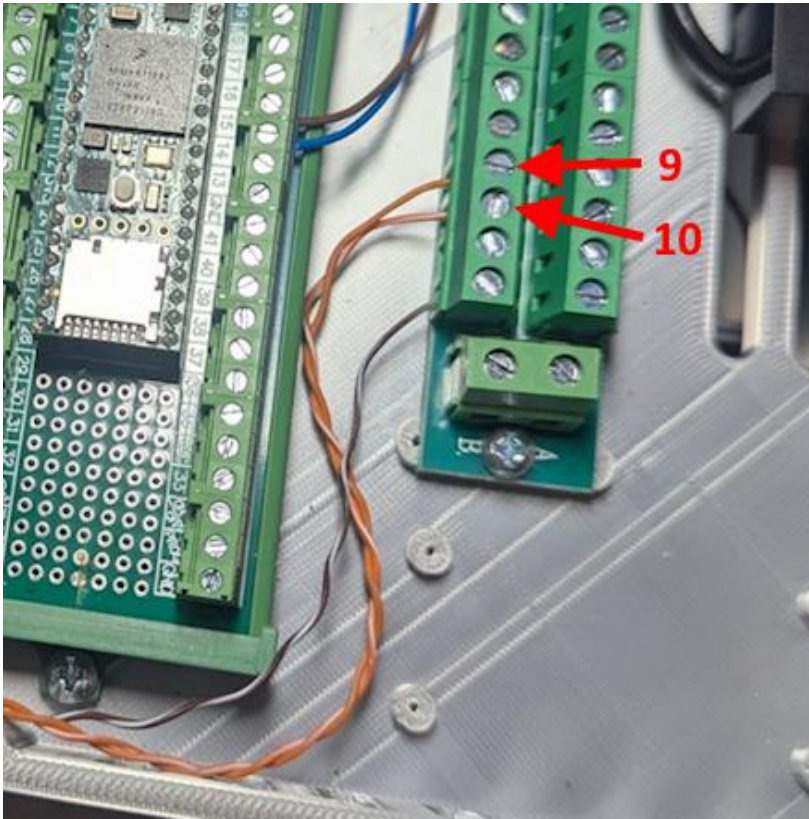

Route the orange pair over to the 2x12 terminal block and connect the solid orange wire to the 9th terminal & the stripe wire to the 10th terminal.

Use Multimeter to verify the solid orange wire has continuity to the “A” or +3.3v terminal and that the stripe wire has continuity to the “B” or GND terminal at end of terminal board.

NOTE: the “A” and “B” terminals **alternate** across the top and bottom terminal rows – the top are **not all** connected to “A” and the bottom are **not all** connected to “B”.

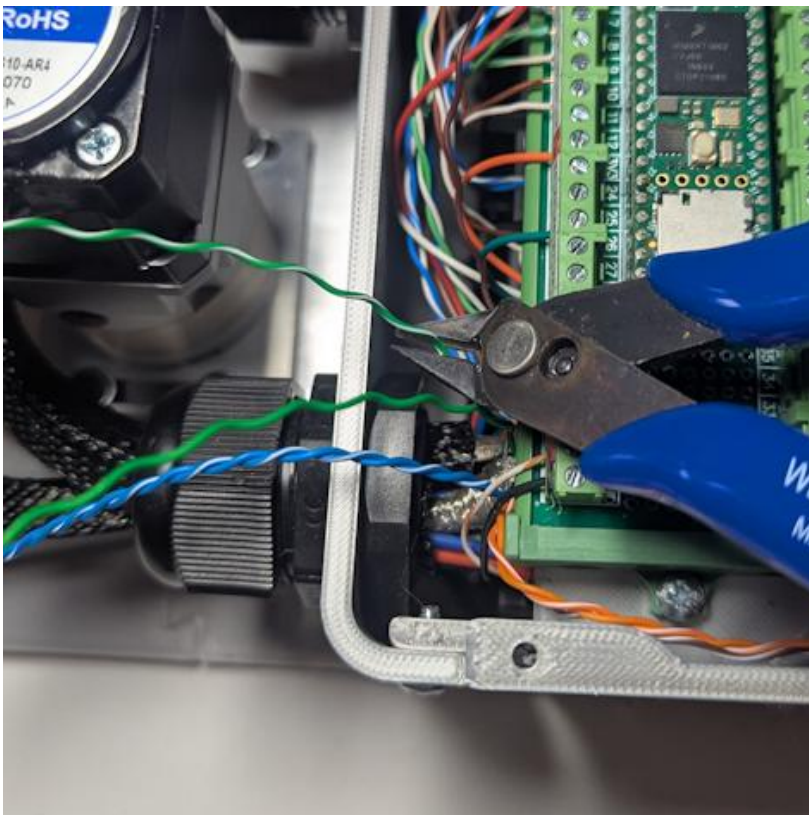

Un-twist the green wires and trim the stripe wire as shown as it will not be used.

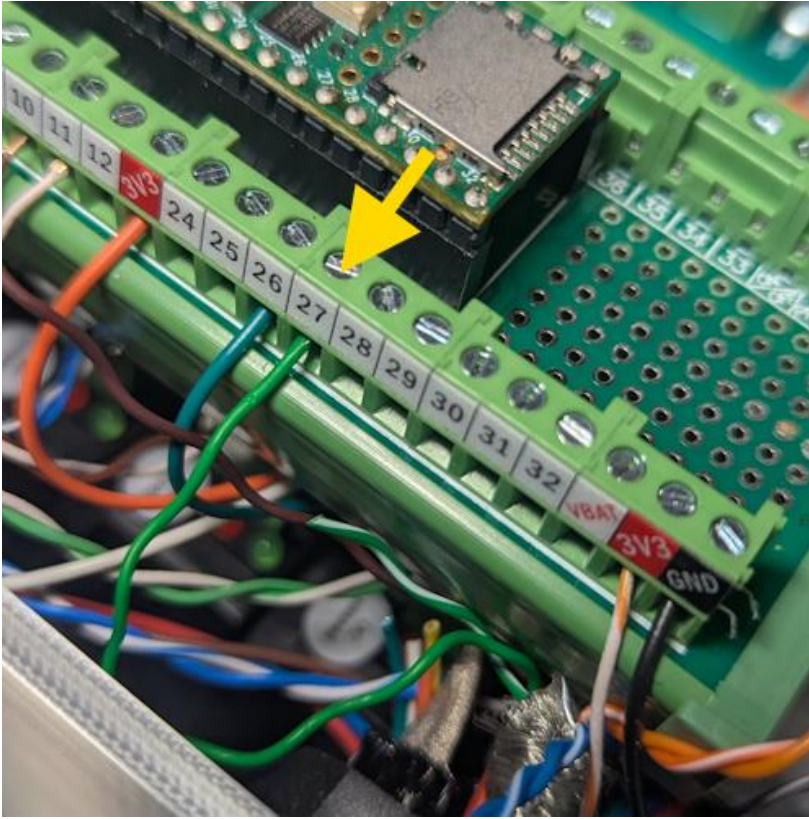

Route and trim the solid green wire to terminal 27 and connect as shown.



Route and trim the blue twisted pair over to terminals 16 and 17.

Connect the solid blue wire to terminal 16

Connect the stripe wire to terminal 17.

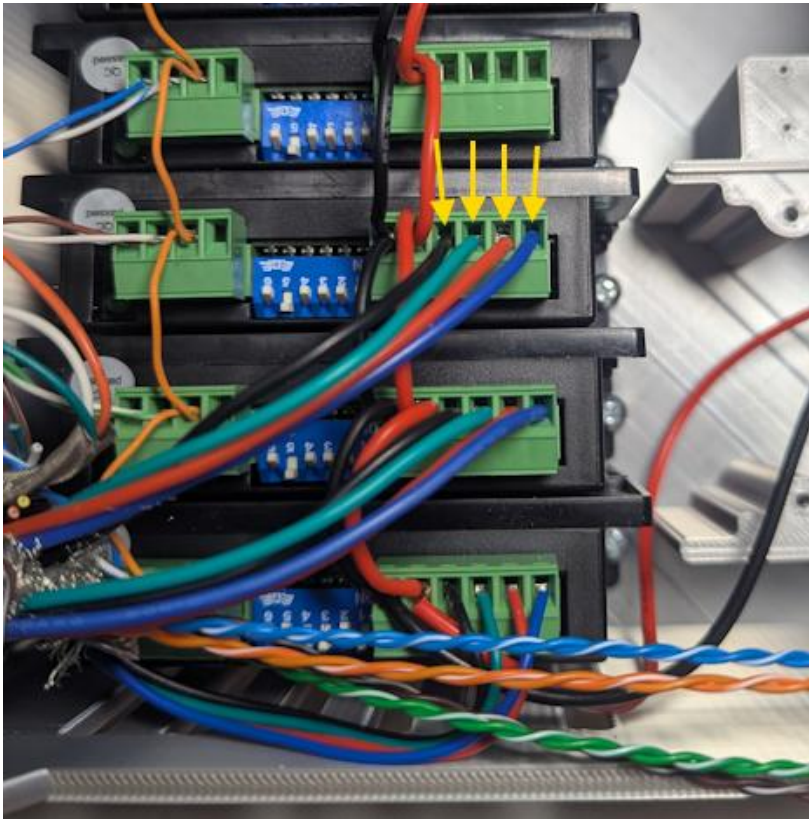

Lift the enclosure tray up and then locate the motor wires that were taped with 3 marks for J3 then route and cut the wires as shown so that they are the appropriate length to reach the J3 driver terminals.

Connect the (4) J3 motor wires to the J3 driver terminals as follows:

A+ BLACK

A- GREEN

B+ RED

B- BLUE

NOTE: also see schematics chapter for wiring diagram

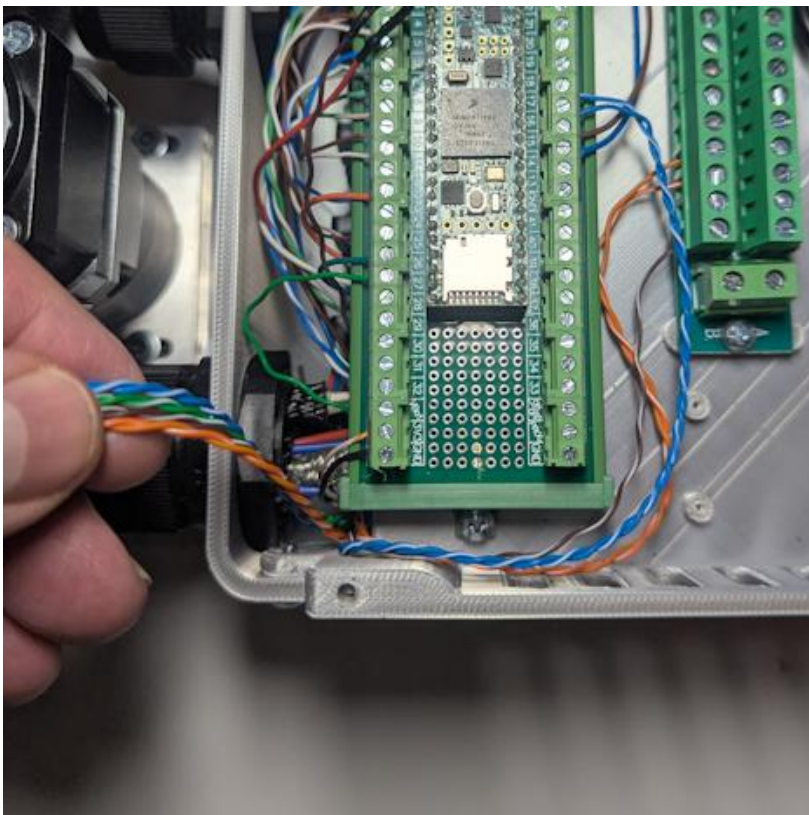

Locate the encoder and hall effect sensor CAT5 cables that were taped with 2 marked for J2 then route the wires as shown to come out above enclosure tray.

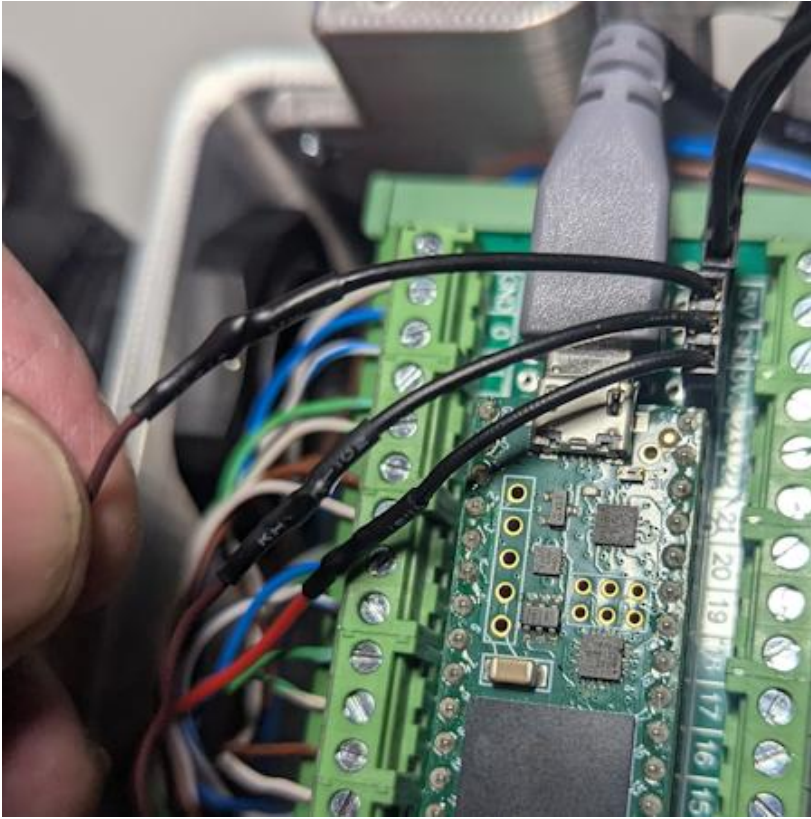

Un-twist the brown wire pair. Trim solid brown wire to length as shown in photo and solder - heat shrink the brown wire from the J3 encoder to the third wire on the Dupont 2.54mm 5v lead.

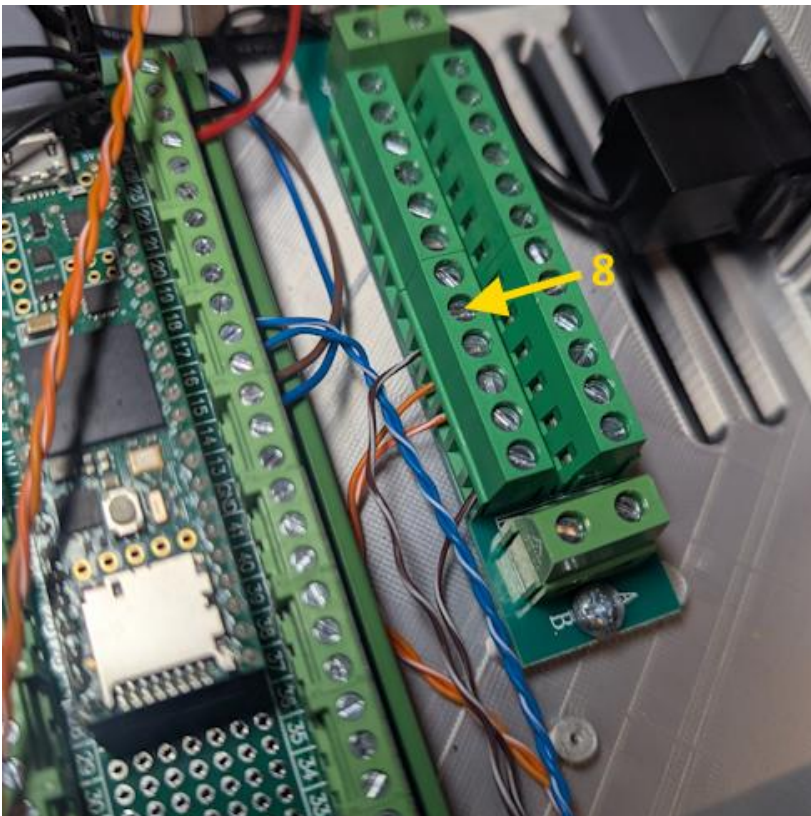

Route the brown/stripe wire over to the 2x12 terminal block and connect the wire to the 8th terminal as shown.

This is the GND wire from the J3 encoder. **Use Multimeter to verify** the terminal you connected to has continuity to the “B” or GND terminal on the terminal board.

NOTE: the “A” and “B” terminals ***alternate*** across the top and bottom terminal rows – the top are ***not*** all connected to “A” and the bottom are ***not*** all connected to “B”.

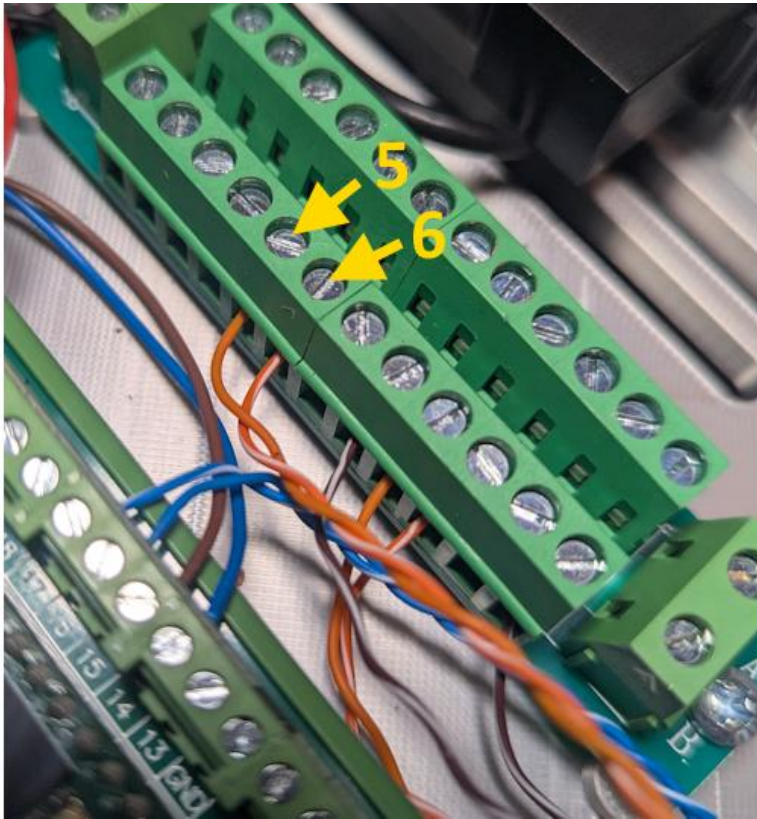

Route the orange pair over to the 2x12 terminal block and connect the solid orange wire to the 5th terminal & the stripe wire to the 6th terminal.

Use Multimeter to verify the solid orange wire has continuity to the “A” or +3.3v terminal and that the stripe wire has continuity to the “B” or GND terminal at end of terminal board.

NOTE: the “A” and “B” terminals **alternate** across the top and bottom terminal rows – the top are **not** all connected to “A” and the bottom are **not** all connected to “B”.

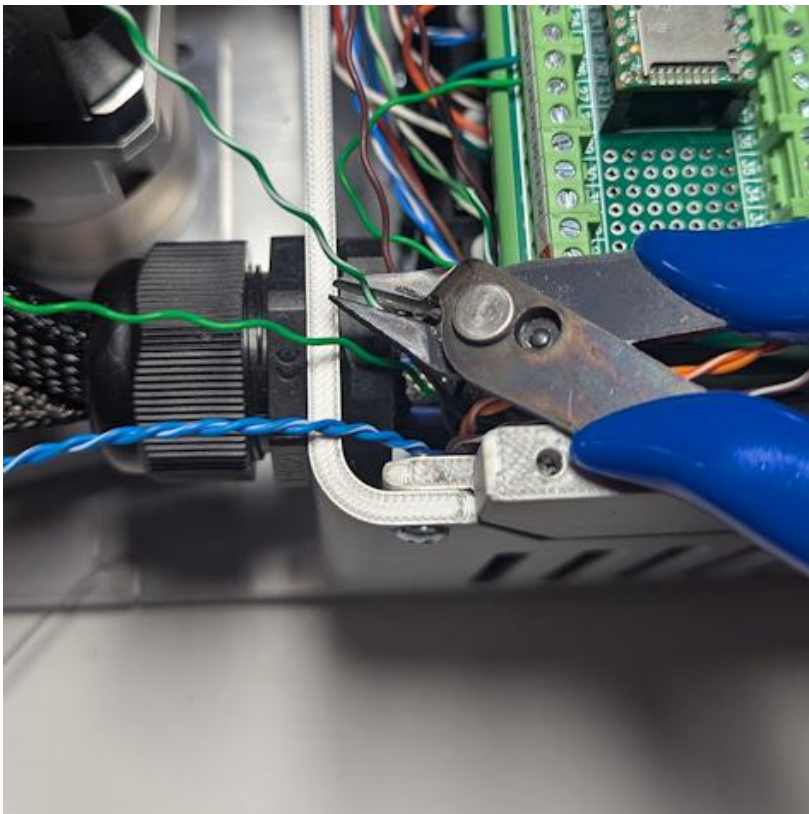

Un-twist the green wires and trim the stripe wire as shown as it will not be used.

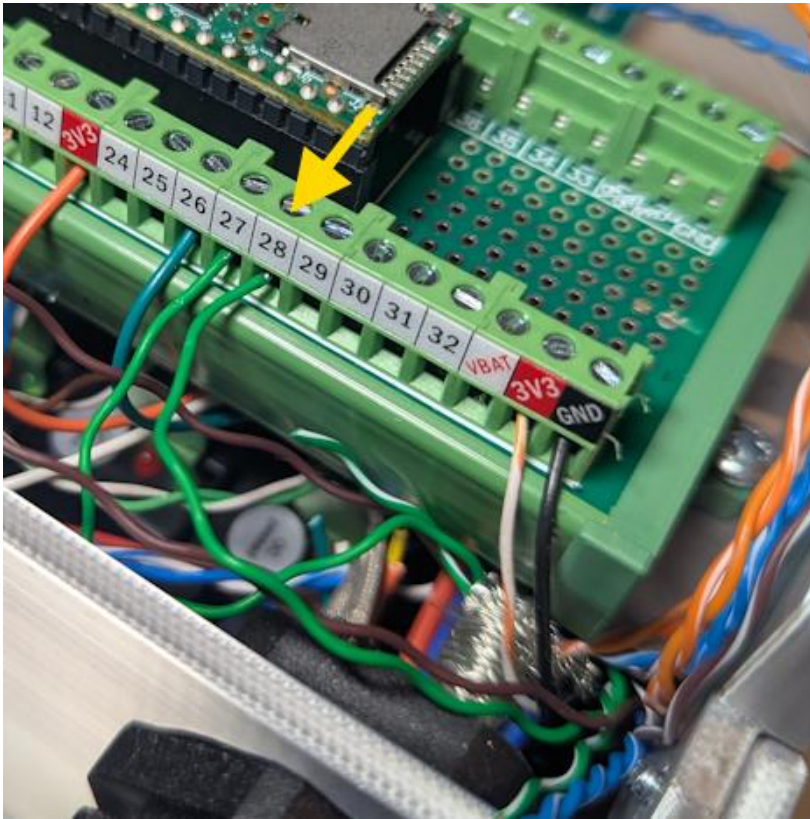

Route and trim the solid green wire to terminal **28** and connect as shown.

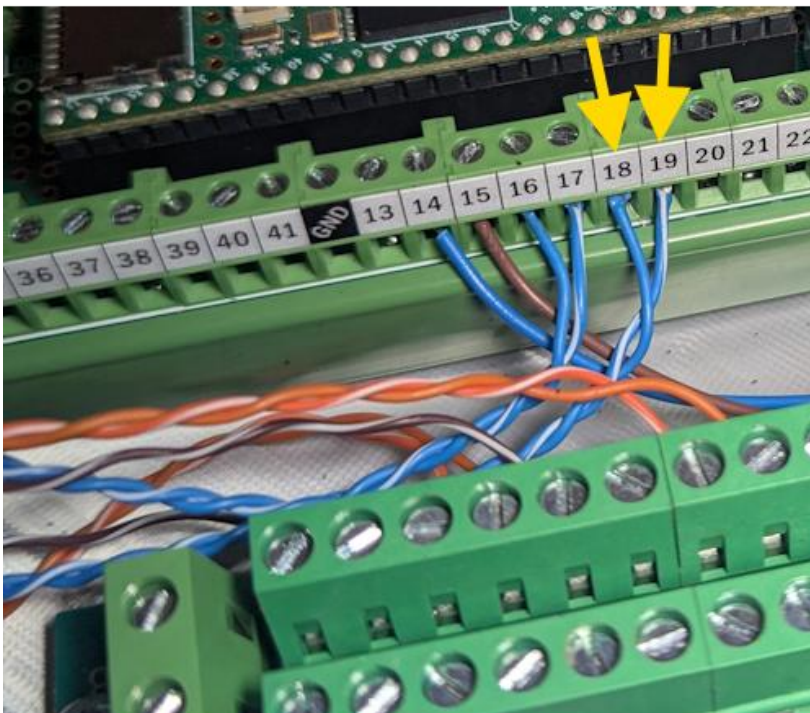

Route and trim the blue twisted pair over to terminals 18 and 19.

Connect the solid blue wire to terminal **18**

Connect the stripe wire to terminal **19**.

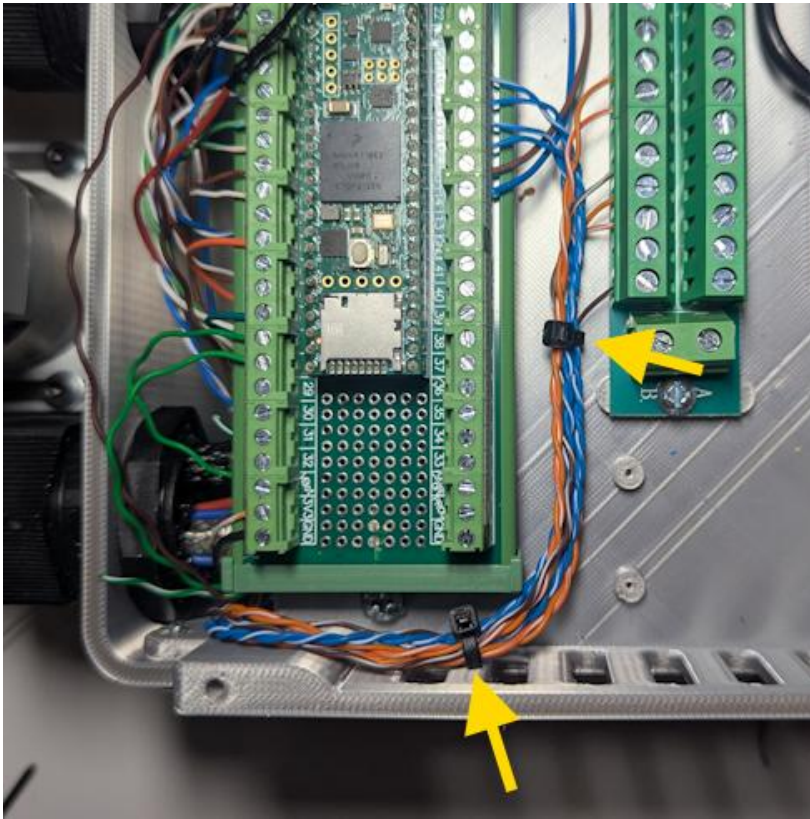

Use a small cable tie to bundle the J1, J2 and J3 encoder wires as well as the wires going to the terminal block as shown.



Secure AR4 logo into recess in J2 side cover using epoxy.



Install J2 side cover spacer and rest in place over the J3 belt and pulley as shown.



Position the J2 side cover over the side spacer as shown, align the holes and install (1) M3x30 pan head screw.

Please note: if you don't have a large bed printer this part is available to print in 2 pieces – see the folder ["Large Parts Split for Smaller 3D printer"](#)



With the side cover and spacer held in place by the first screw now install the remaining (15) M3x30 pan head screws as shown.



Press (2) B-1616 needle roller bearings into the J4 turret housing (install one on each side).

NOTE: don't forget to add a small amount of grease to needle bearings.

NOTE: This bearing can be a tight fit – please make sure to read the notes on bearing fit in overview section. I recommend heating the housing on a mug warmer prior to pressing needle roller bearings into housing. Please use a quality press and never hammer parts into place.



Secure J4 turret housing to J3 spindle using (2) M4x14 flat head screws (center) and (4) M4x10 cap screws (outer).

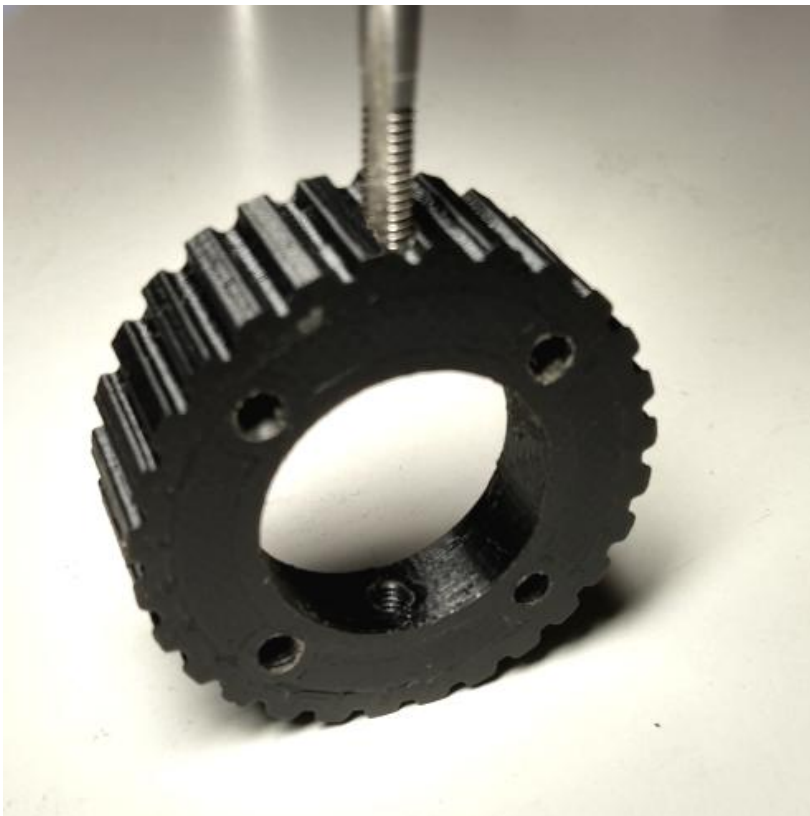

Use an M4 tap to thread each of the (4) holes around the perimeter of the J4 Timing Pulley.

NOTE: Do not use oil or lubricant on tap as you normally would when tapping metal. I have found it helpful to hold part & tap under cold running water while tapping holes.



Use an M4 tap to thread each of the (4) holes on the face of the J4 Timing Pulley as shown.

NOTE: It is important that the J4 timing pulley is no thicker than 15mm. If your 3D print is any thicker than 15mm use flat file or sandpaper on flat glass surface to carefully remove any excess material from the flat side shown.



Install J4 timing onto J4 main shaft and make sure one of the perimeter threaded holes aligns with the 2nd hole in J4 main shaft (yellow arrow)

Verify the distance from the end of shaft to face of pulley is 25.3mm

Install (1) M4x10 set screw into the threaded hole that aligns with the 2nd hole in J4 main shaft (yellow arrow) – make sure set screw threads into J4 main shaft approx. 3 turns. This screw locks the alignment of the pulley and shaft.

Install and snug (3) M4x5 set screws in the remaining perimeter holes.



Install (1) TRD1625 (.126" thick) bearing washer over J4 main shaft and into J4 timing hub recess as shown.



Install (1) NTA1625 (1" ID) need roller bearing over J4 main shaft and into J4 timing hub recess as shown.

NOTE: don't forget to add a small amount of grease to needle bearings.



Install (1) TRA1625 (.032" thick) bearing washer over J4 main shaft and into J4 timing hub recess as shown.



Install J4 tube / timing hub assembly into the J4 turret as shown.

Make sure bearings are fully seated in timing hub recess and flush to J4 turret housing.



Install (1) M3x6 button head cap screw into J5 motor housing as shown. Do not fully seat the screw, leave one or two threads exposed. This screw will need to be adjusted when it comes time to test the auto calibration.

This screw serves as a timing lug for the J4 limit switch.

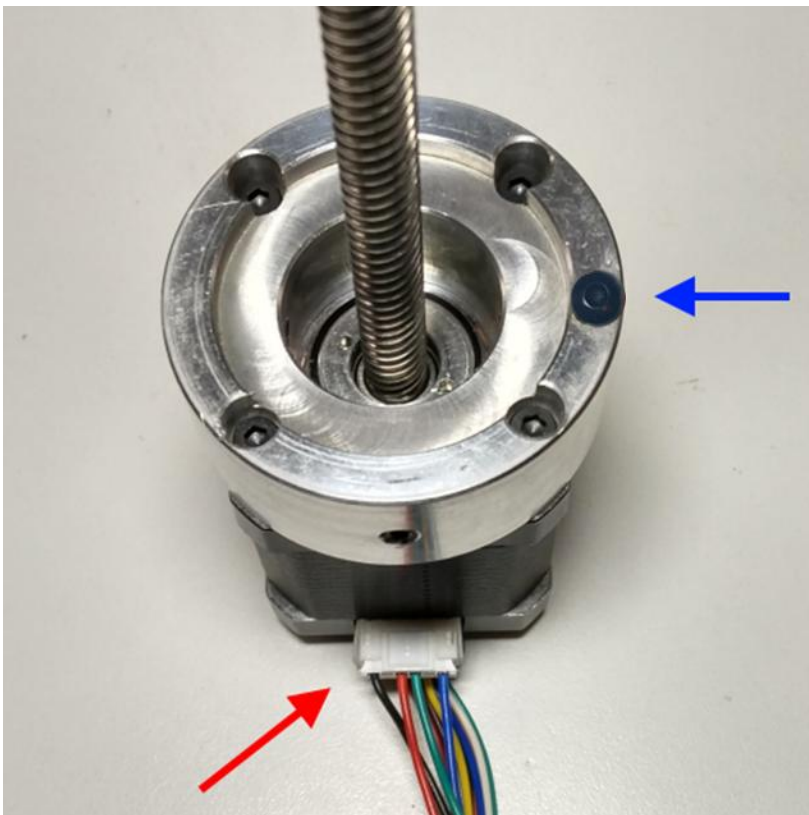

Secure J5 motor mount using (4) M3x16 socket head cap screws.

Note the motor connector is facing downward (red arrow) and the timing lug screw is 90° to the right (blue arrow).

NOTE: un-thread and remove the plastic POM nut that comes threaded onto motor shaft prior installing J5 motor mount.



Install (1) TRA1625 (.032" thick) bearing washer over J5 motor shaft and into J5 motor mount recess as shown.



Install (1) NTA1625 (1" ID) need roller bearing over J5 motor shaft and into J5 motor mount recess as shown.

NOTE: don't forget to add a small amount of grease to needle bearings.



Install (1) TRA1625 (.032" thick) bearing washer over J5 motor shaft and into J5 motor mount recess as shown.



Install J5 motor assembly into J4 main tube as shown.

Be careful that bearings stay in place in J5 motor mount and slide over the end of the J4 main tube. When J5 motor mount is fully seated over J4 main tube and bearings are flush to J4 housing secure J5 motor mount to J4 tube using (4) M4x10 set screws. With motor connector facing down the set screw facing out (red arrow) should seat into hole in J4 main shaft.

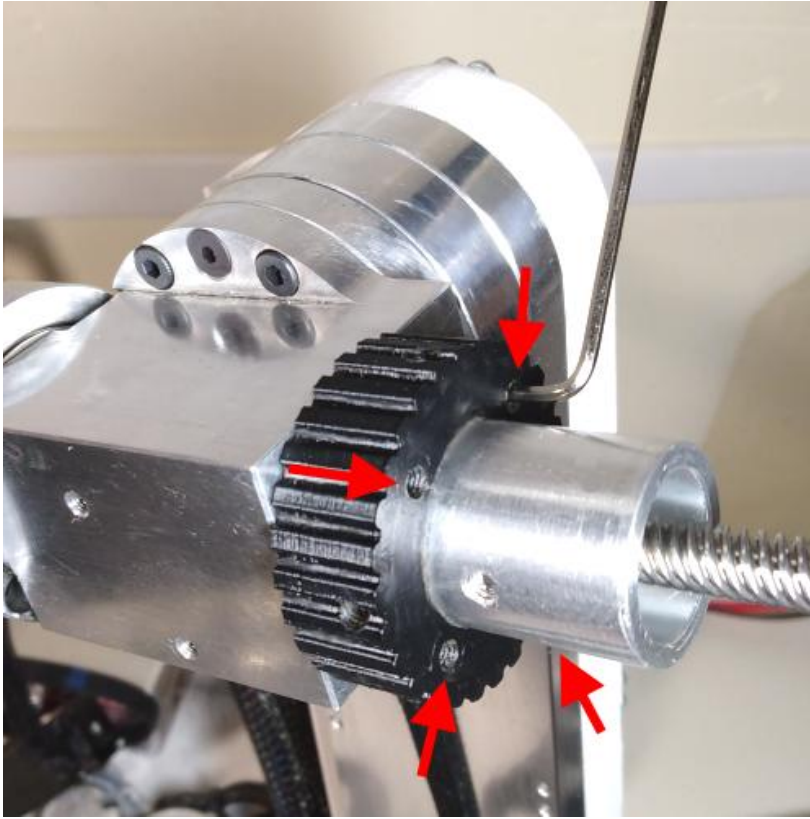

Install (4) M4x5 set screws into J4 timing hub in locations shown with red arrows.

Apply light tension to each screw, these screws will apply tension on all of the J4 bearings. Make sure screws are tensioned such that there is no play in bearing but not too much tension so that the motor and shaft still spin freely in housing.



Place 4mm x 4mm magnet on the tip of a flat blade screwdriver as shown.

Hold the magnet up to a magnet polarity tester and make sure the North side of the magnet is facing out and that the south side is connected to the screwdriver.

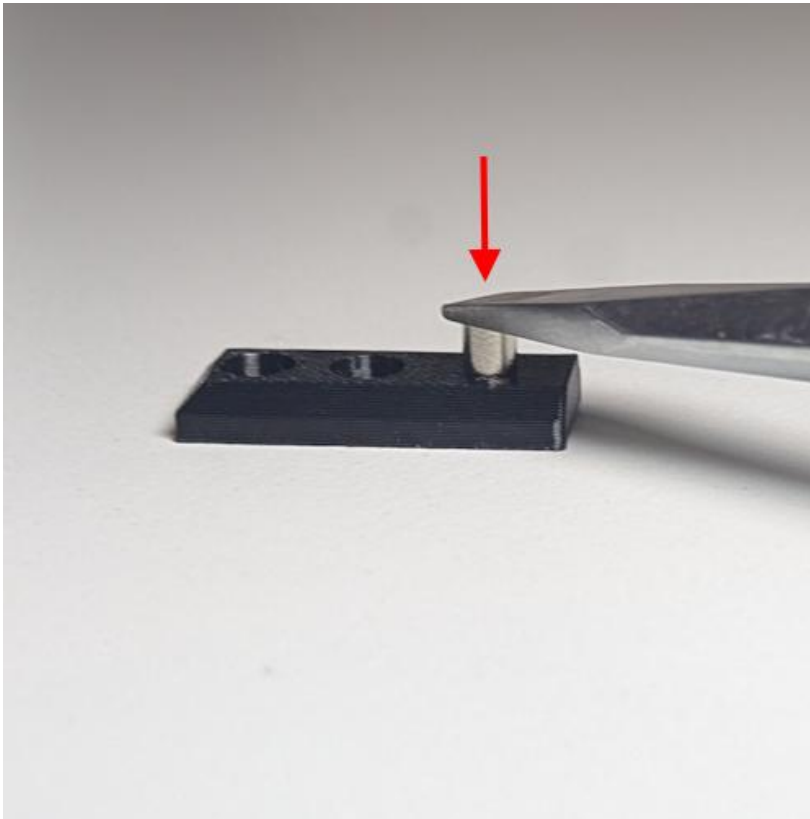

Using flat blade screw driver, press magnet into 3D printed J3 Magnet Mount.



Secure J3 magnet mount to J4 motor mount block as shown using (2) M2.5x6 pan head screws.



Use magnet polarity tester to verify the south side of magnet is facing out.

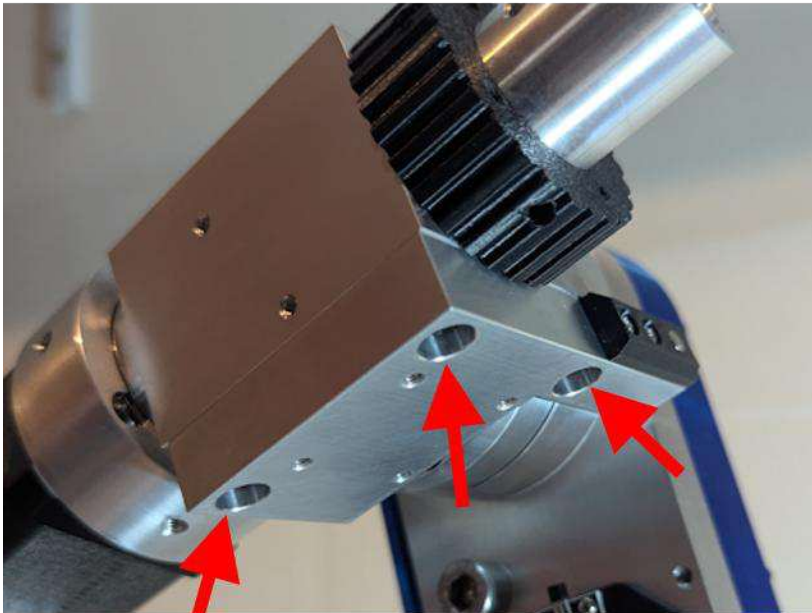

Install J4 motor mount / limit switch contact block as shown and secure with (3) M4x10 socket head cap screws.



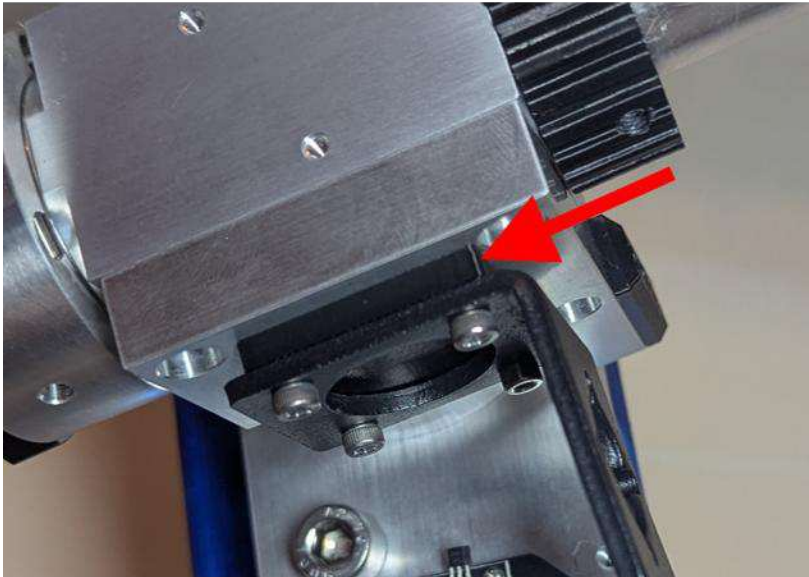

Install Nema 11 motor mount bracket as shown, place the 3D printed part “**J4 motor spacer – 4mm**”

between the bracket and the aluminum (red arrow).

Secure with (4) M3x14 socket head cap screws.

The 3D print files comes with 3mm, 4mm and 5mm thicknesses of the “J4 motor spacer” so that you have some options to tension the belt given any variation but I have found the 4mm version typically best.

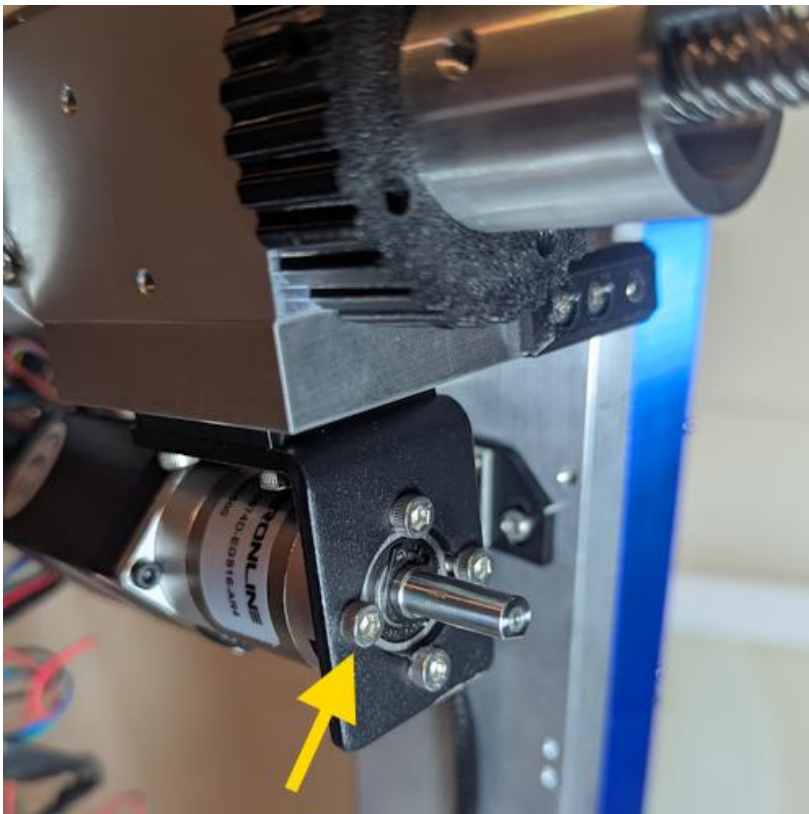

Install J4 motor and secure with (4) M3x5 socket head cap screws.

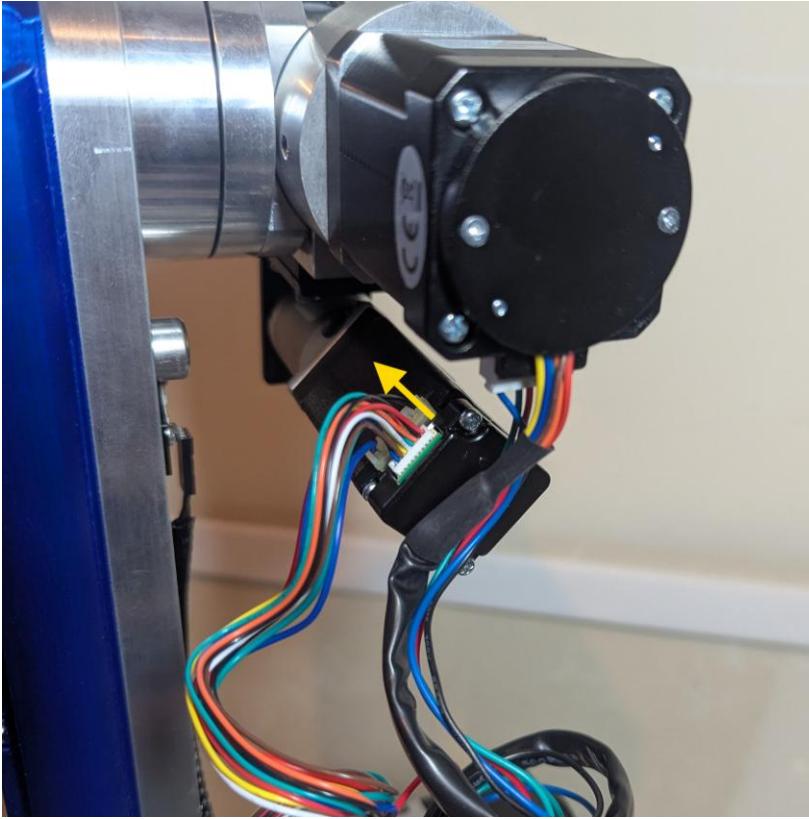

When installing the J4 motor make sure the motor and encoder wires are facing in toward the J2 arm as shown.



Install XL 10 tooth 6mm bore drive pulley onto J4 motor shaft and secure with (2) M3x4 set screws.

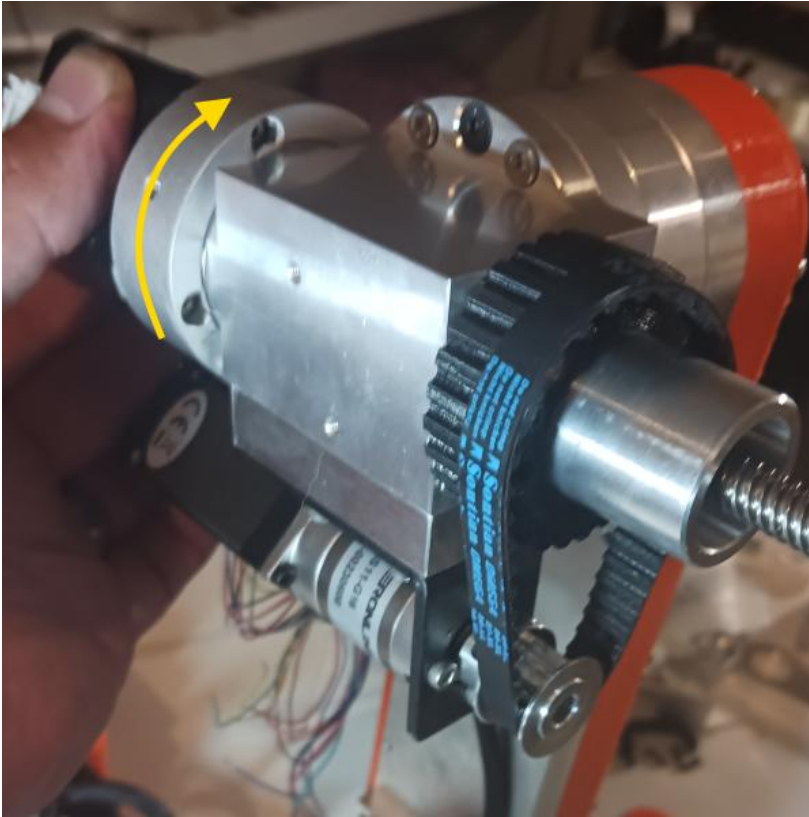

Install 84XL037 timing belt.
Place belt over the 10 tooth J4 motor pulley and then up over the main shaft sprocket – rotate the J5 / J4 assembly as belt rolls onto sprocket.

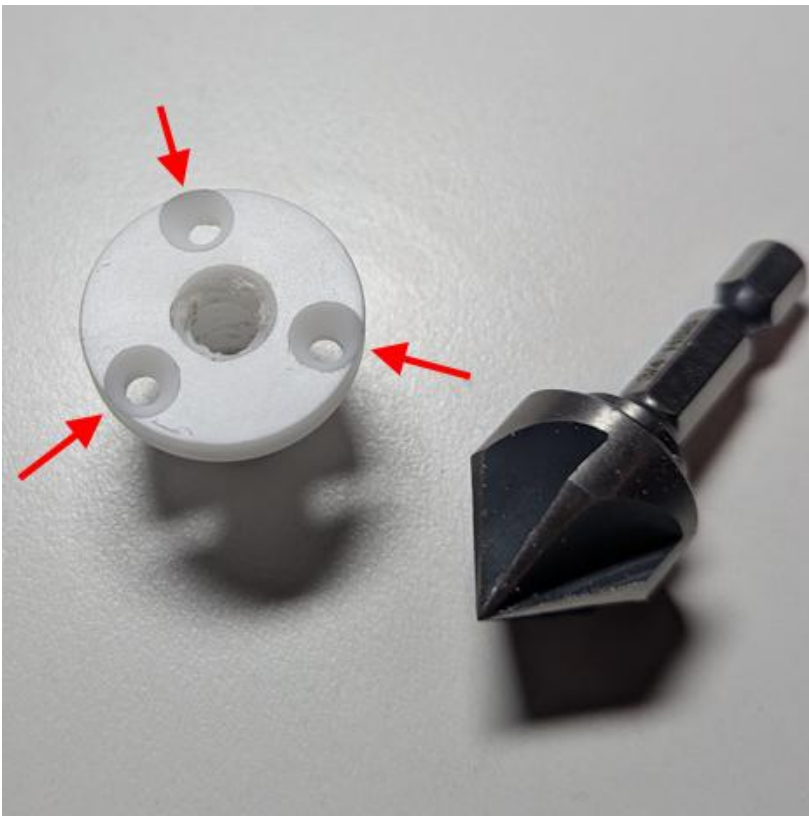

Countersink the (3) holes in POM nut that came with the J5 linear screw motor.

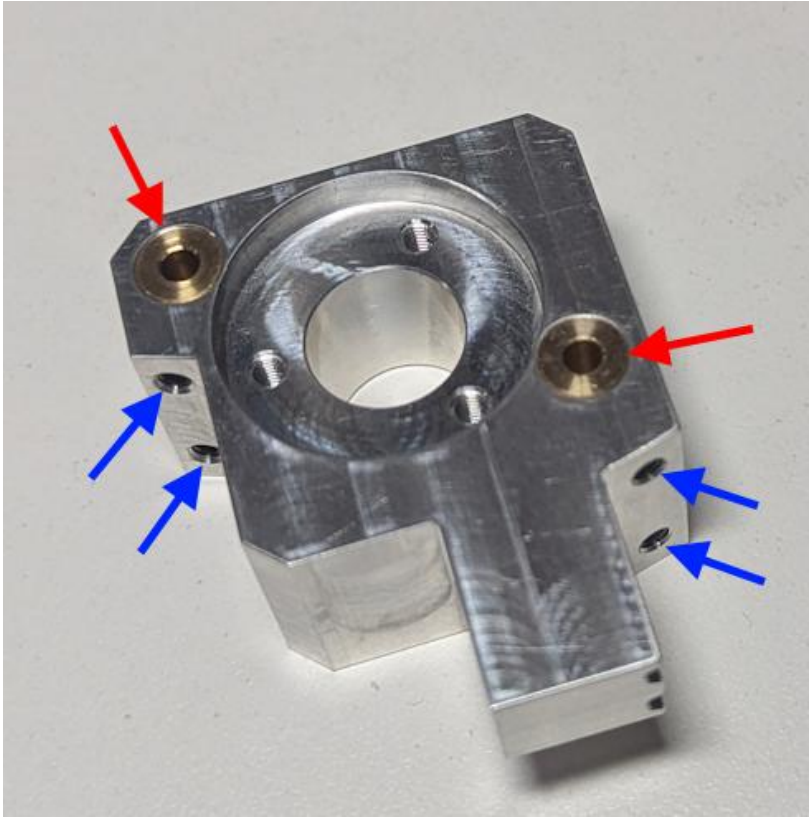

Press (2) 3mm ID x 20mm long brass bushings into the J5 carrier as shown (red arrow).

NOTE: these can be a tight fit. If needed warm the carrier on a mug warmer prior to installation. Use a press or quality vice with protection over the jaws. **DO NOT HAMMER THESE IN PLACE!!**

Secure bushings in carrier using (4) M3x4 set screws. (blue arrows)



Install POM nut into the J5 carrier as shown and secure with (3) M3x10 flat head screws.

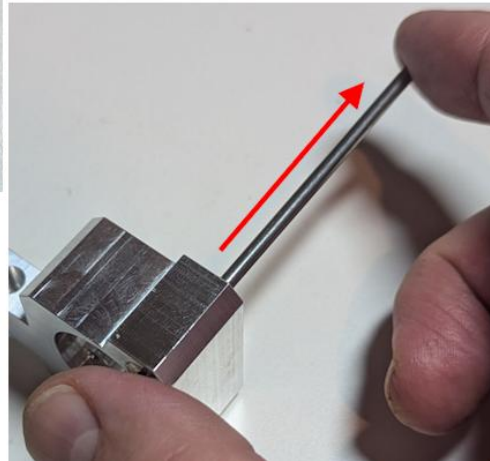
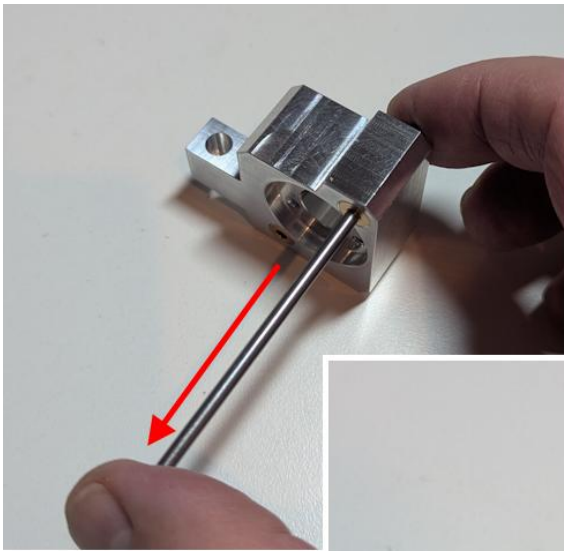

Test fit the 3mm rods in each bushing – slide the rod side to side several times and verify the rods slide smoothly in bushings.



The rods are a tolerance fit but if you find the rods don't slide smoothly you can "run in" the bushings by placing the end of one of the rods into a drill, apply grease to the rod and then run it back and forth through the bushing while turning the drill at speed. After running it through the bushing for a short period of time the rods should slide smoothly through the bushing.

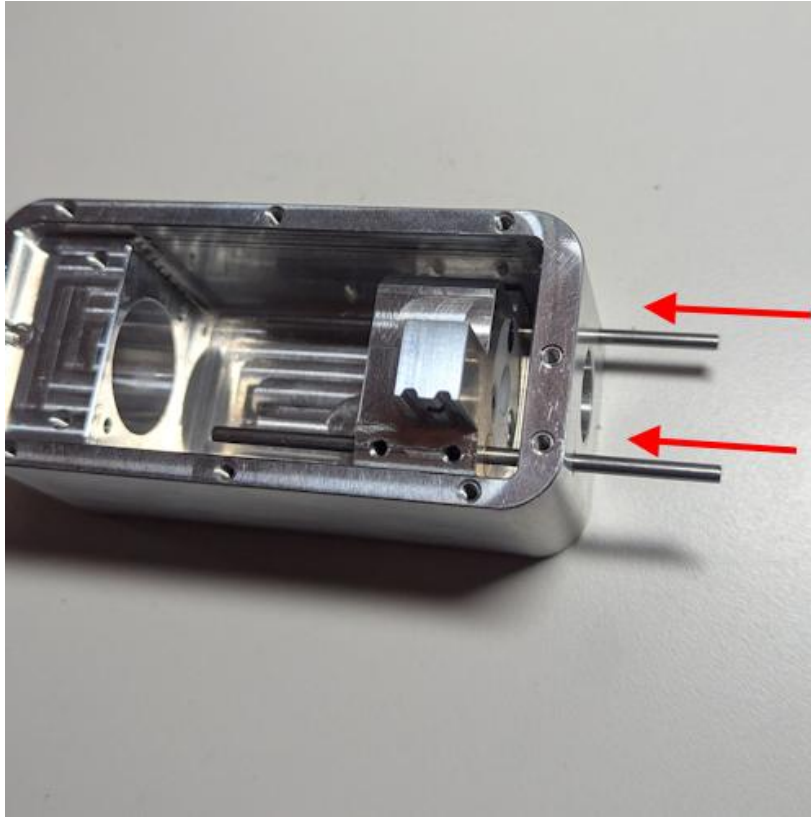

Place J5 carrier inside of the J5 housing, then install (2) 3mm linear rods through the J5 carrier bearings as shown.

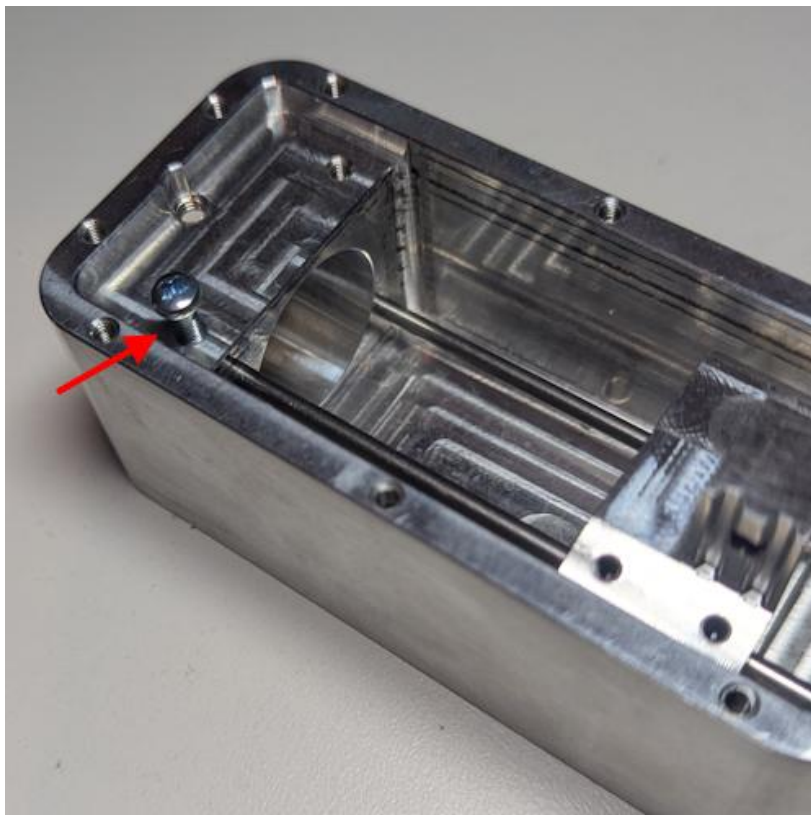

Temporarily install M3x8 screw fully threaded into hole as shown (red arrow) – this will prevent the 3mm rod from going too deep and blocking the hole.

Finish sliding the 3mm rods into place.

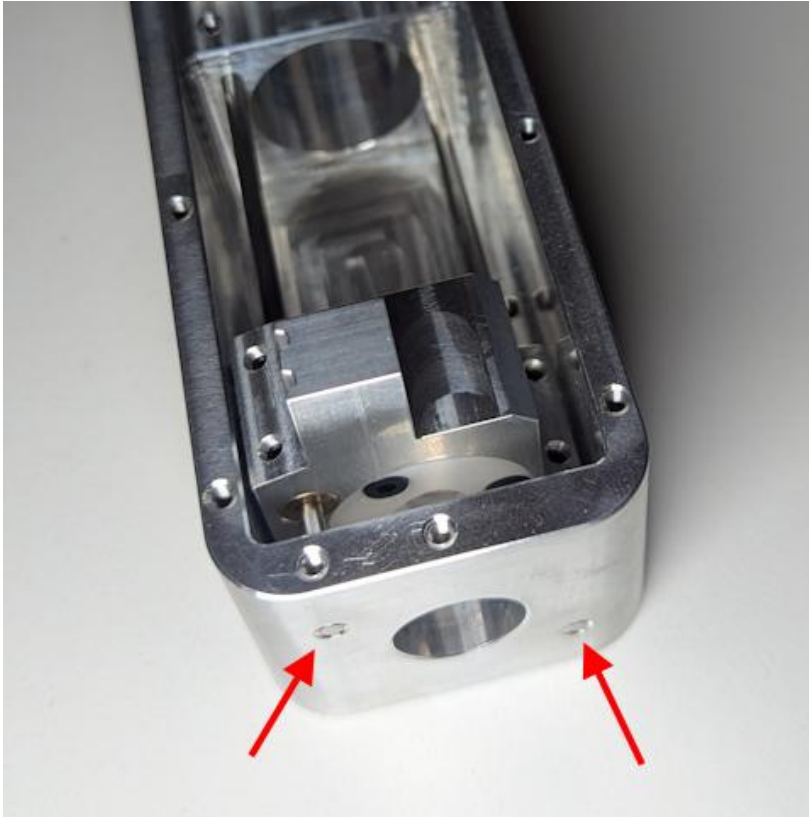

Rods should be fully inserted and flush to surface as shown.

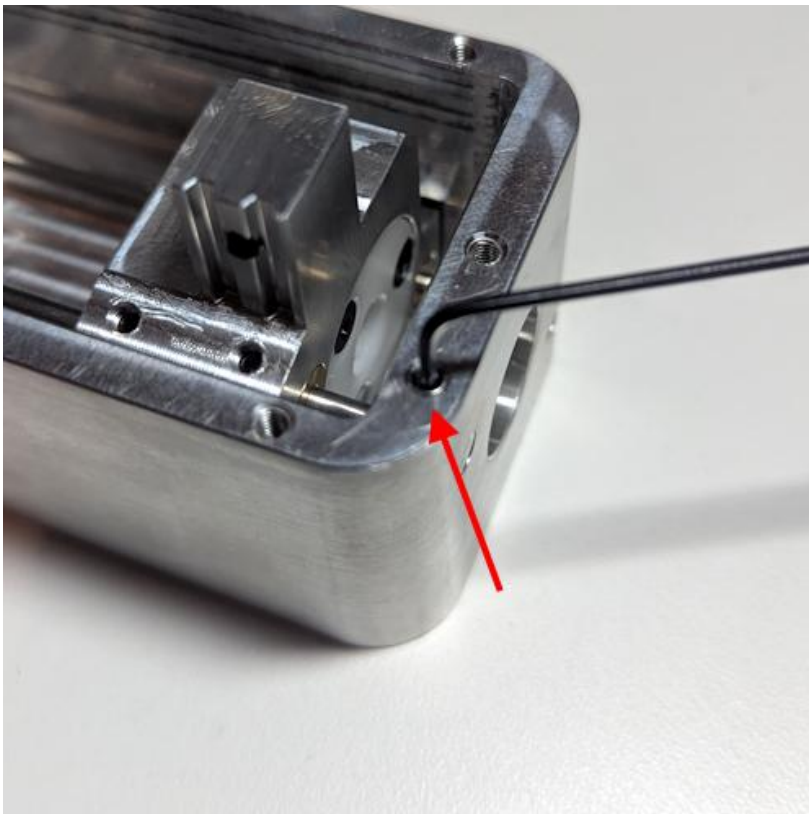

Secure bottom 3mm rod in place using (1) M3x6 set screw as shown (red arrow).

Then remove the M4 screw that was placed temporarily to prevent the rod from inserting too far.

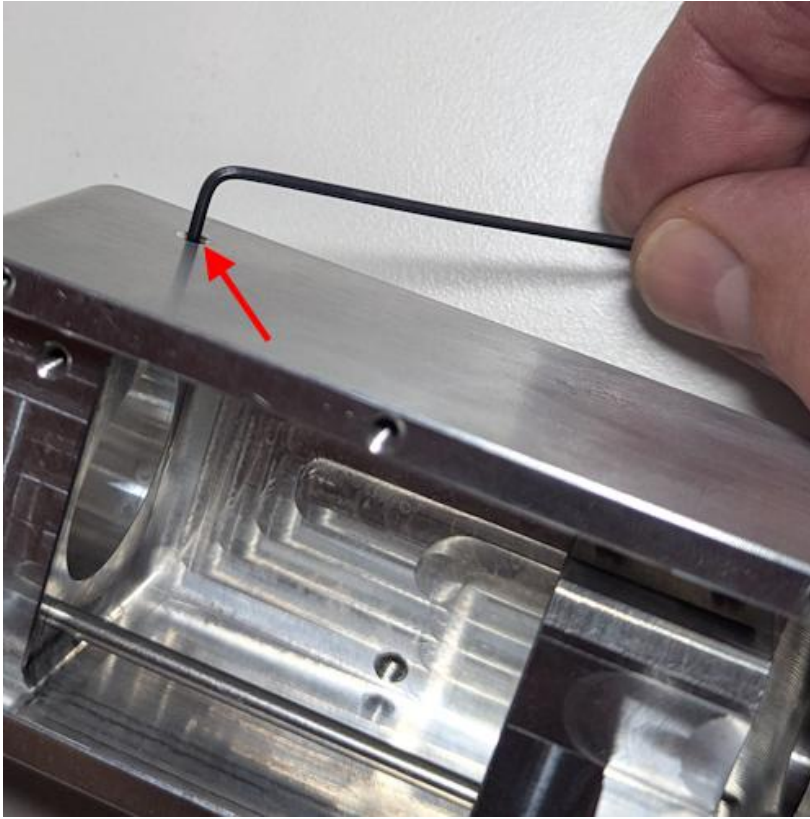

Secure top 3mm rod in place using (1) M3x6 set screw as shown (red arrow).

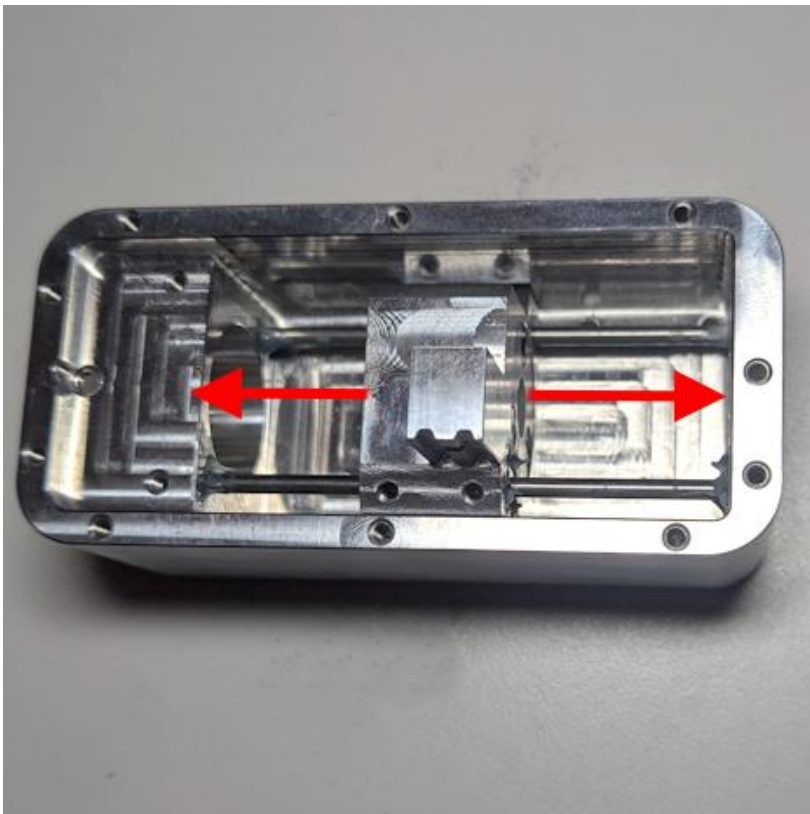

Make sure the J5 carrier slides smoothly in both directions. If you find there is any binding apply grease to the rods and move the carrier back and forth by hand until the bushing are broken in and the carrier slides easily. If you have trouble or find there is any binding you may need to remove the rods and repeat the earlier step using a drill to run in the bushings.



Install the J5 idler tension block and secure with (2) M4x8 socket head cap screws.



Install HK1612 bearing over the J5 bearing post as shown.



Install 3D printed bearing post spacer over the J5 bearing post as shown.



Install the bearing post and bearing to the J5 tension block using (1) M4x14 socket head cap screw as shown.

NOTE: leave the cap screw slightly loose – do not tighten at this time.



Install 688Z bearing in end of J5 housing as shown and then secure with M3x6 set screw (red arrow).

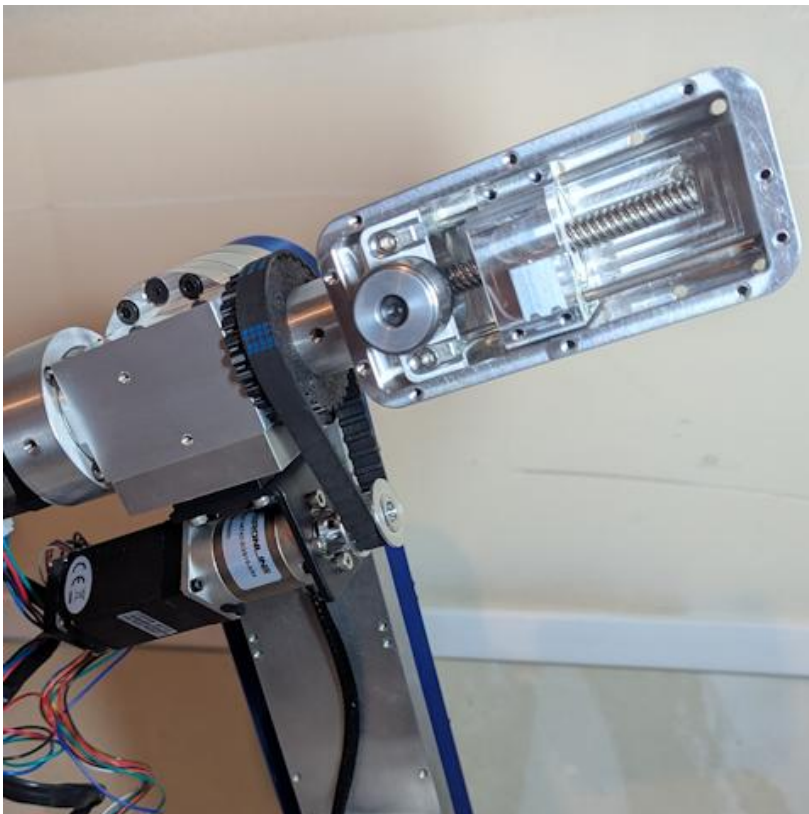

Spin J5 housing assembly onto J5 motor lead screw as shown.

NOTE: as you spin the carrier onto the lead screw the housing will start to insert onto the J4 main tube. **Make sure both the housing and main tube have been completely cleaned** and that there is no dust, debris, shavings or any other contaminants that could cause the housing to gall or get jammed on the main shaft – make sure the housing slides onto the main shaft smoothly.

Slide J5 housing assembly forward onto J4 main tube until fully seated against J4 timing hub.

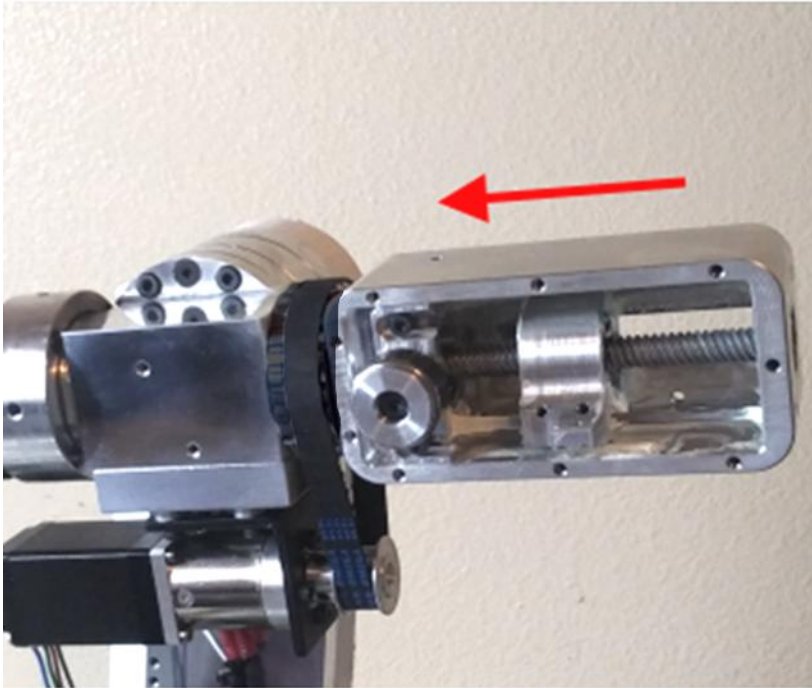

Do not force or twist into place – if it does not slide on by hand then polish J4 main shaft before inserting.

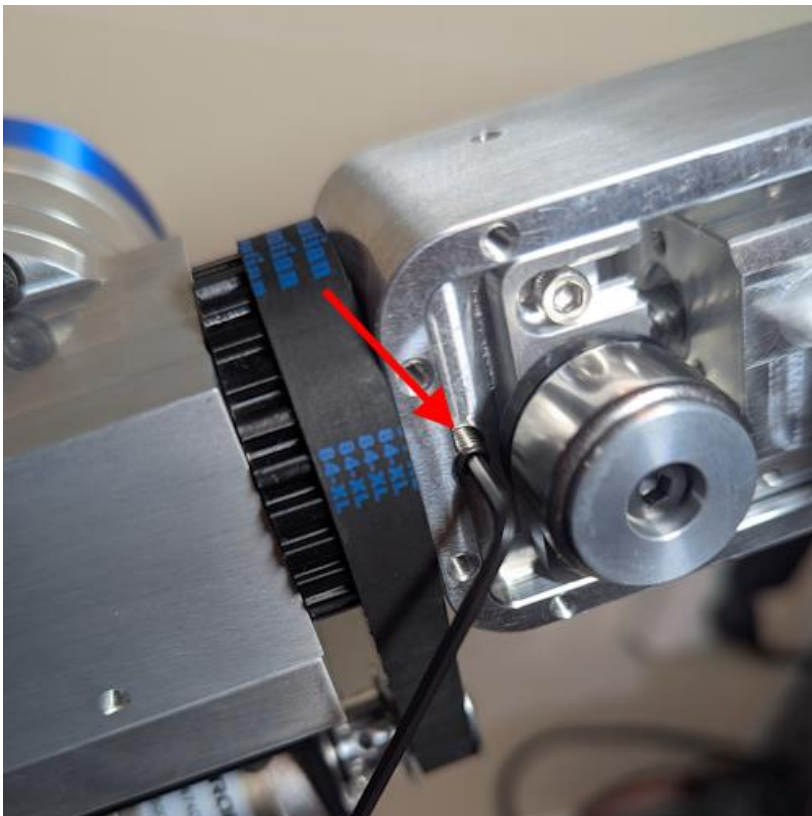

Install M4x10 set screw (red arrow) to secure J5 housing to J4 main tube, make sure screw fully threads into hole in J4 main shaft to ensure clocking is correct and housing is secured to main shaft.



Press #30203 taper roller bearing race into J6 main bearing support arm.

(See notes on bearing fit in overview section)

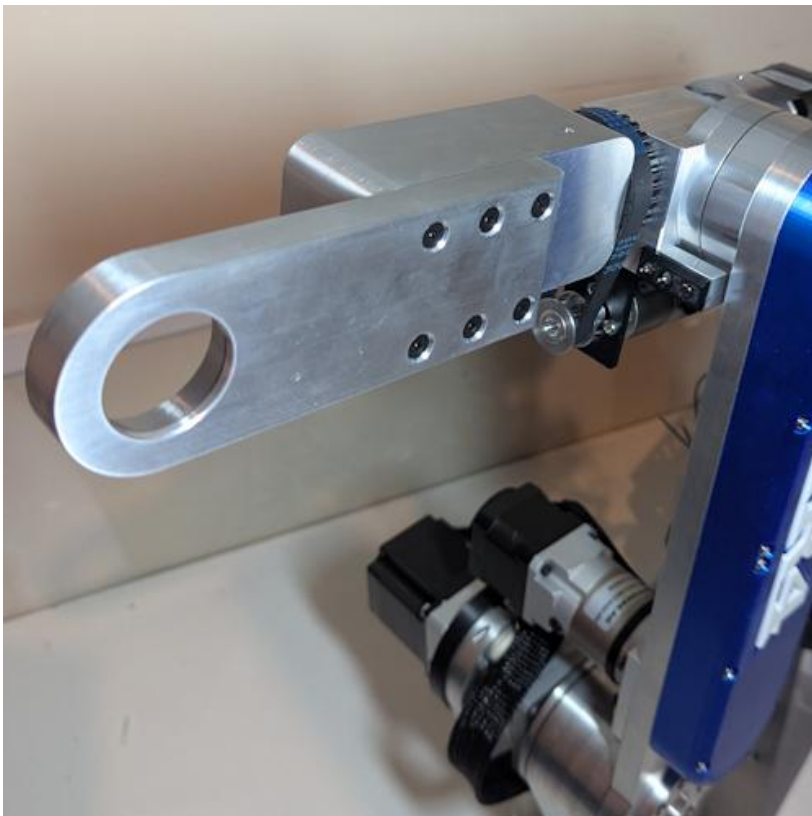

Secure J6 main bearing arm to J5 housing using (6) M4x18 flat head screws.



Press #30203 taper roller bearing onto J6 housing side post.

NOTE: don't forget to add a small amount of grease to taper bearings.

(See notes on bearing fit in overview section)



Install (1) TRD1625 (.126" thick) bearing washer into J6 bearing cap recess as shown.





Install (1) NTA1625 (1" ID) need roller bearing into J6 bearing cap recess as shown.

NOTE: don't forget to add a small amount of grease to needle bearings.



Install (1) TRA1625 (.032" thick) bearing washer into J6 bearing cap recess as shown.





Install J6 housing from left side as shown and then install the J6 bearing cap (with bearings) from the right. Secure bearing Cap to J6 housing using (1) M6x14 socket head cap screw.



Install (6) M4x5 set screws in perimeter of bearing cap.

These set screws will apply tension on J6 bearings.

Set tension evenly on all set screws so there is no play J6 housing rotation but also that it rotates smoothly.

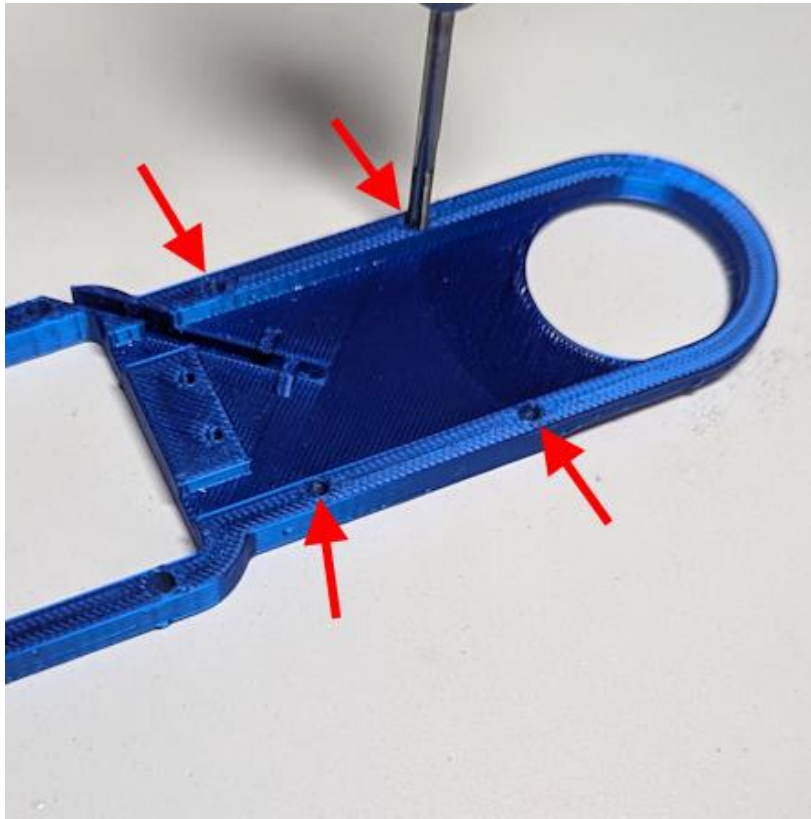

Use M3 tap to thread the front (4) holes in J5 side plate (red arrows).

NOTE: pre-drill or cleanout holes using a 2.5mm drill. Do not use oil or lubricant on tap as you normally would when tapping metal. I have found it helpful to hold part & tap under cold running water while tapping holes.

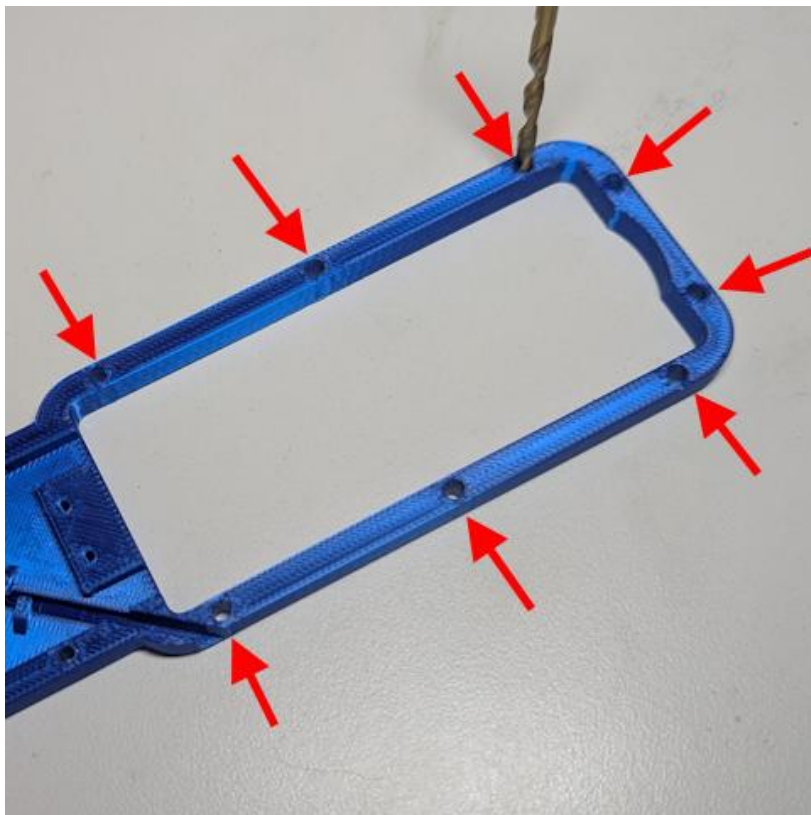

Use 3mm drill bit to clear the rear (8) holes on J5 side plate.



On reverse side of J5 side plate use flat file to clean up and remove any remaining build structure from the recessed nose area of side plate.

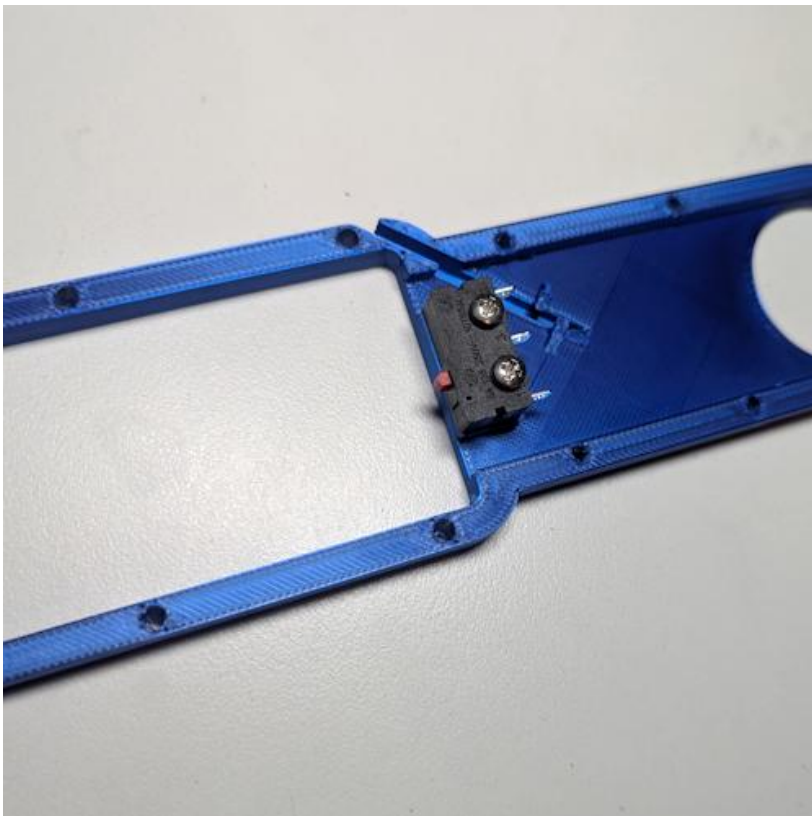

Secure 10T85 limit switch to J5 side cover using (2) M2.5x8 pan head screws as shown.

Make sure the red button is oriented or offset in the down orientation as shown, and the NC terminal oriented in the up position.

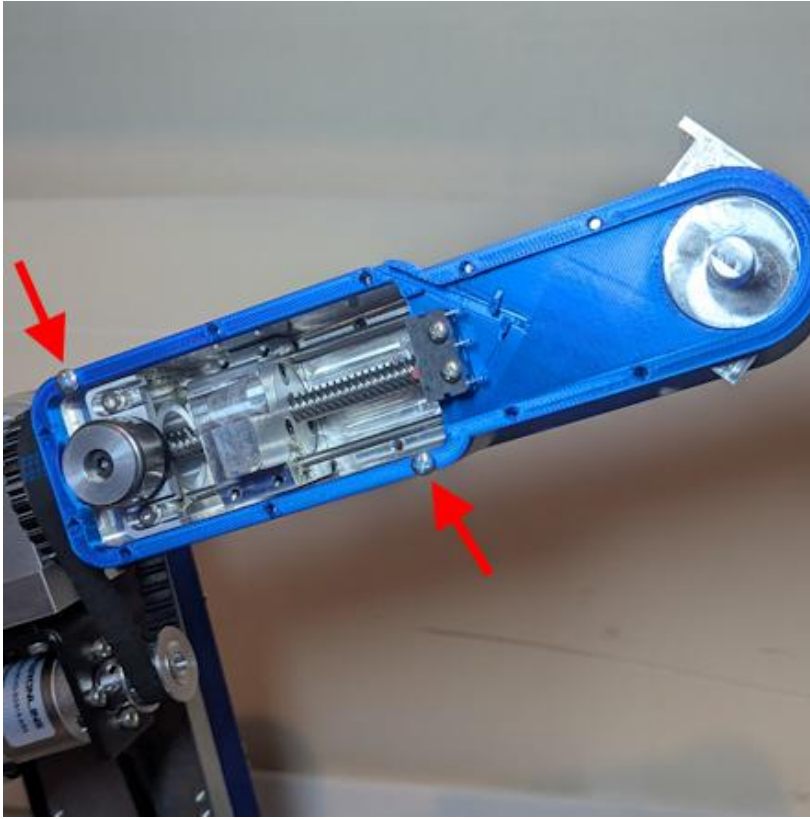

Install J5 side plate as shown, temporarily install (2) M3x14 philips head pan screws to hold side cover in place.



Install XL15 pulley onto J6 housing post as shown.

Make sure pulley bore and shaft are clean and free of any dust or debris.

If the pulley does not slide onto the J6 housing shaft easily do not force it. Clean shaft & pulley – polish the shaft if necessary to achieve a slip fit.

Do not install or tighten set screws at this time – **pulley should free spin on shaft.**

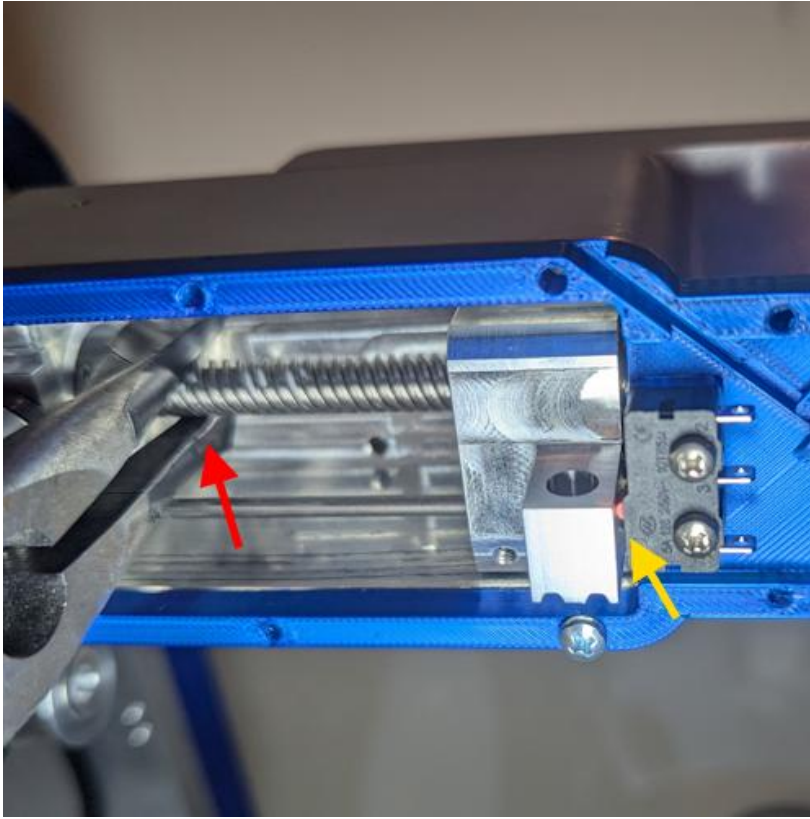

Place protective tape on jaws of needle nose pliers (red arrow) and then manually rotate the J5 motor lead screw until J5 carrier is all the way forward as shown.

Rotate motor lead screw until carrier contacts and trips limit switch (you should hear the limit switch click when the switch is made).



For Joint 5 - cut a length of continuous flex Cat6 cable to a length of 130cm long and remove outer jacket. (see overview section on jacket removal)

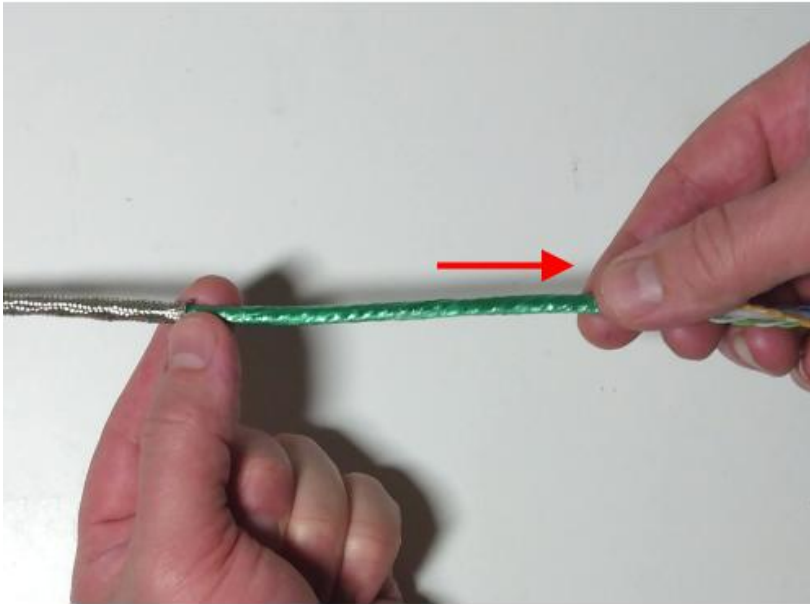

Joint 5 is a little different from the other joints due to the fact that the J5 limit switch is not located close to the J5 motor and the limit switch is on the other side of joint 3. Because of this we will need to run the J5 limit switch wires separately from the J5 encoder wires. To make this happen we will need to separate the J5 limit switch wires from the J5 encoder wires. To separate the wires first grasp the shielding in one hand and pull on all the wires with other – you want to remove all the wires completely from the shielding.

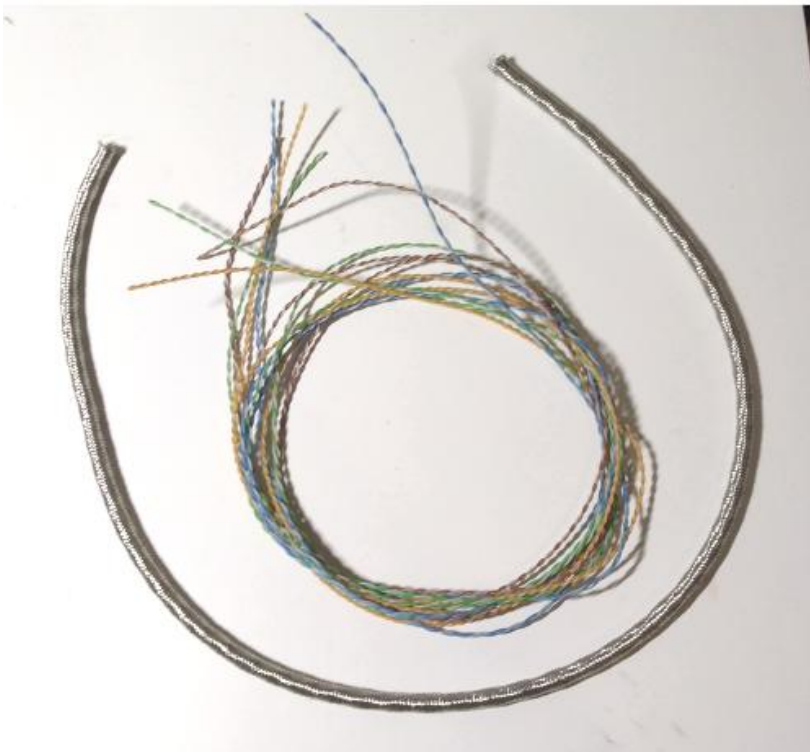

Pull all the wires out of the shielding and remove the green wrap and center core leaving just the shielding and the 4 twisted pairs.





In the next step we will use only the orange and green pairs for the J5 limit switch.

Save the blue and brown pairs and the shielding for a future step.

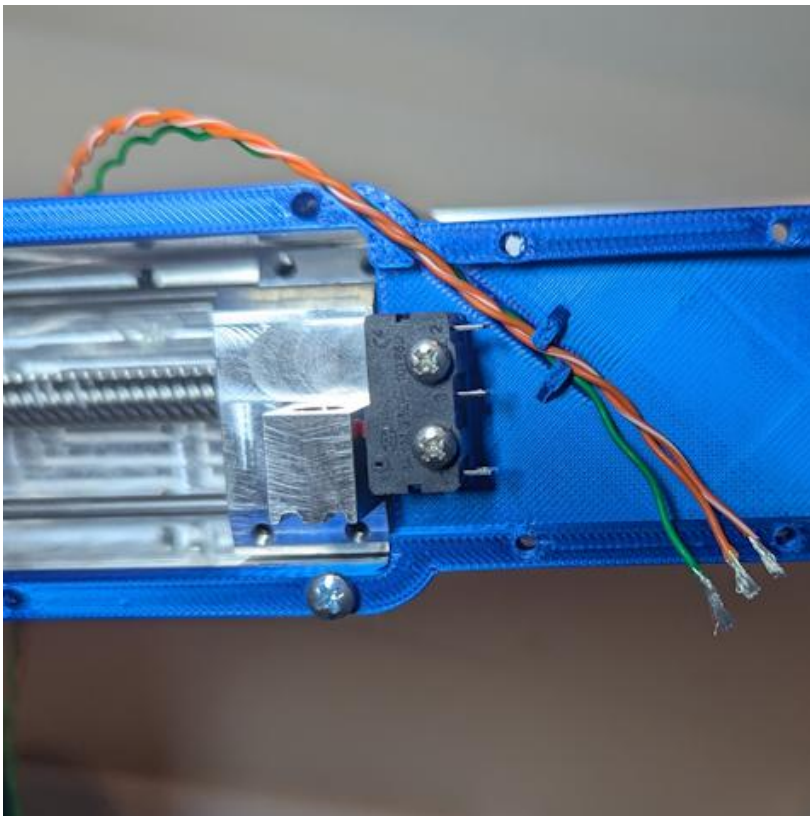

Un-twist the green pair of wires. Discard the stripe wire and keep the solid green wire.

Strip wire ends and then route the orange pair and solid green wire through the slot in J5 side plate as shown.

Make sure wires are routed under the 2 hold down fingers in side plate.

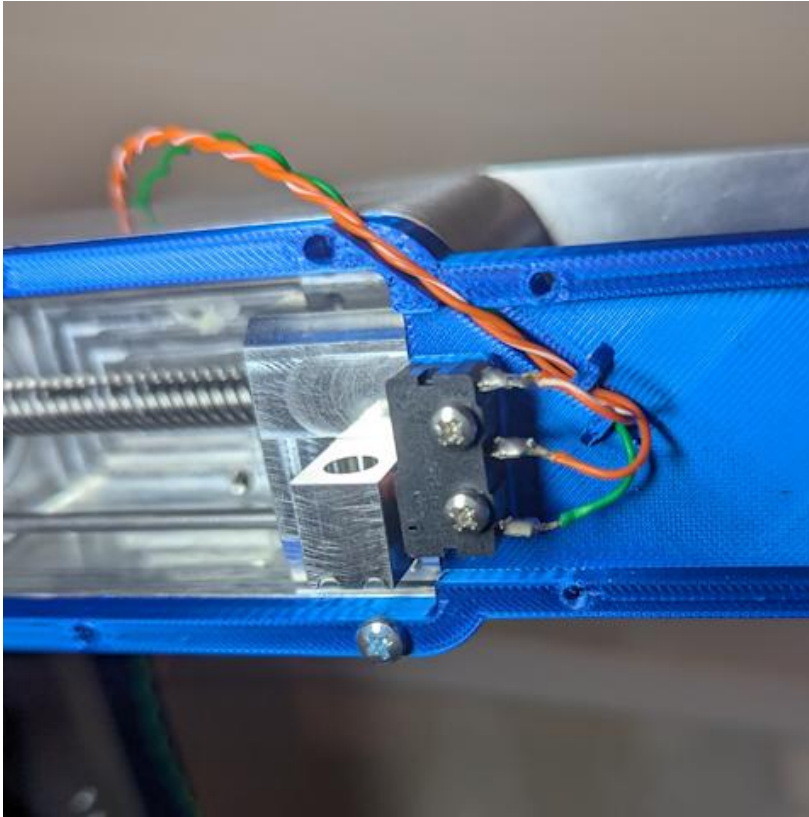

Solder orange wire to “NO” terminal of 10T85 limit switch.

Solder white with orange stripe wire to the “NC” terminal.

Solder the white with green stripe wire to the “C” terminal.

Note: the green wire is not used and should be trimmed back.

(also see wiring diagrams in chapter 4)

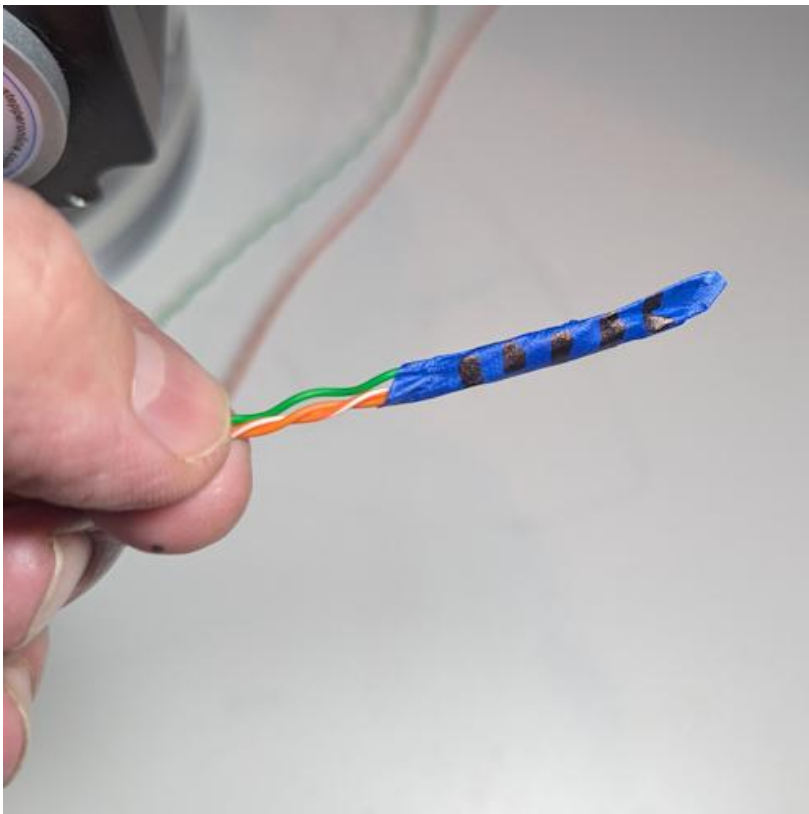

Apply tape to ends of the orange pair and green wire and mark with 5 stripes to indicate joint 5 so that these wires can be identified once routed into base enclosure.

Leave these wires draped off to the side – they will be routed along with the J6 wires in a future step.



Use 3mm drill bit to drill a hole in 150XL belt as shown.

Hole should be directly between 2 of the ribs and centered on belt.

NOTE: place belt on block of wood when drilling hole.

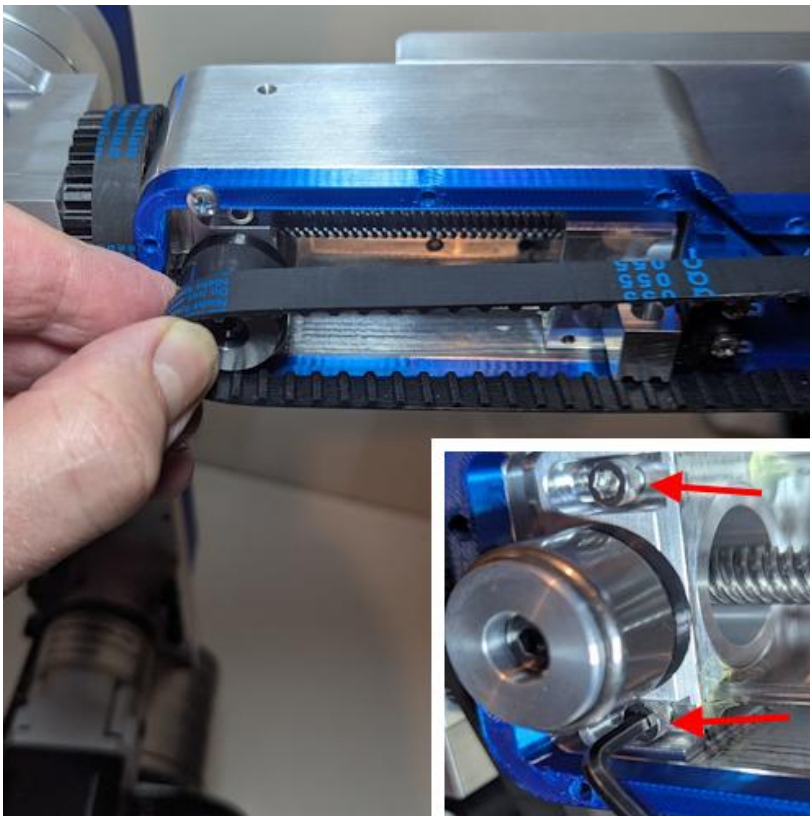

Adjust J5 idler tension block so that when you try to install the 150XL belt it is tight or is very difficult to slip over the idler bearing.

Once the tension block is positioned tighten the tension block cap screws as indicated by the red arrows.

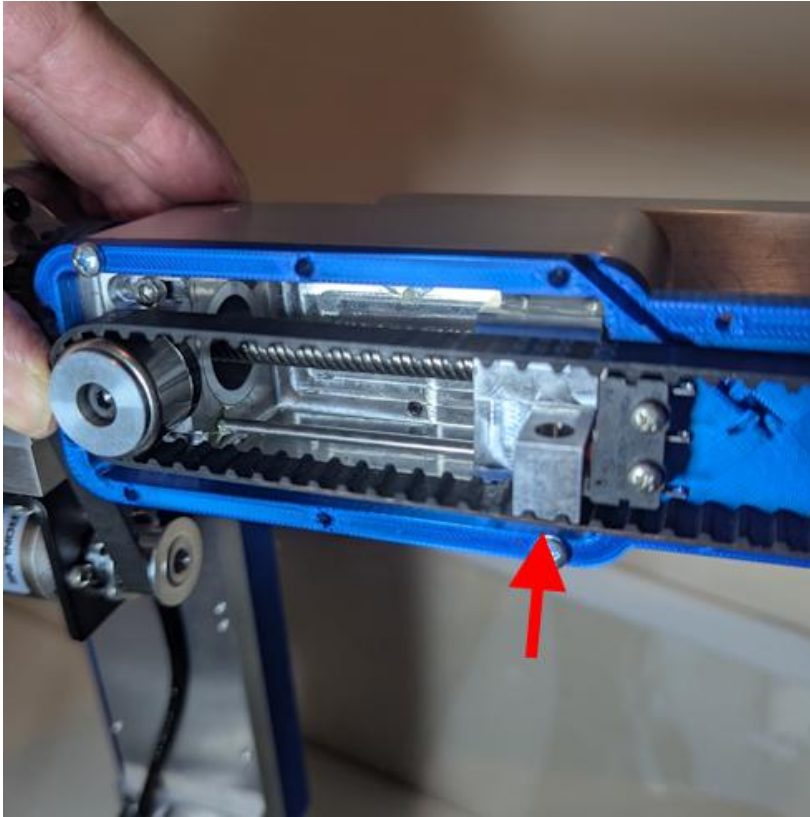

Slide / push belt over the idler bearing as shown.

Make sure the 3mm hole drilled in belt is aligned with the J5 carrier (red arrow)

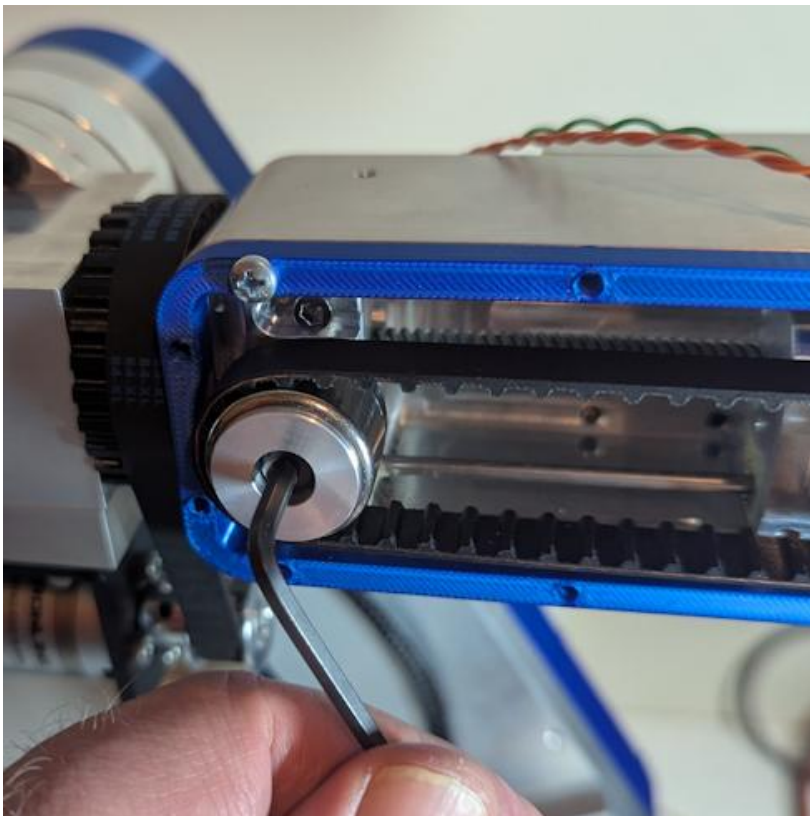

Tighten the J5 bearing post cap screw shown.

Given this screw was left slightly loose and the bearing tilted slightly forward when belt was installed – once this screw is tightened and the bearing secured perpendicular it will pull the belt a little bit tighter and should result in a tightly tensioned belt.

NOTE: If you are building a 3D printed robot you will not be able to achieve as tight a belt tension as with aluminum parts.

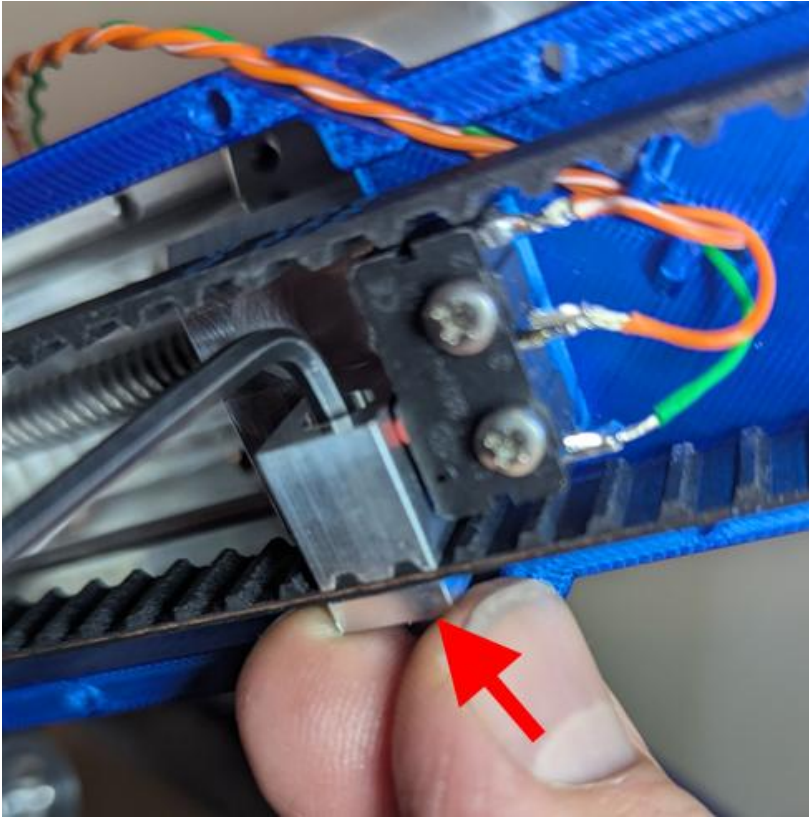

Make sure the hole drilled in belt is aligned with the J5 carrier and install (1) M3x8 cap screw through belt and threaded into J5 carrier clamp as shown (red arrow).

Make sure screw is tight and belt is secured to J5 carrier.

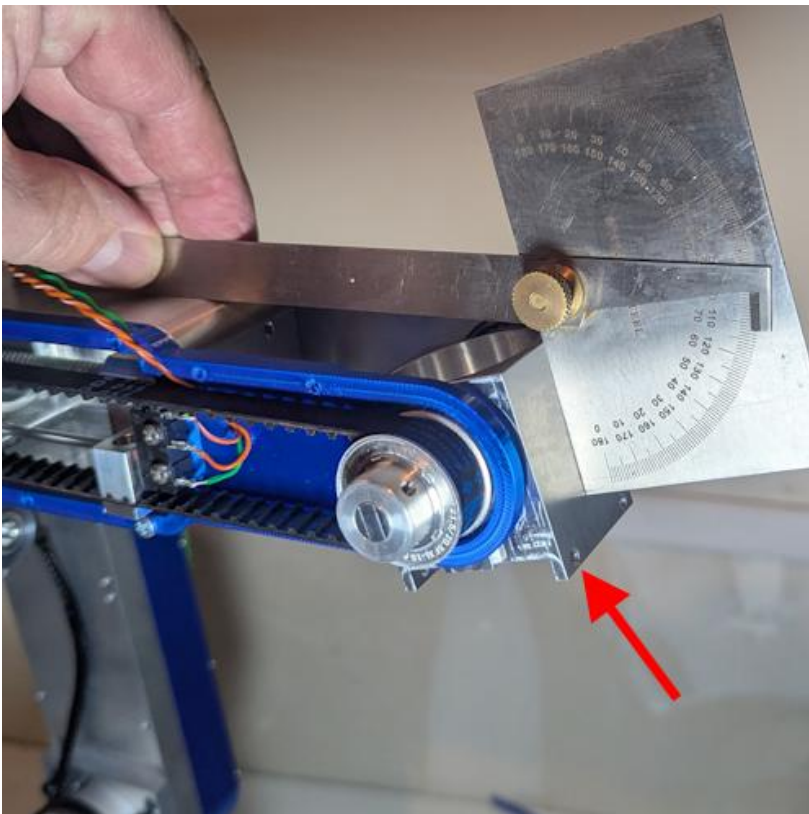

Given the pulley has not been secured to the J6 housing post the housing should still rotate freely.

Make sure the J5 carrier is in the forward position and that the limit switch has just clicked.

Rotate J6 housing to an up angle so that the motor side is down. (*note red arrow – motor mount screw hole is down*)

Use angle gauge placed across top of J5 housing - and set J6 housing angle to **105°** as shown.



With J6 housing at 105° install (2) M3x4 set screws into XL pulley then tighten both set screws.

The J5 angle is now mechanically calibrated to 105°.

This calibration can be fine tuned electronically after the robot has been connected to the software.

ALSO NOTE THAT IT IS IMPORTANT TO RE-CHECK THESE SCREWS AFTER A FEW HOURS OF OPERATION AND TIGHTEN IF NEEDED.

Use a 3mm drill to clear 12 holes in the J5 side spacer as indicated by the red arrows.

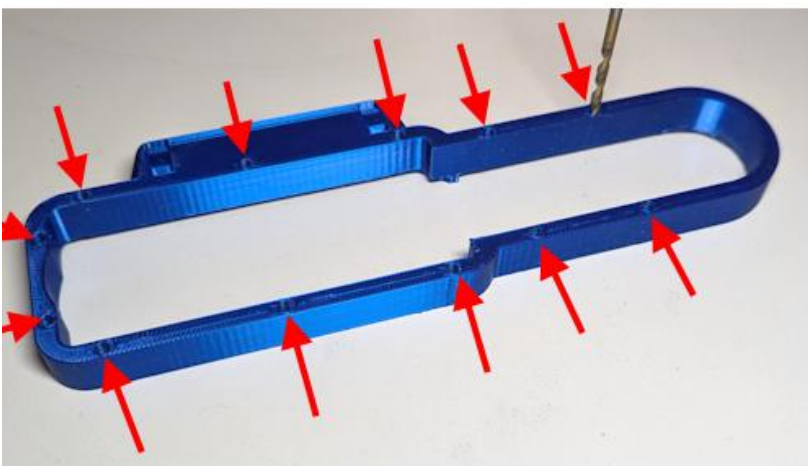



Install AR4 logo into recess in J5 side cap and secure with epoxy.

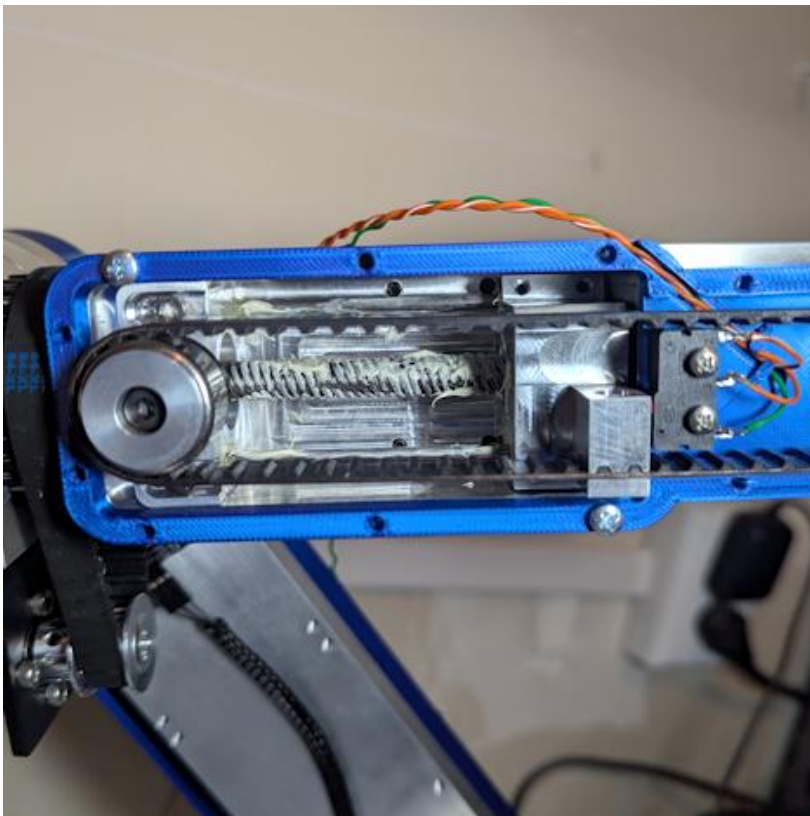

Apply small amount of grease to J5 lead screw and guide rods.



Install J5 side spacer and J5 side cap as shown and secure to J5 housing using (8) M3x25 Philips head pan screws (red arrows).



Install (4) M3x20 Philips pan head screws in front section of cap (red arrows) securing the side cover cap and side spacer to the side plate.

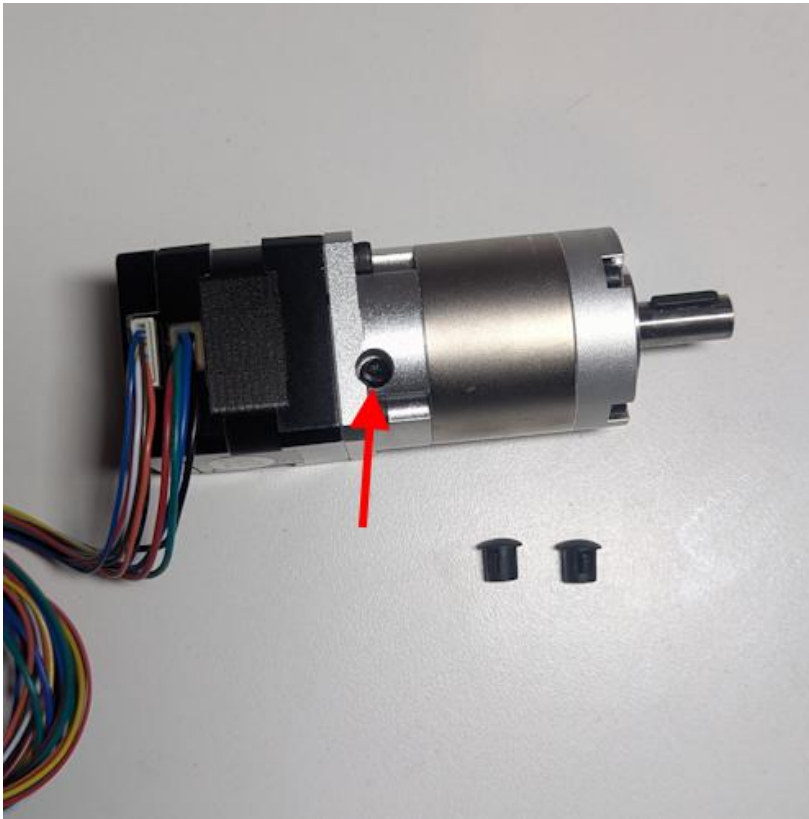

Remove the (2) plastic plugs from each side of the **14HS11-1004D-EGS20-AR4** - J6 motor gearbox.

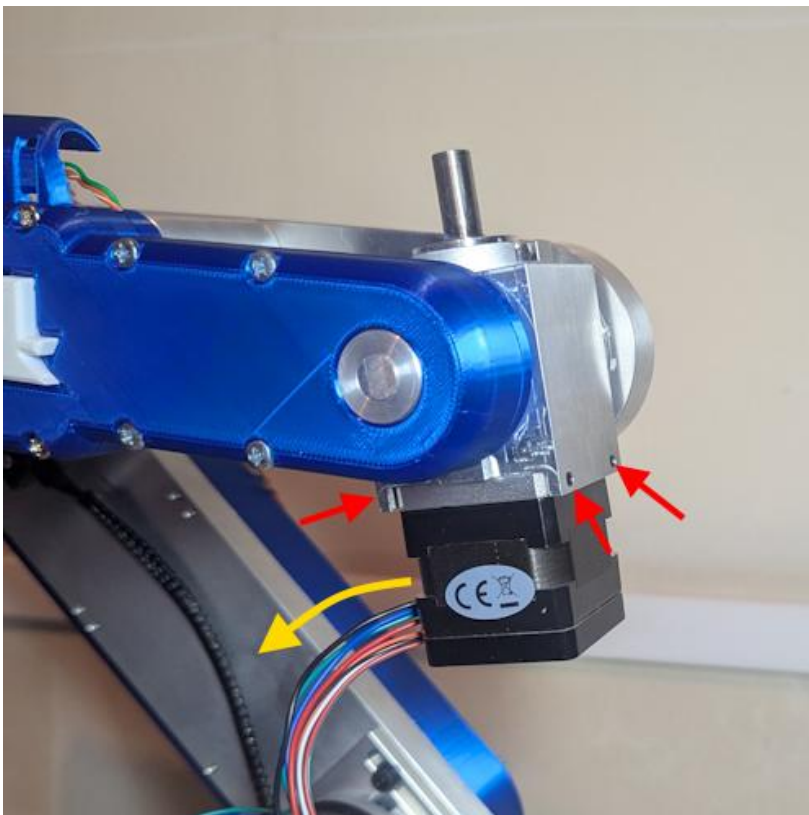

Install J6 motor into J6 housing as shown with wires facing back (yellow arrow).

Secure motor to housing using (4) M3x3 set screws. There are (2) in the front and (2) on the backside. (red arrows)

NOTE: MAKE SURE TO REMOVE GEARBOX DECAL AND ALL RESIDUE BEFORE INSTALLING MOTOR



For joint 4 cut length of continuous flex Cat6 cable to a length of 117cm long and remove outer jacket. (see overview section on jacket removal)



Remove 15cm of shielding from one end of the cable and remove 17cm of shielding from the other end. **(see overview section on removing shielding – be very careful not to cut or damage wires)**

The end with 15cm of shielding removed will be the end of the cable that is routed to the base enclosure.

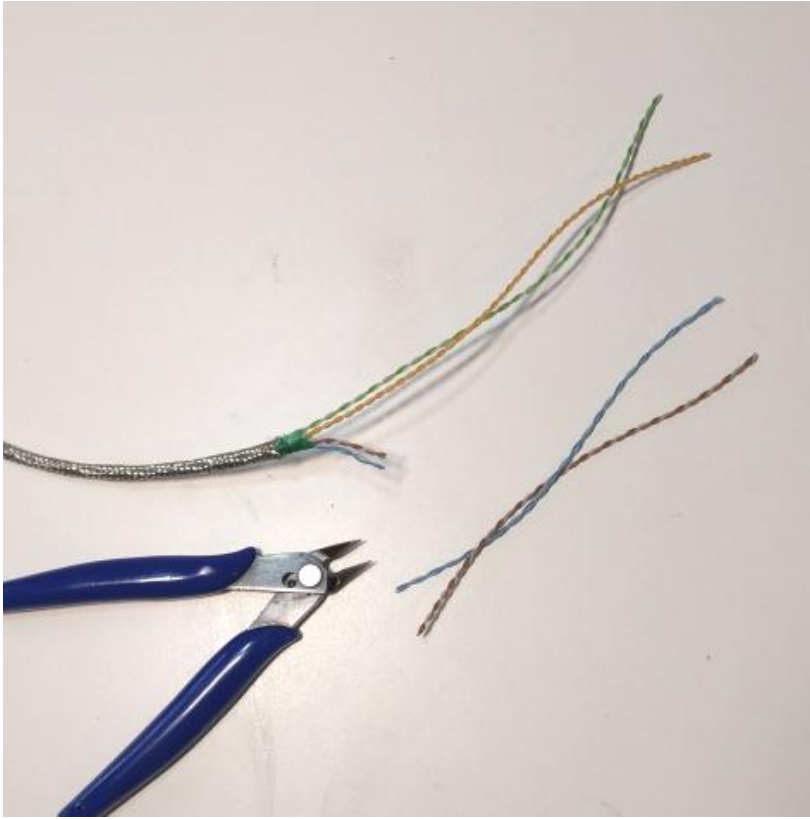

From the end of cable that has 17cm of shielding removed - cut and remove 14cm of the brown and blue twisted pairs leaving 3cm of wire exposed.



Cut length of $\frac{1}{4}$ " braided sleeve to a length of 15cm long then route green and orange twisted pairs through sleeve as shown.



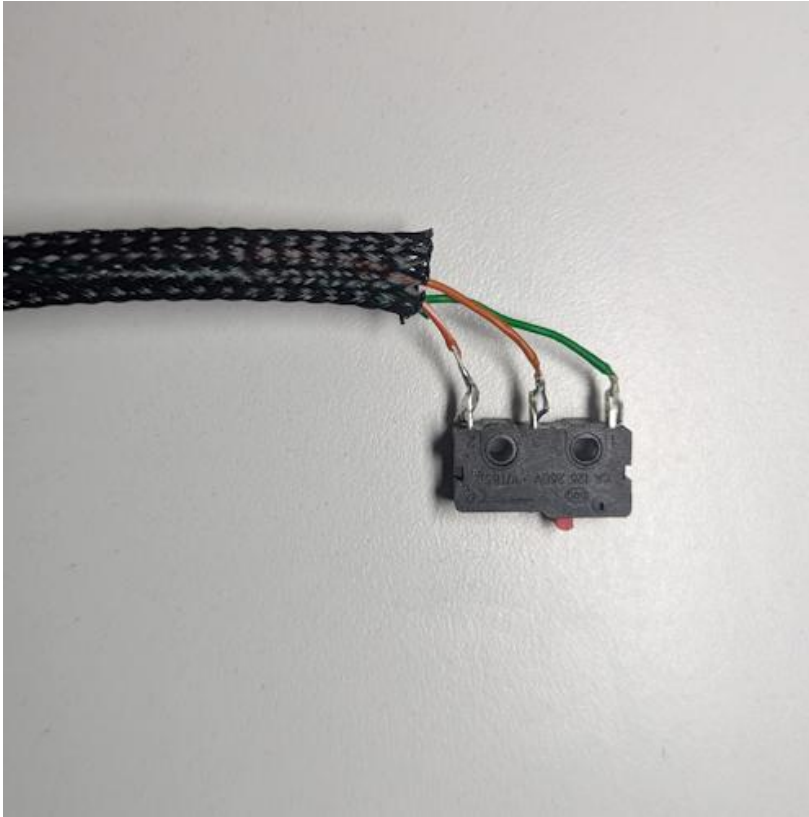

Solder orange wire to “NO” terminal of 10T85 limit switch.

Solder white with orange stripe wire to the “NC” terminal.

Solder the white with green stripe wire to the “C” terminal.

Note: the green wire is not used.

(also see wiring diagrams in chapter 4)



Insert J4 limit switch and connected wires into the J4 Limit Switch Motor Mount as shown.

Make sure soldered terminals and wires are recessed below the surface so there is no chance they will contact the aluminum housing in the next step. If needed you can insulate the terminals with liquid electrical tape.

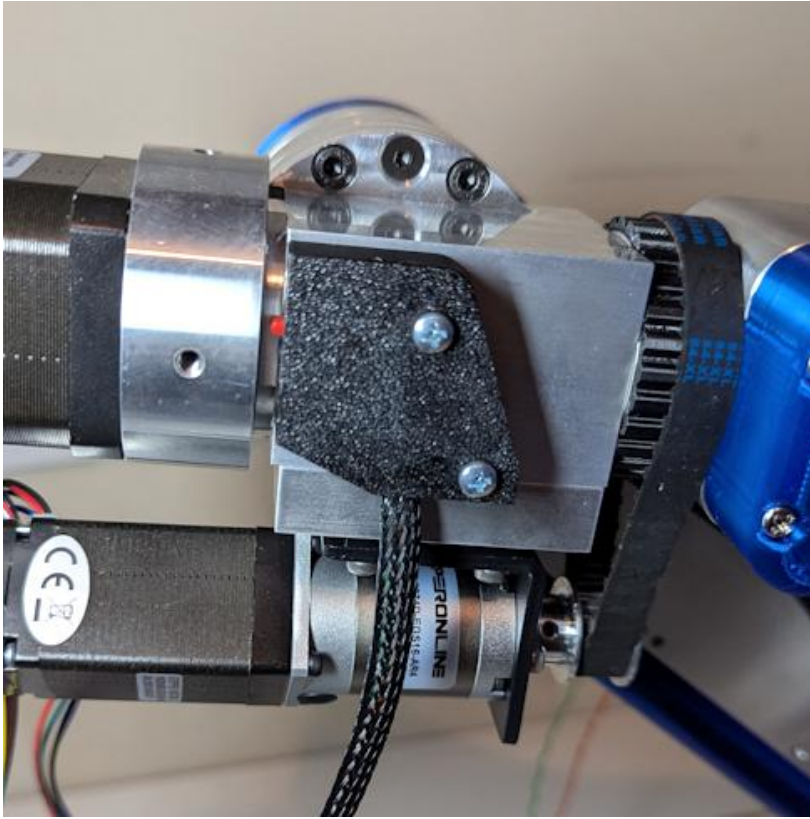

Use (2) M3x14 Philips pan head screws to secure switch mount to the J4 housing as shown in photo.

NOTE: When commissioning the robot don't forget to review the commissioning chapter – the J4 timing screw will need to be adjusted so that it correctly contact this limit switch.

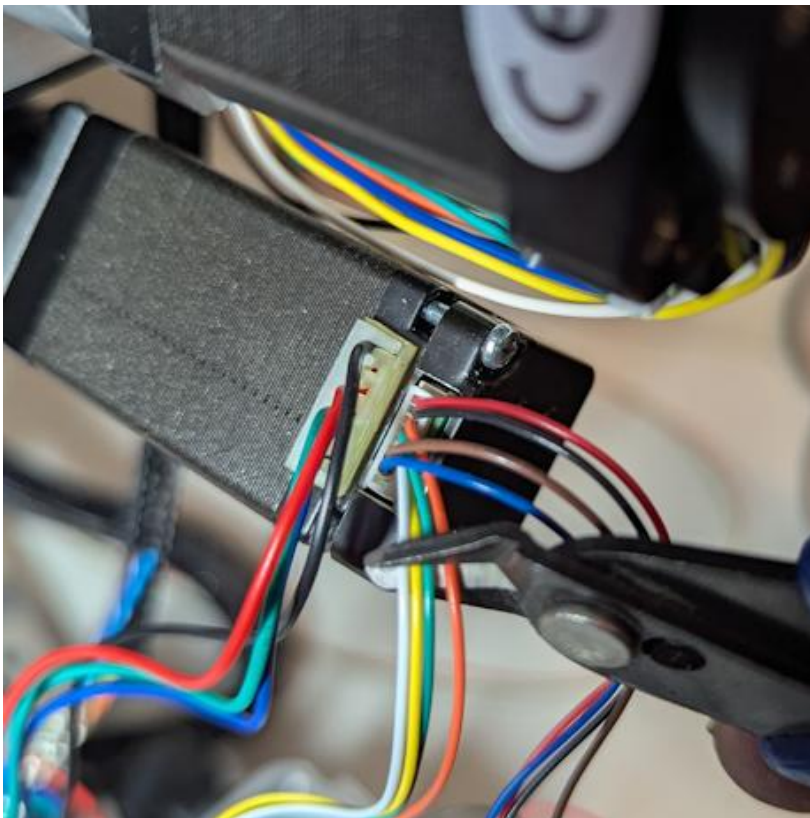

Trim the white, yellow, green and orange wires from the J4 encoder as shown. These wires will not be used.

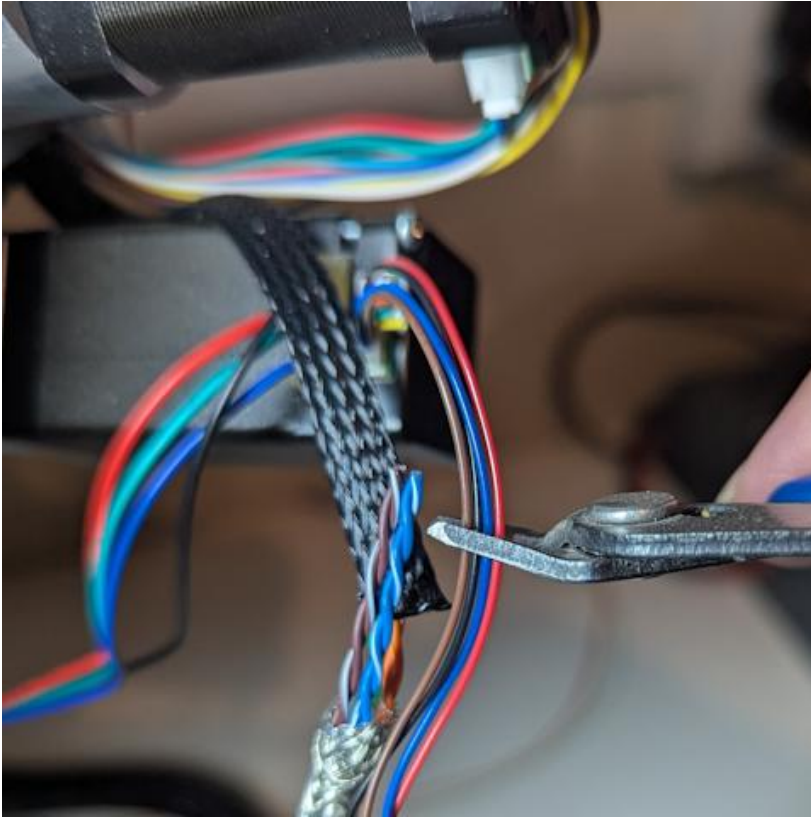

Trim the brown, black, blue and red encoder wires to a length of 4cm as shown.

NOTE: the length of the encoder wires will align with the brown and blue twisted pair that they will be connected to in the next step.

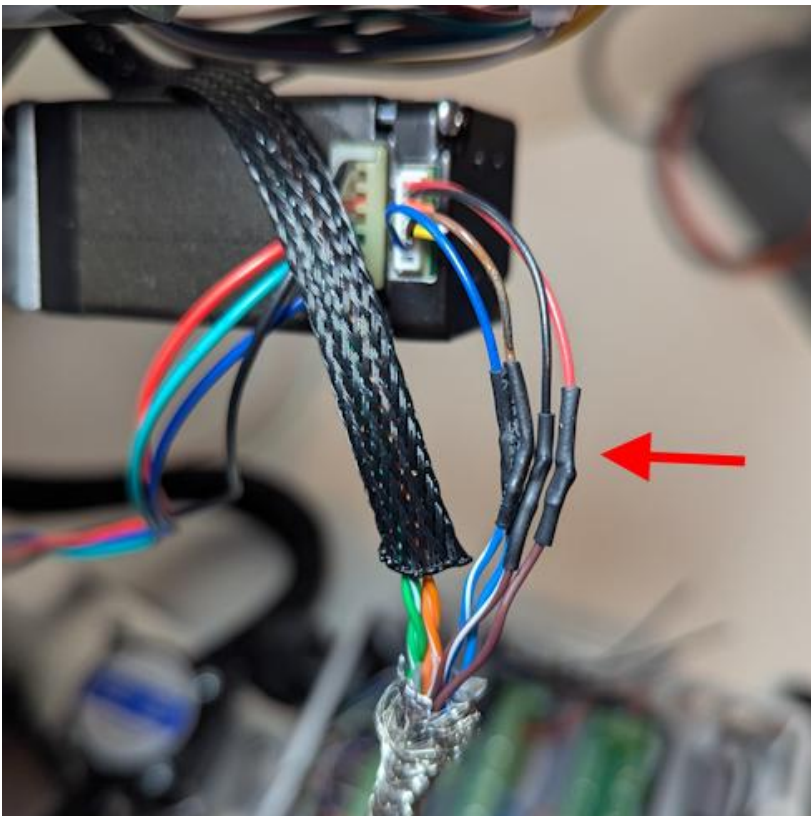

Solder and heat shrink the connection from the J4 encoder to the Cat6 cable as follows:

Encoder red wire to the cable brown wire.

Encoder black wire to the cable white – brown stripe wire.

Encoder brown wire to the cable white – blue stripe wire.

Encoder blue wire to the cable blue wire.



Cut Red, Black, Blue & Green 20awg wires to a length of 55cm long.

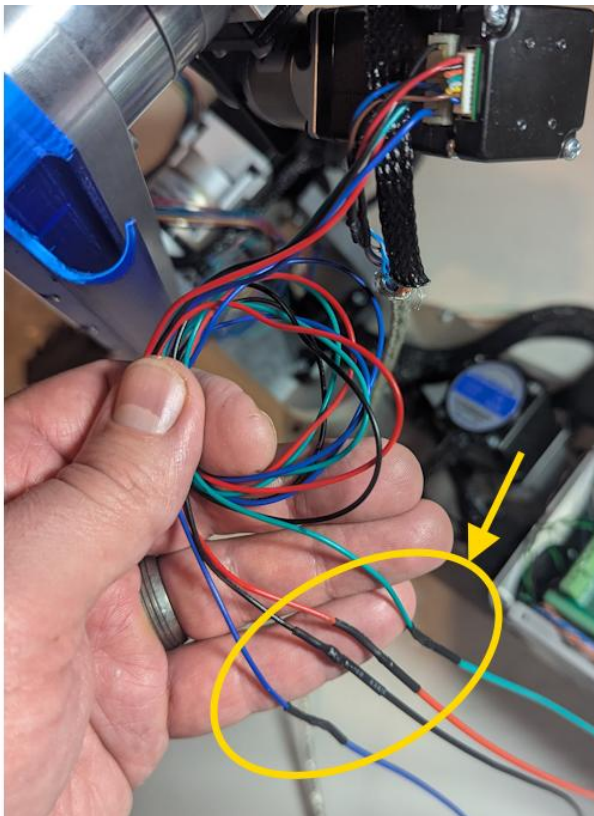

Solder and heat shrink 55cm long extension wires to the J4 motor wires as shown.

Be sure to match colors so that red goes to red and so on.

With the J4 motor wires extended the motor wires and Cat6 cable for J4 should now be the same length.

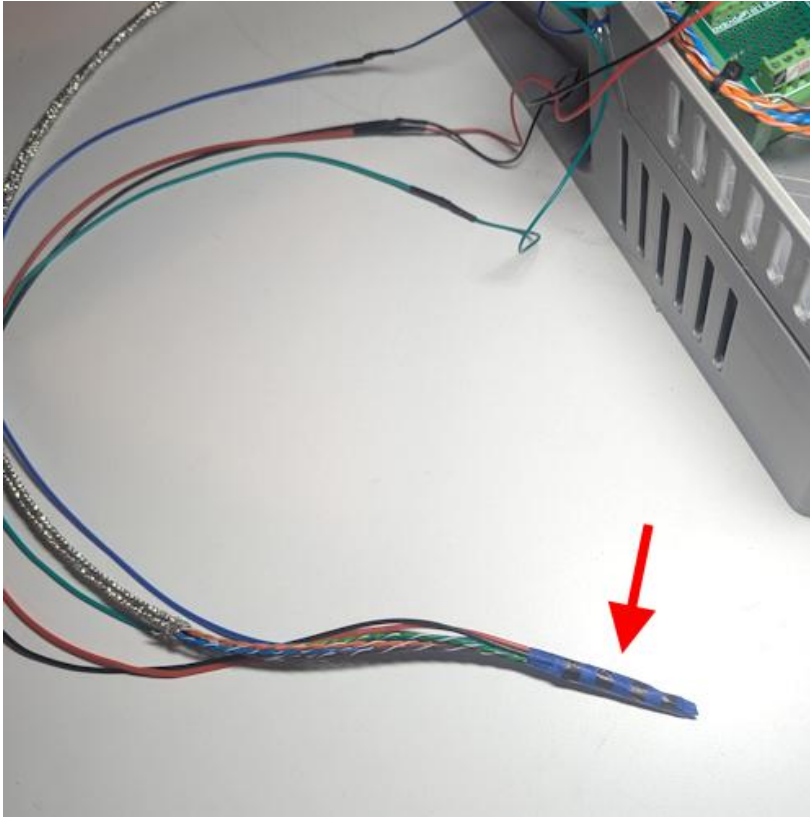

Wrap ends of J4 motor wires and J4 Cat6 cable with tape and then use a marker to put (4) stripes on each taped end so that you will know these are for J4 when wires have been routed inside enclosure

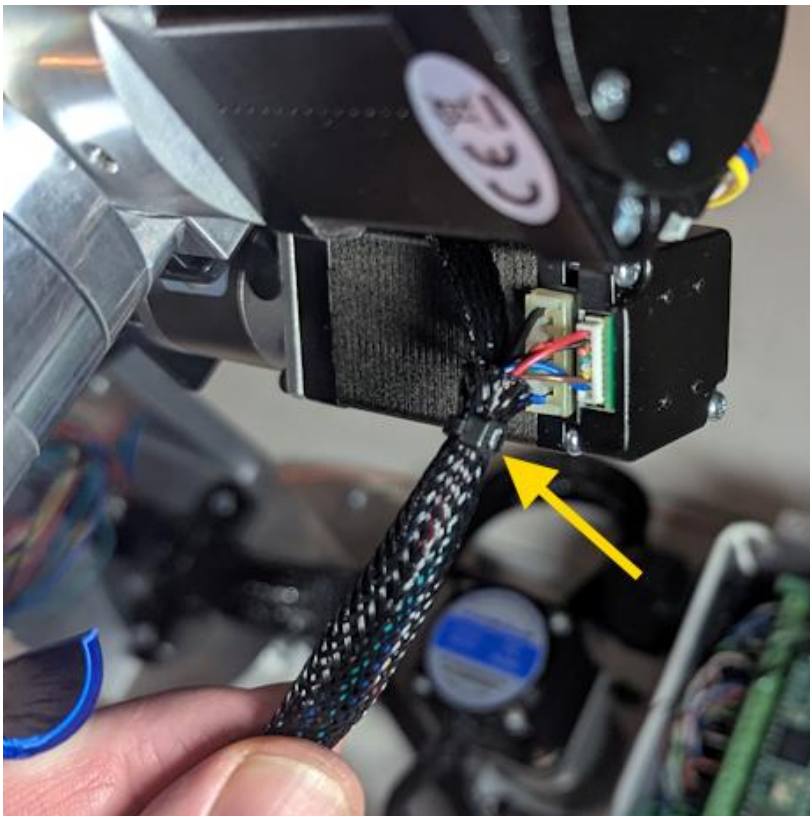

Cut length of ¼" braided sleeve to a length of 25cm long then route J4 motor wires and Cat6 cable through the sleeve.

This length of sleeve should slightly overlap the braided sleeve that goes to the J4 limit switch – use small cable tie to secure the braided sleeve where it overlaps the sleeve going to the limit switch (red arrow).



Route the J4 motor and cable wires into the J2 arm cable channel with the amount of arc and slack shown.

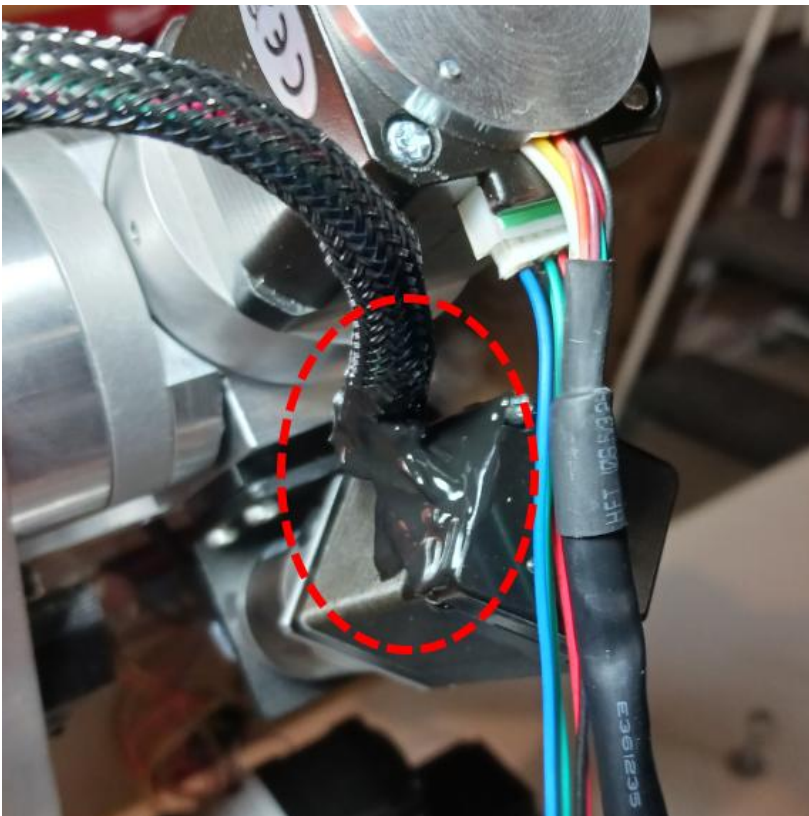

It is recommended to coat the exposed encoder and motor wires with liquid electrical tape at the base of the J4 motor as shown.

Make sure the cable arc length in the previous step is maintained and that the cable is not disturbed while the liquid electrical tape cures.

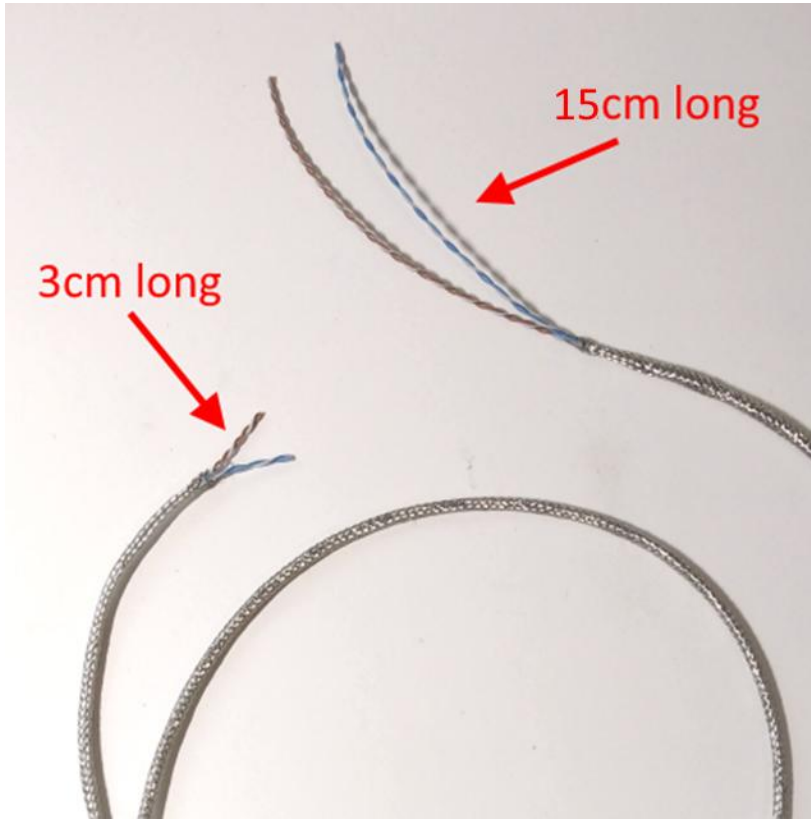

Using the 124cm brown and blue twisted pairs and shielding that was set aside earlier:

Cut wires and remove 10cm so they are 114cm long, also remove 10cm from the length of shielding – feed the brown and blue pairs through the shielding as shown - the wires should leave 15cm exposed from one end of the shielding and 3cm exposed from the other end of the shielding.

The end with 15cm of shielding removed will be the end of the cable that is routed to the base enclosure.

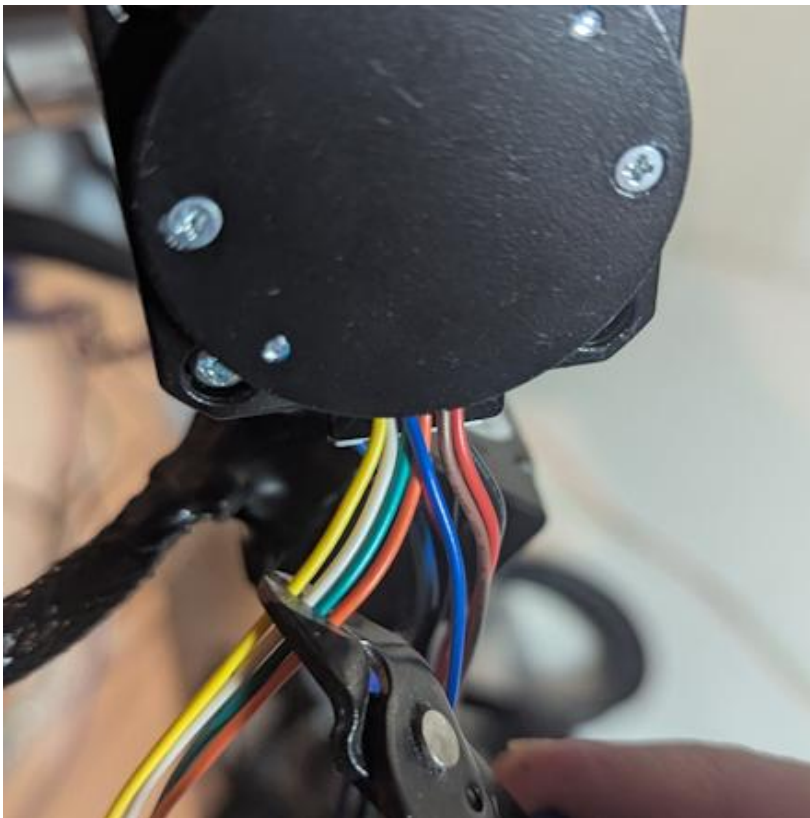

Trim the yellow, white, green and orange J5 encoder wires as shown, they will not be used.

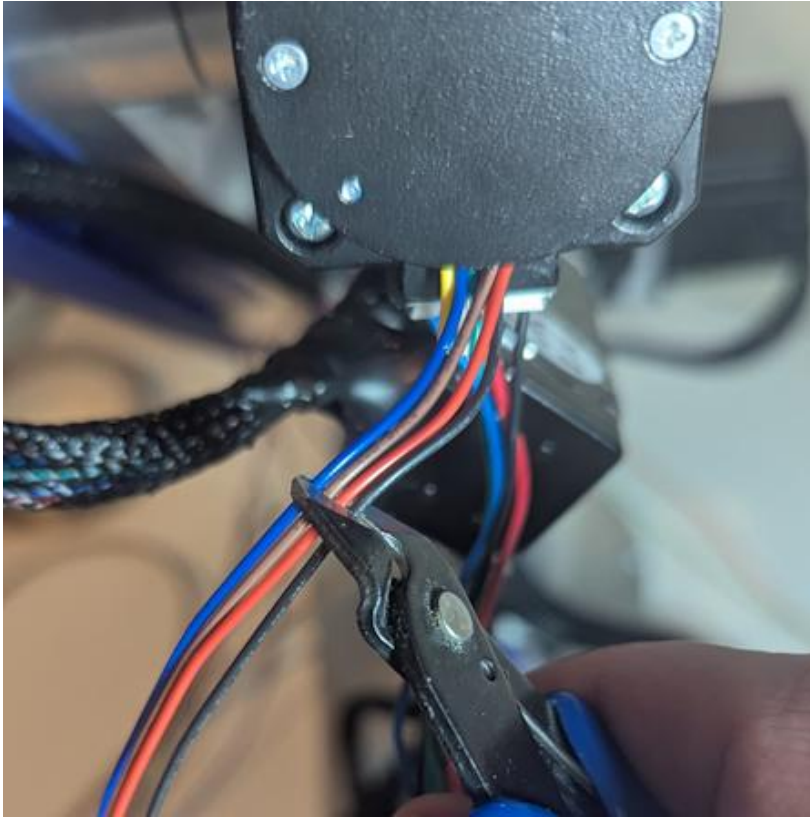

Trim the red, black, brown and blue J5 encoder wires to a length of 4cm.

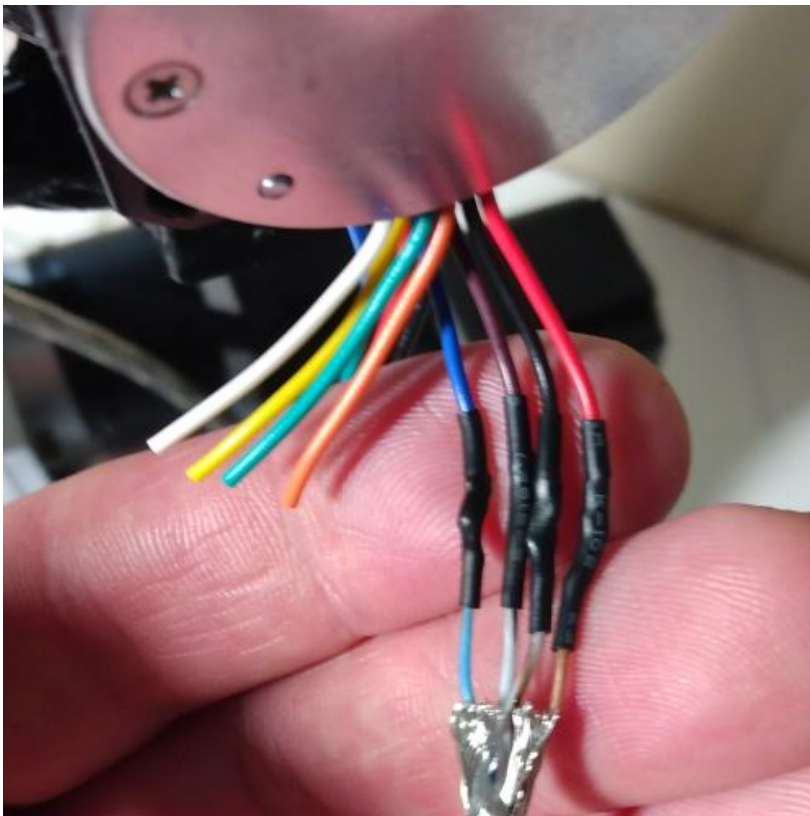

Solder and heat shrink the connection from the J5 encoder to the Cat6 cable as follows:

Encoder red wire to the cable brown wire.

Encoder black wire to the cable white – brown stripe wire.

Encoder brown wire to the cable white – blue stripe wire.

Encoder blue wire to the cable blue wire.

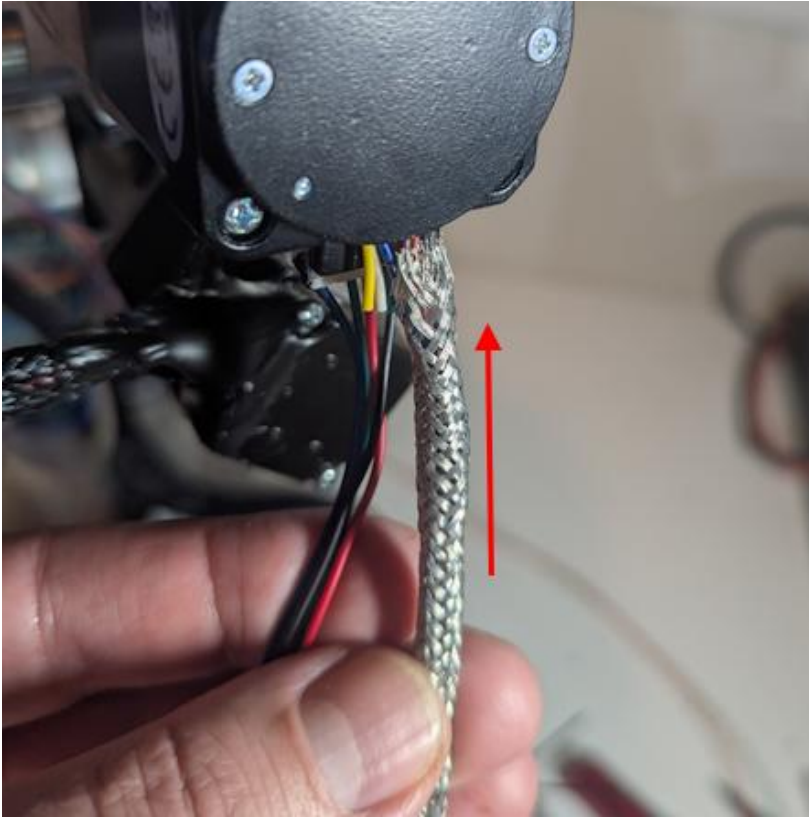

Slide the shielding up over the soldered connections as shown.



Cut Red, Black, Blue & Green 20awg wires to a length of 75cm long.



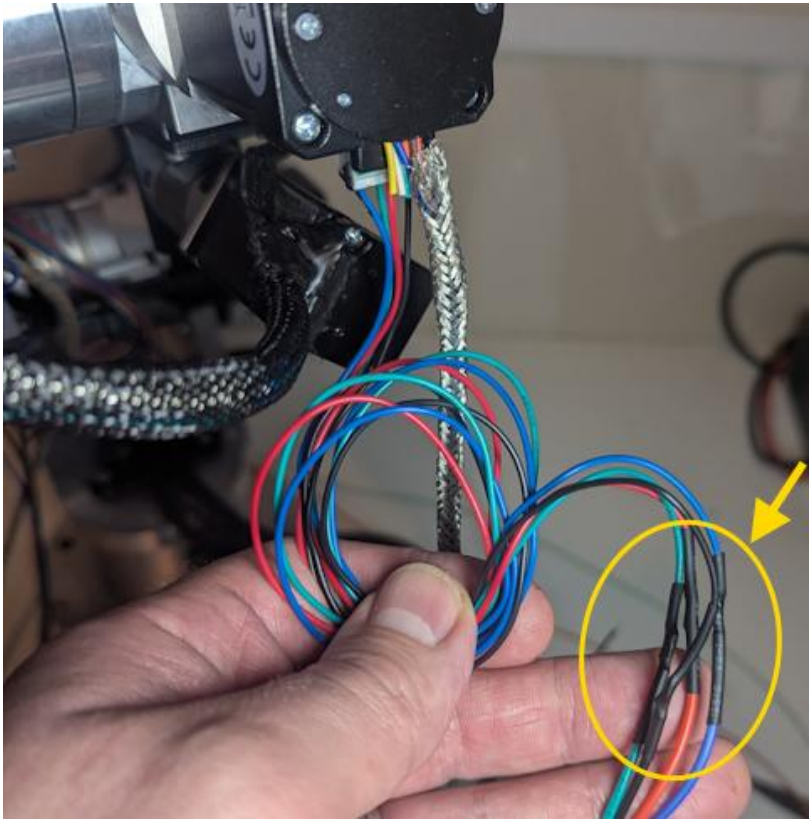

Solder and heat shrink 75cm long extension wires to the J5 motor wires as shown.

Be sure to match colors so that red goes to red and so on.

With the J5 motor wires extended the motor wires and Cat6 cable for J5 should now be the same length.

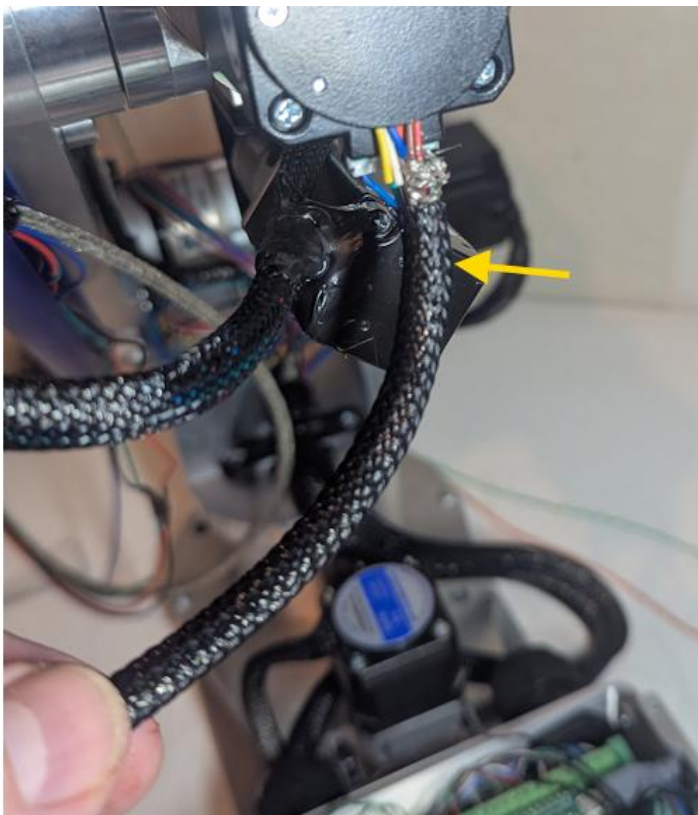

Cut length of 1/4" braided sleeve to a length of 33cm long then route J5 motor wires and Cat6 cable through the sleeve.



Secure the 3D printed J5 motor bracket to the J5 motor housing using a large cable tie as shown.

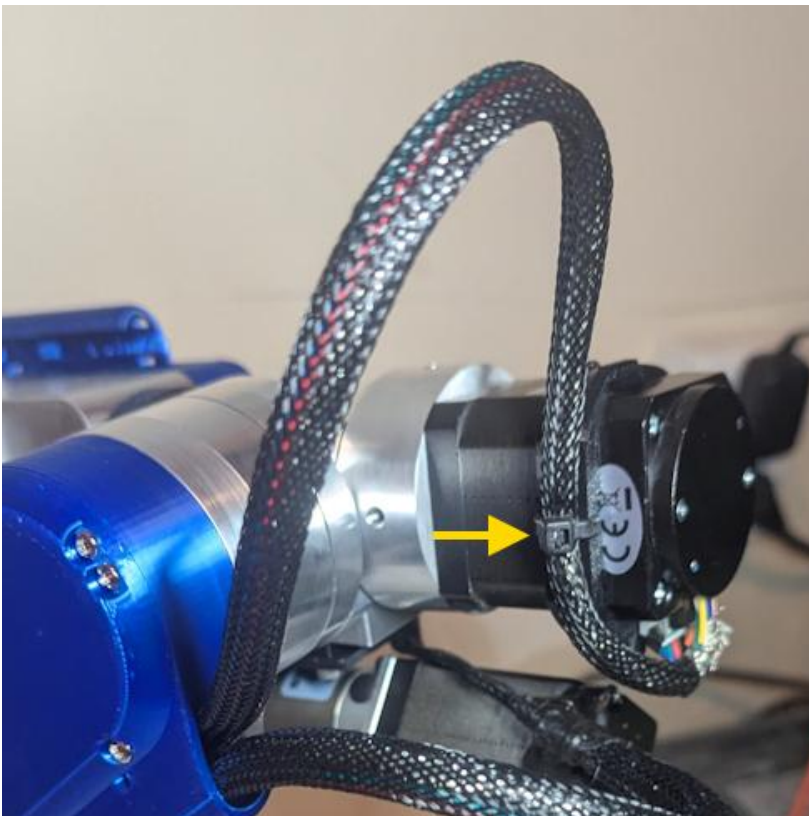

Route the J5 motor and cable wires into the J2 arm cable channel with the amount of arc and slack shown.

Secure J5 wires and cable to the motor bracket with a small cable tie where shown (yellow arrow)

NOTE: the slack or amount of arc in the cable must leave enough room that J4 can fully articulate without pulling the cable.

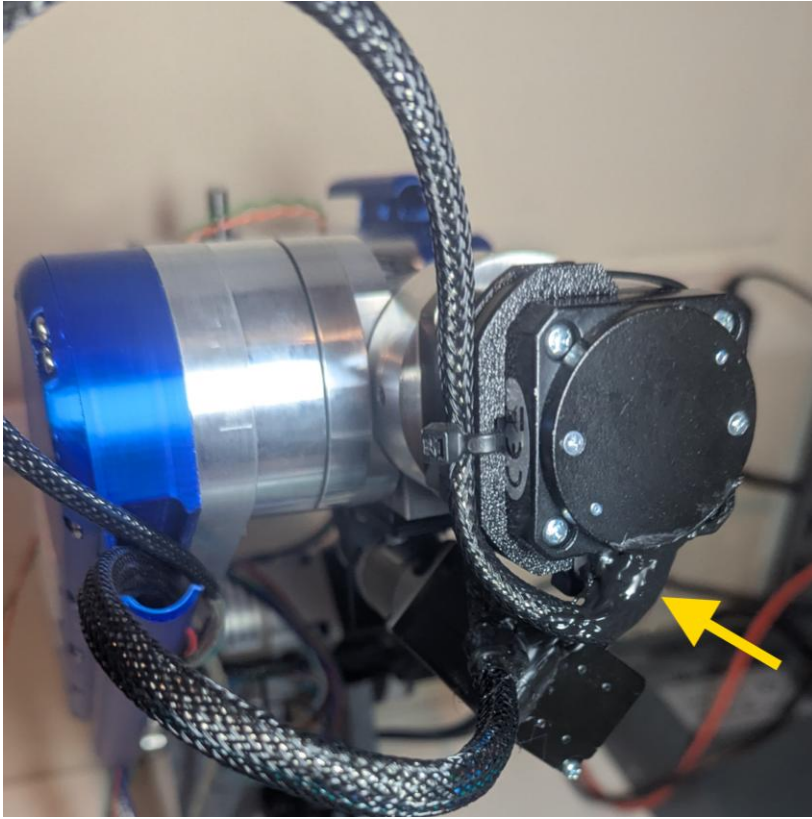

It is recommended to coat the exposed encoder and motor wires with liquid electrical tape (yellow arrow).

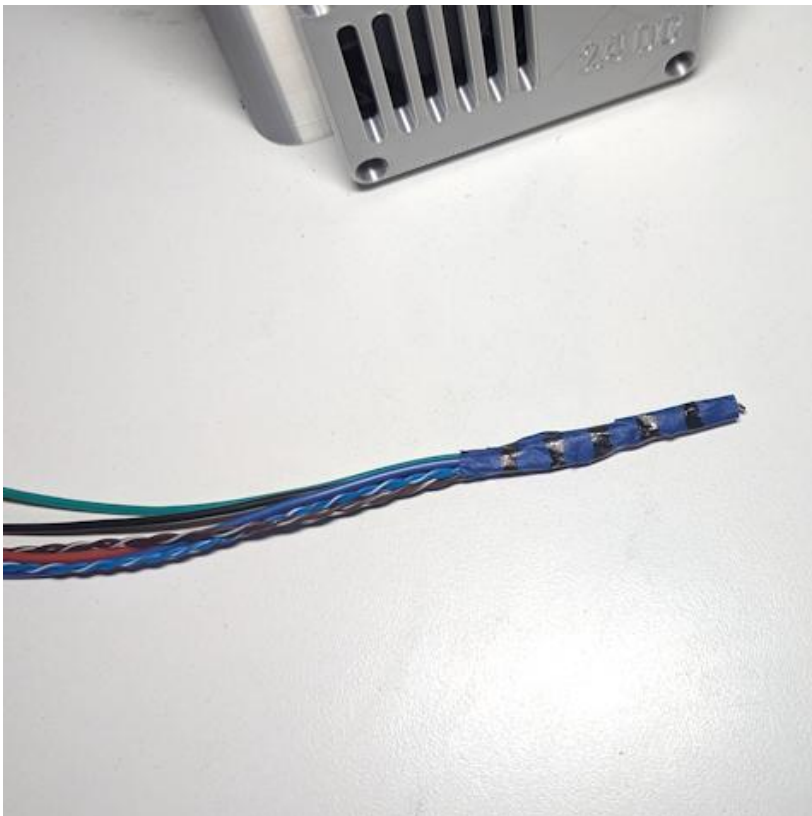

Wrap ends of J5 motor wires and encoder wires with tape and then use a marker to put (5) stripes on the taped end.



For joint 6 cut a length of continuous flex Cat6 cable to a length of 151cm long and remove outer jacket. (see overview section on jacket removal)

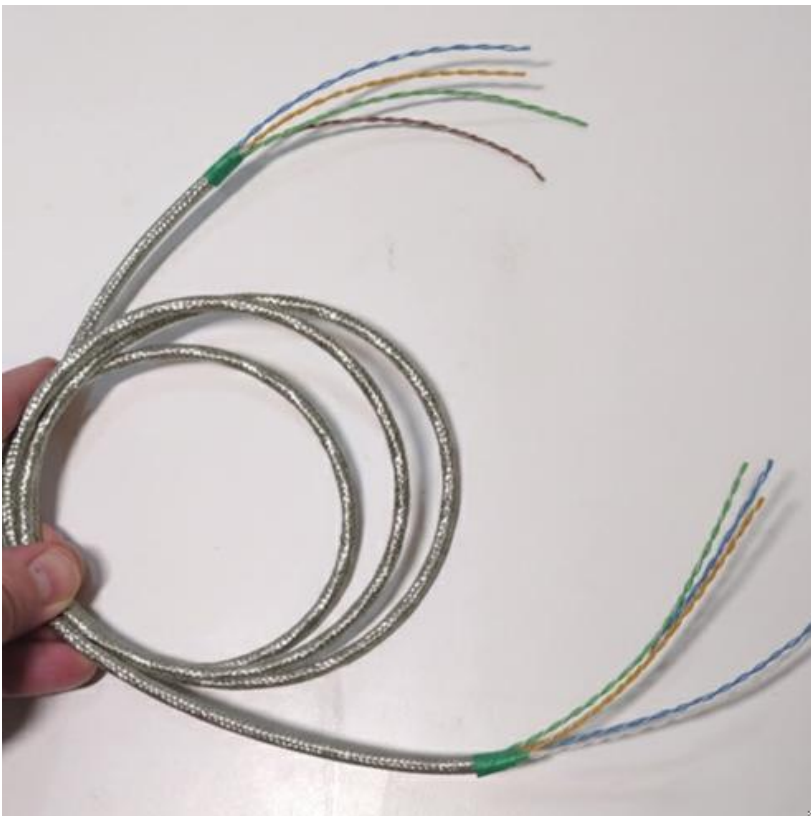

Remove 15cm of shielding from one end of the cable and remove 14cm of shielding from the other end. **(see overview section on removing shielding – be very careful not to cut or damage wires)**

The end with 15cm of shielding removed will be the end of the cable that is routed to the base enclosure.

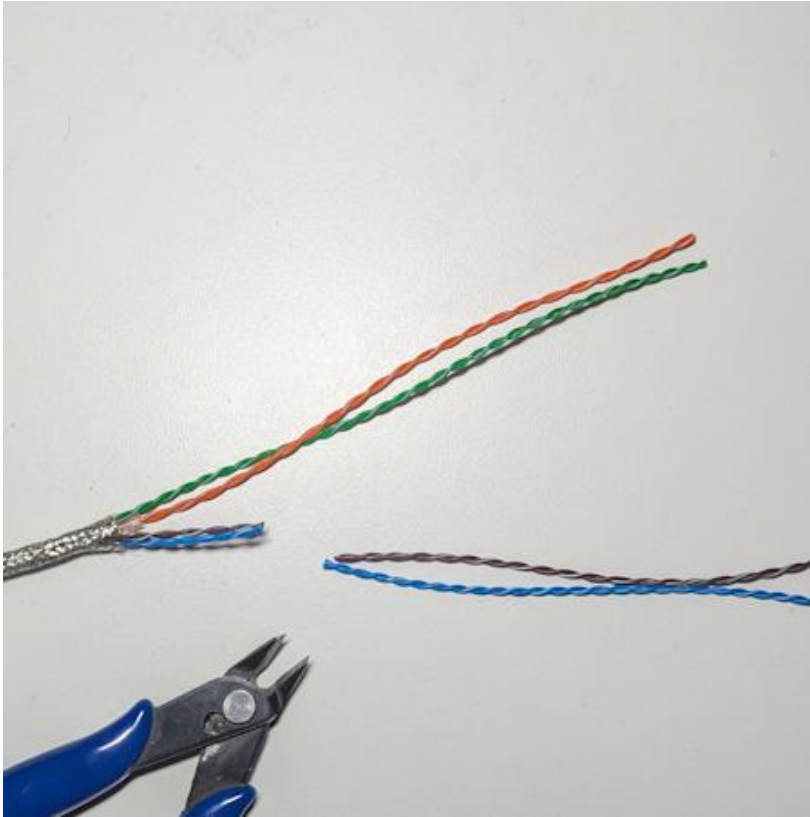

From the end of cable that has 14cm of shielding removed - cut and remove 11cm of the brown and blue twisted pairs leaving 3cm of wire exposed.

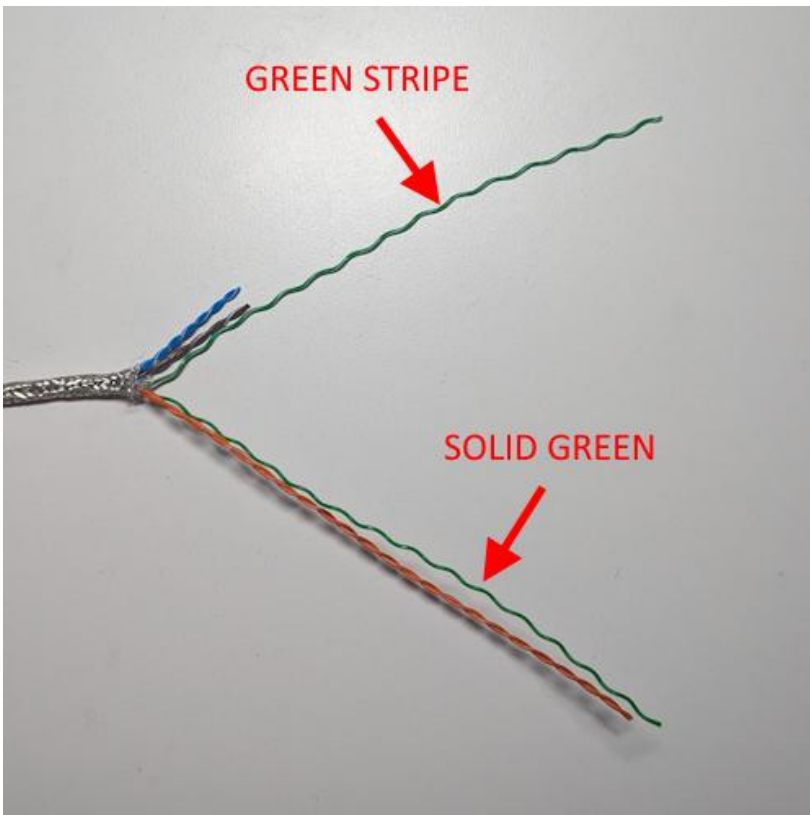

Untwist the green pair and separate the wires so that the green - stripe wire stays along side the brown and blue twisted pairs.

The solid green wire should stay along side the orange twisted pair.

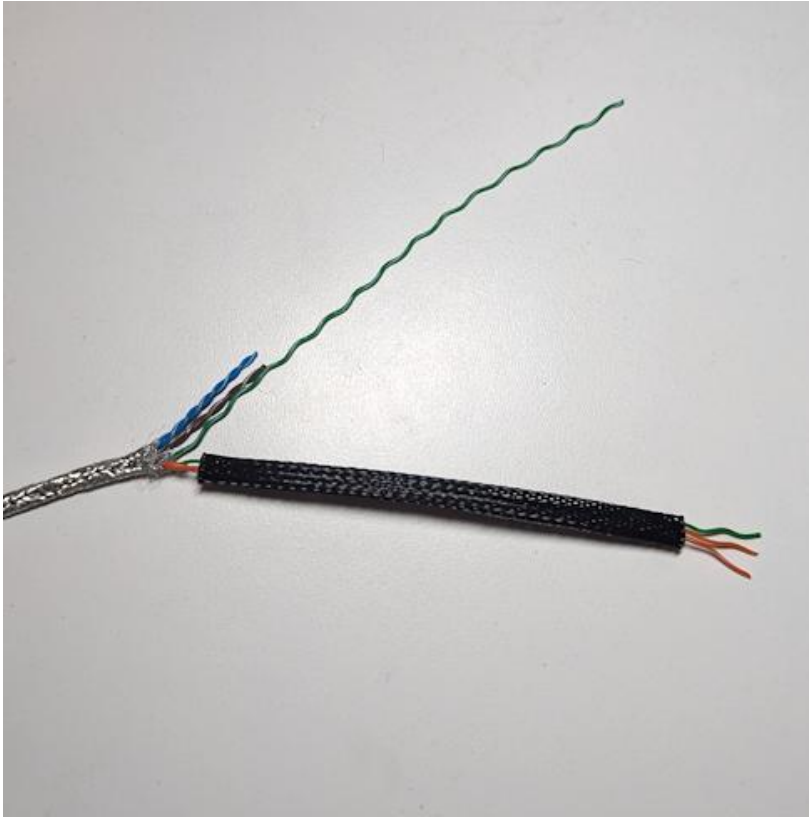

Cut length of ¼" braided sleeve to a length of 12cm

Route orange twisted pair and solid green wire through the braided sleeve.

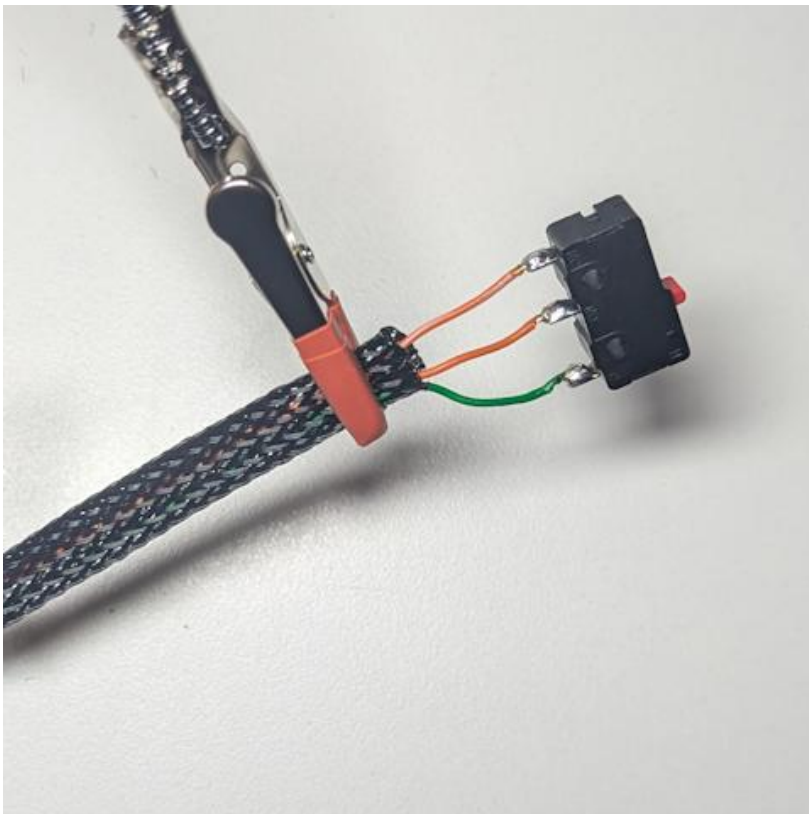

Solder orange wire to "NO" terminal of 10T85 limit switch.

Solder white with orange stripe wire to the "NC" terminal.

Solder the green wire to the "C" terminal.

(also see wiring diagrams in chapter 4)

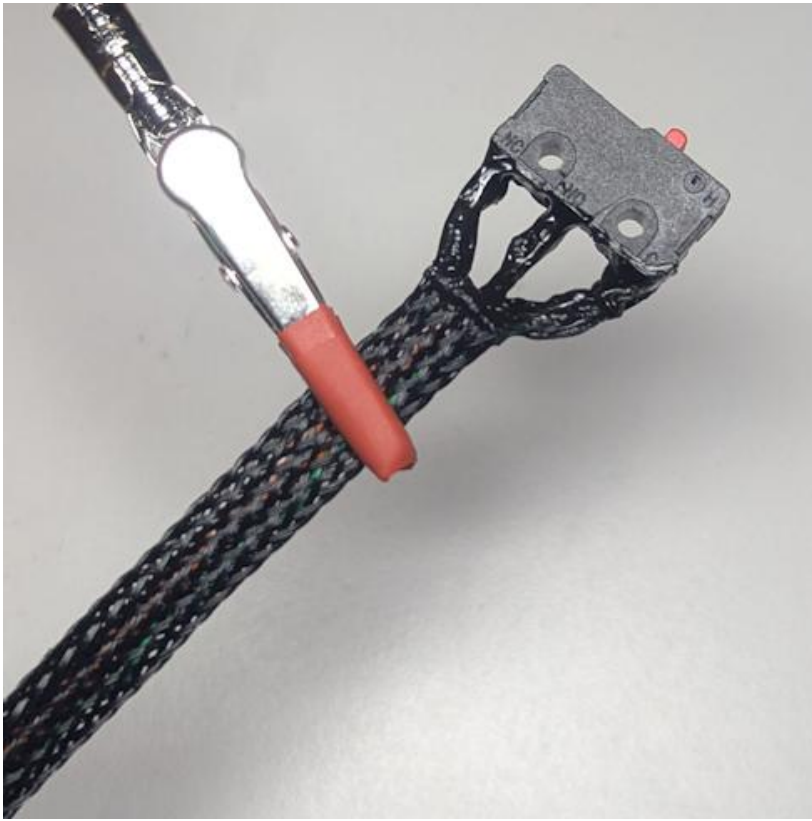

Coat switch terminals with liquid electrical tape as shown.

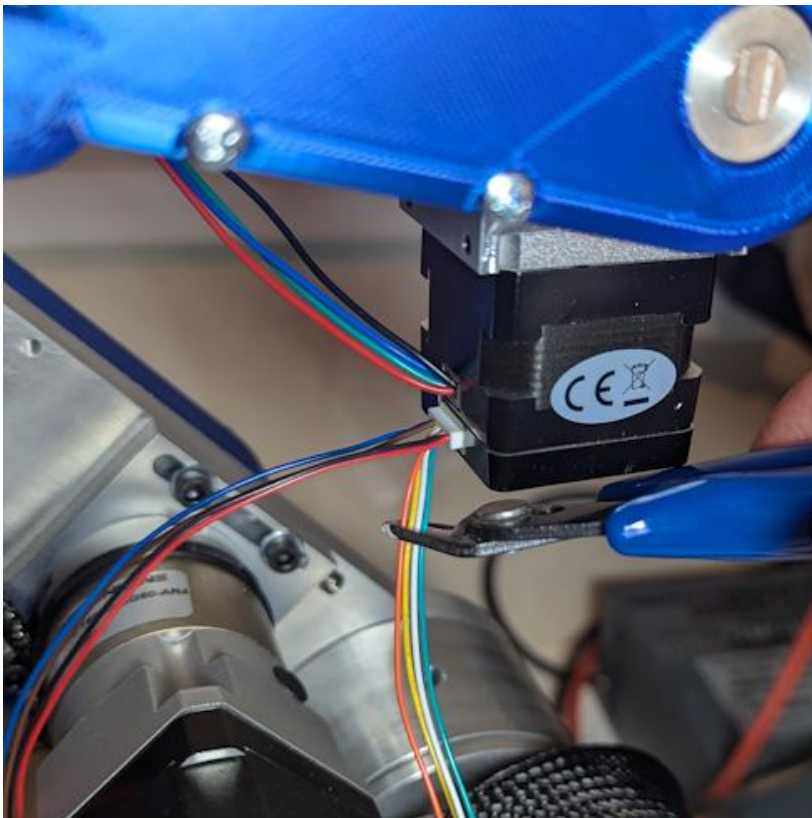

Trim the orange, yellow, white and green encoder wires from the J6 motor as shown.

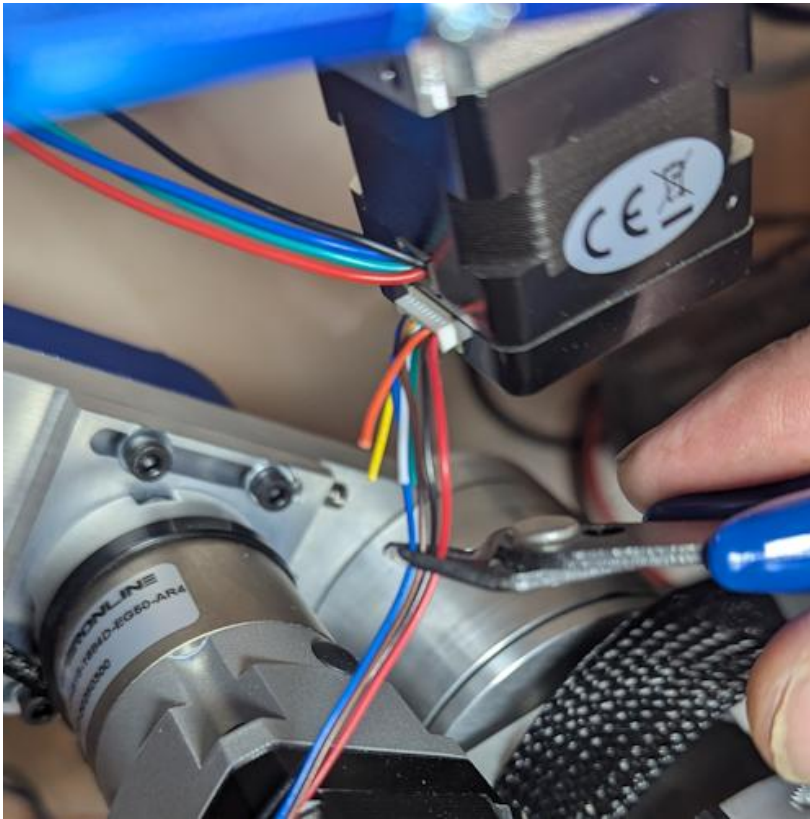

Trim the J6 motor wires to a length of 3cm as shown.

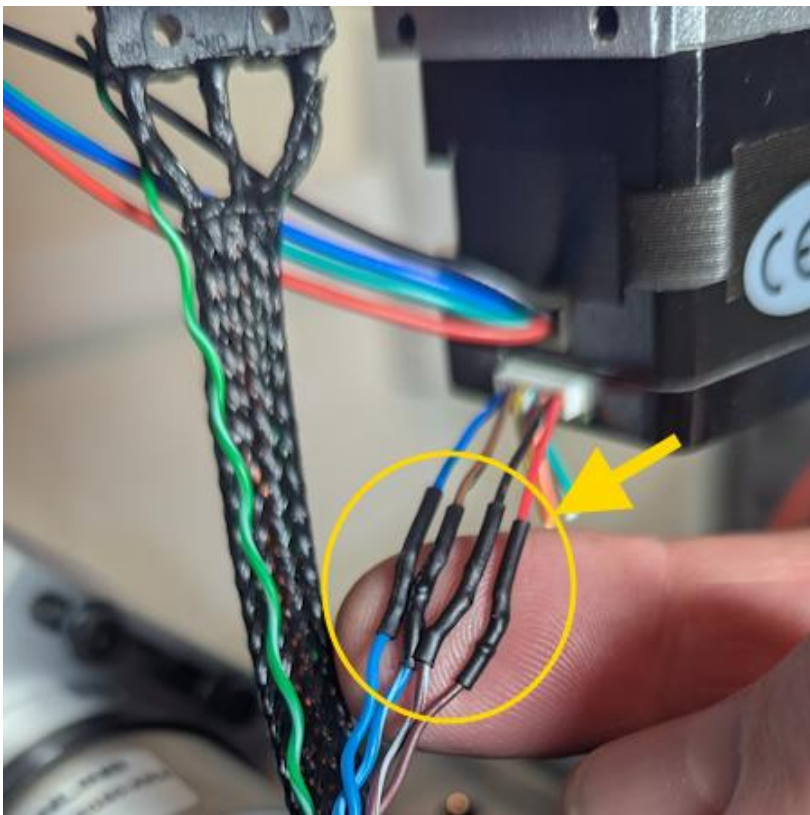

Solder and heat shrink the connection from the J6 encoder to the Cat5 cable as follows:

Encoder red wire to the cable brown wire.

Encoder black wire to the cable white – brown stripe wire.

Encoder brown wire to the cable white – blue stripe wire.

Encoder blue wire to the cable blue wire.

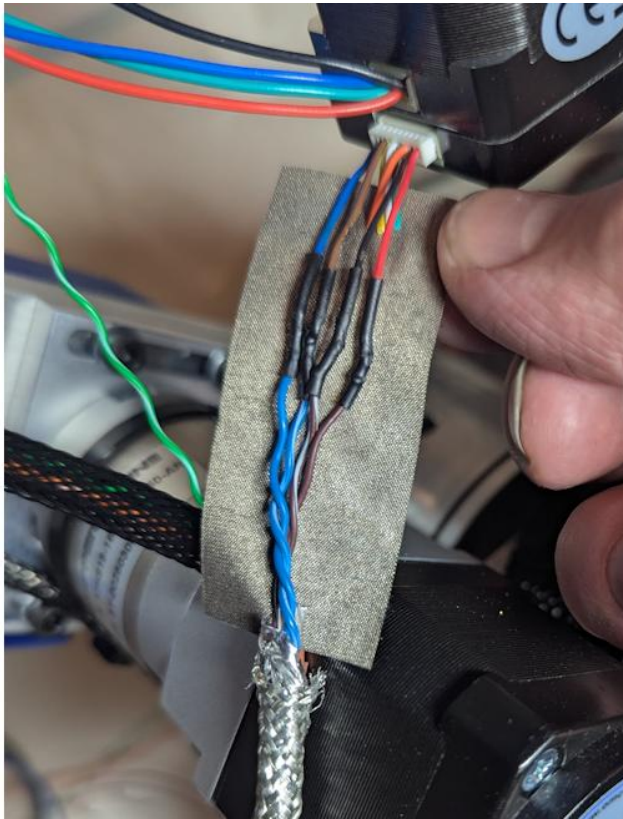

Remove adhesive back from 5cm length of EMI shielding tape and apply to the J6 encoder wires as shown.



Wrap EMI shielding tape as shown.



Cut Red, Black, Blue & Green 20awg wires to a length of 100cm long.

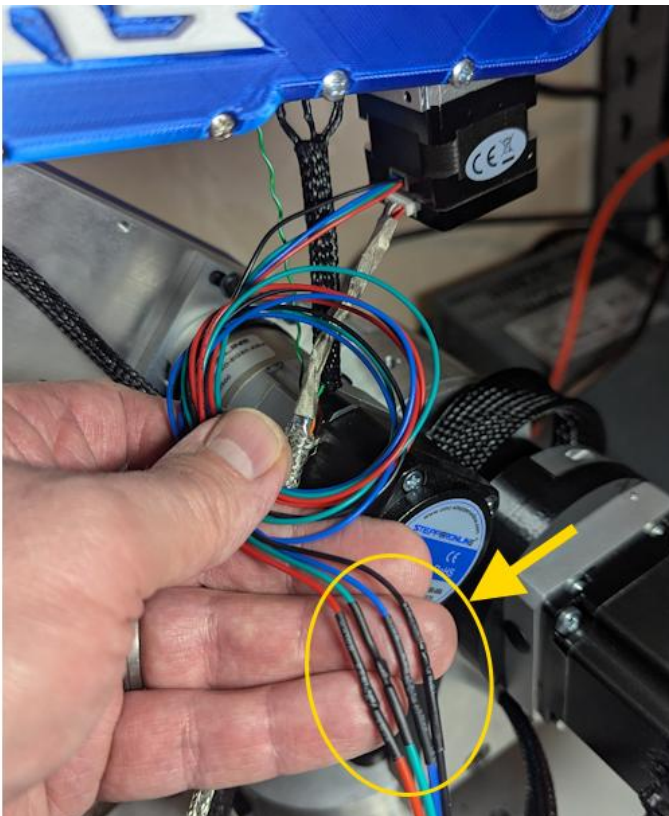

Solder and heat shrink 100cm long extension wires to the J6 motor wires as shown.

Be sure to match colors so that red goes to red and so on.

With the J6 motor wires extended the motor wires and Cat6 cable for J6 should now be the same length.



- ▶ Wrap ends of J6 motor wires and J6 Cat6 cable with tape and then use a marker to put (6) stripes on each taped end so that you will know these are for J6 when wires have been routed inside enclosure.

AT THIS POINT IN THE ASSEMBLY, WE NEED TO INCLUDE WIRES OR PNEUMATIC TUBING FOR ANY GRIPPER YOU WISH TO INSTALL ON THE ROBOT. PLEASE REVIEW CHAPTERS 3 AND 4 TO SEE ALL THE COMPONENTS NEEDED FOR EACH TYPE OF GRIPPER.



If you wish to install a Servo gripper you will need red and black 20awg silicone jacket wire 162cm long – also see chapter on servo gripper



If you wish to install a Pneumatic gripper you will need (2) lengths of 4mm silicone tubing – also see chapter on pneumatic gripper

SERVO GRIPPER OPTION



If installing a **Servo gripper** route the 100cm 20awg red and black wires along with the J6 CAT5 cable and motor wires (yellow arrow)

The ends of the servo gripper power wires should align or end at the same length or position of the CAT5 green stripe wire as shown (red arrow)

PNEUMATIC GRIPPER OPTION



If installing a **Pneumatic gripper** route the silicone tubing along with the J6 CAT5 cable and motor wires (yellow arrow)

The ends of the tubing should extend 20cm beyond the J6 motor as shown in photo (red arrow)

THE REMAINDER OF THIS CHAPTER FOR THE ROBOT ARM ASSEMBLY WILL SHOW THE SERVO GRIPPER OPTION WITH THE 20awg SILICONE WIRES.

IF YOU ARE INSTALLING A PNEUMATIC GRIPPER, PLEASE REFER TO CHAPTER 4 FOR THE FINAL DETAILS ON THE PNEUMATIC GRIPPER OPTION.

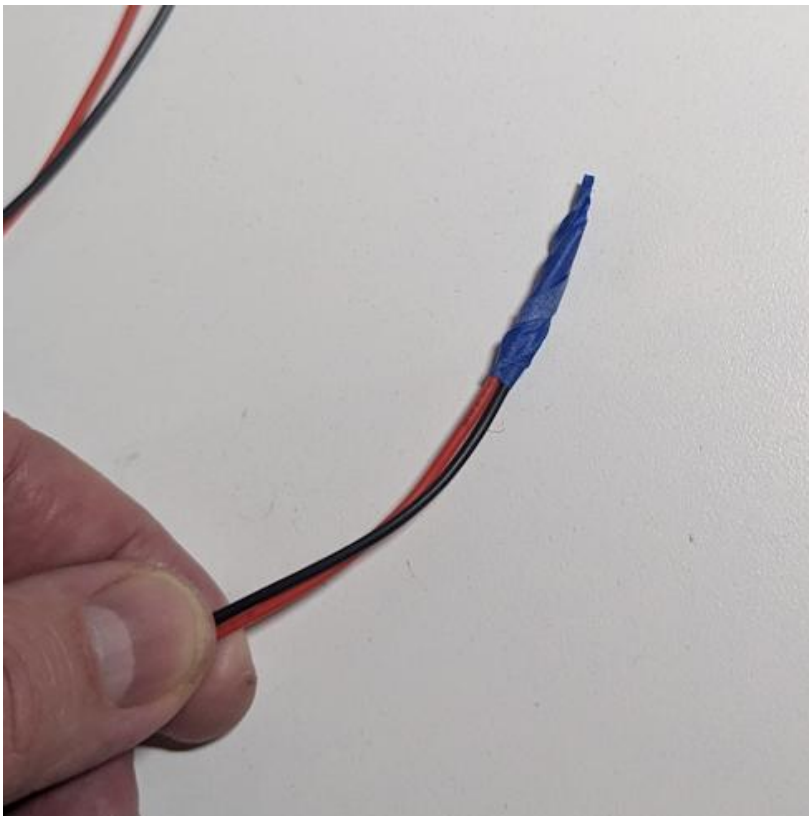

Wrap the opposite ends of the 20awg servo gripper power wires with tape to make it easier to feed these wires along with the J6 cable and motor wires through braided sleeve shown in future steps.



Cut length of 1/4" braided sleeve to a length of 24cm long then route J6 motor wires, encoder wires, as well as pneumatic tube or gripper power wires through the sleeve (red arrow).

Braided sleeve should slightly overlap the limit switch braided sleeve as shown in photo (yellow arrow)



Route J6 cable/wires and sleeve through upper arm as shown.

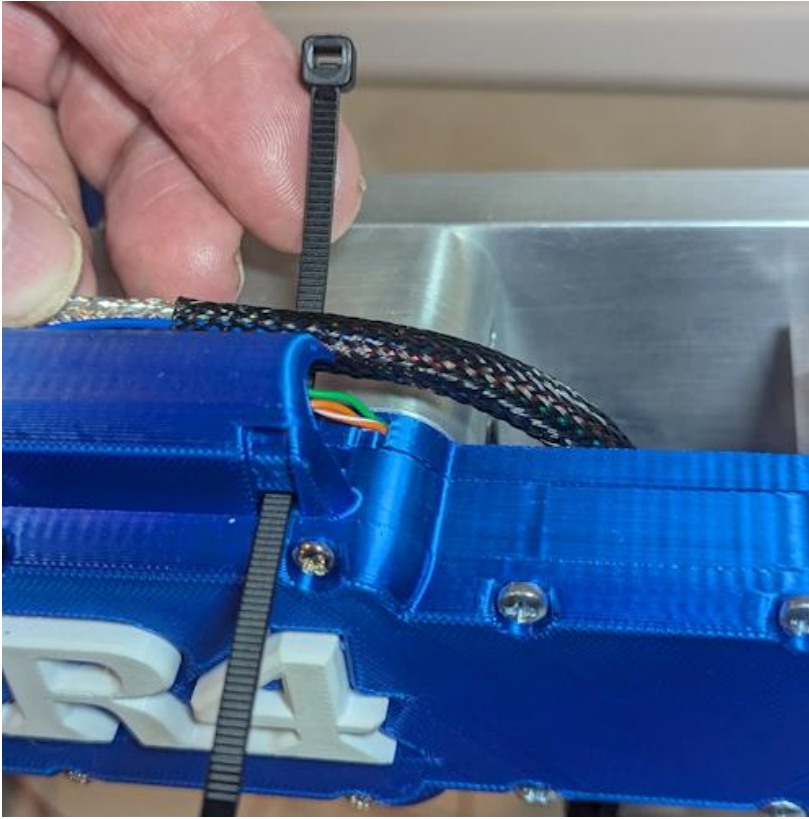

Insert small cable tie under the J6 cable/wires also under the J5 orange and green limit switch wires as shown. Cable tie should extend through the lower slot in the J5 side spacer.

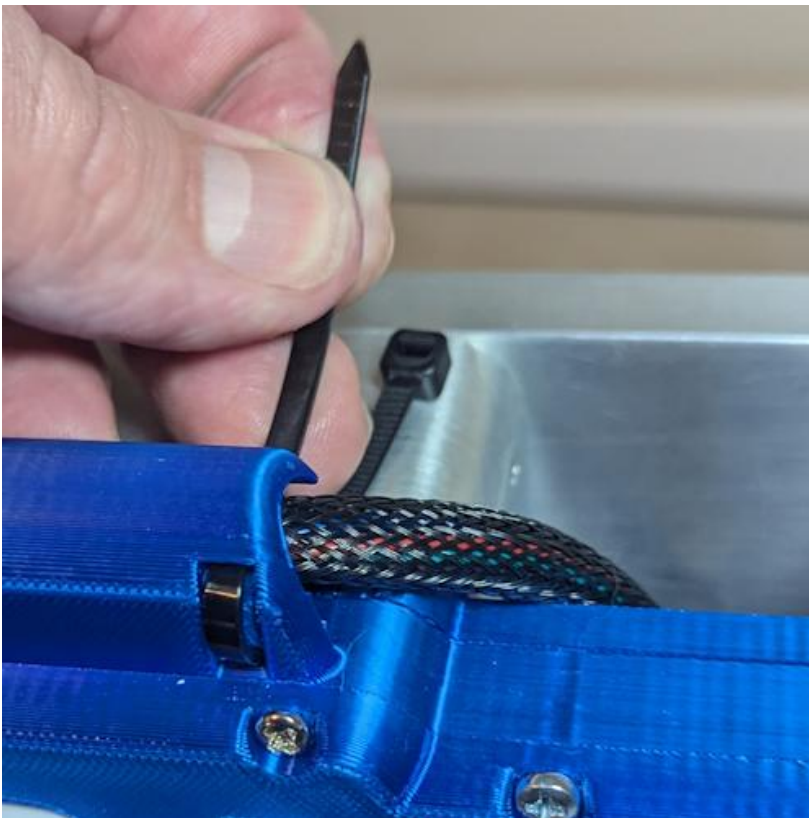

Feed end of cable tie through upper slot in J5 side spacer and over the top of the J6 wires/cable & J5 limit switch wires.

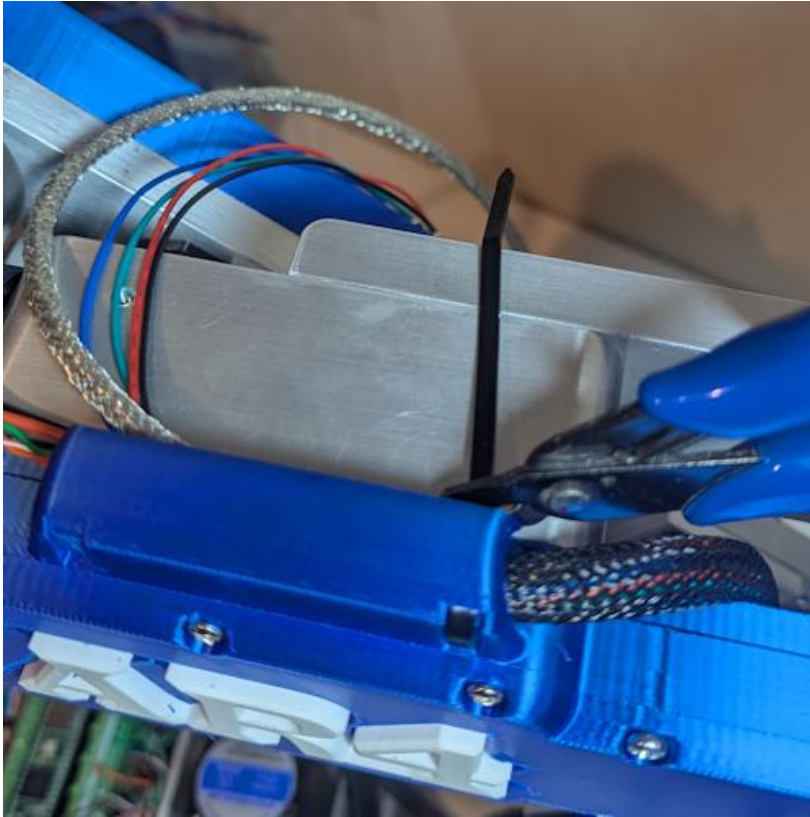

Tighten cable tie securing wires and cable to the J5 side spacer then trim cable tie.

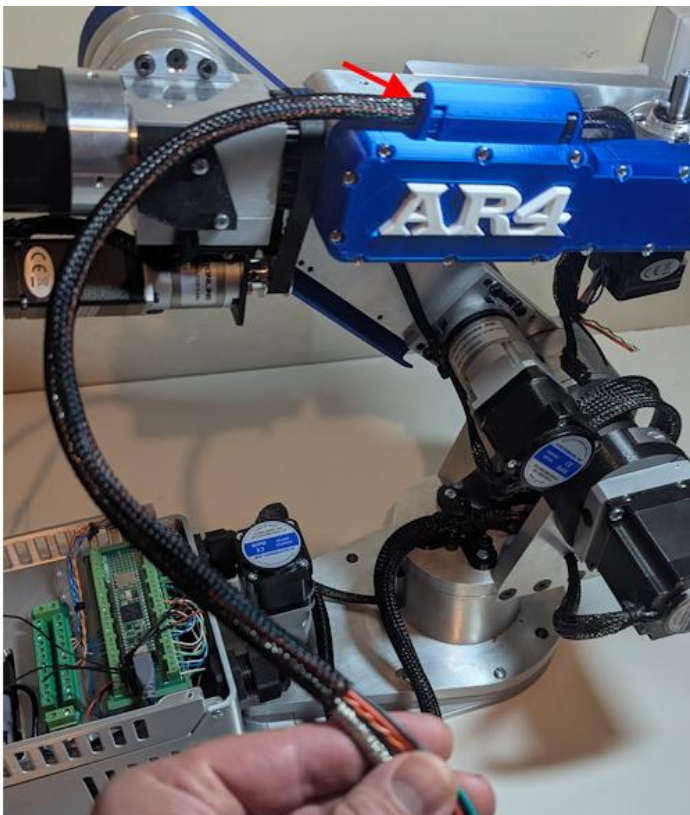

Cut length of ¼" braided sleeve to a length of 40cm long then route J6 motor wires, encoder wires, as well as pneumatic tube or gripper power wires through the.

Braided sleeve should extend under the J5 side spacer (red arrow).

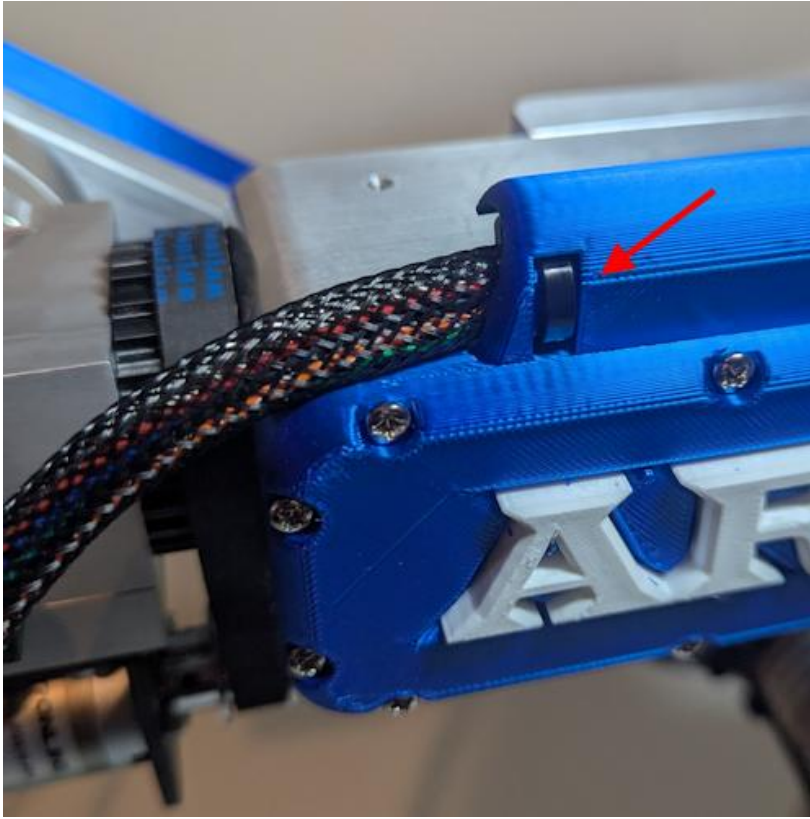

Secure J6 cable/wires to J5 side spacer as shown using small cable tie.

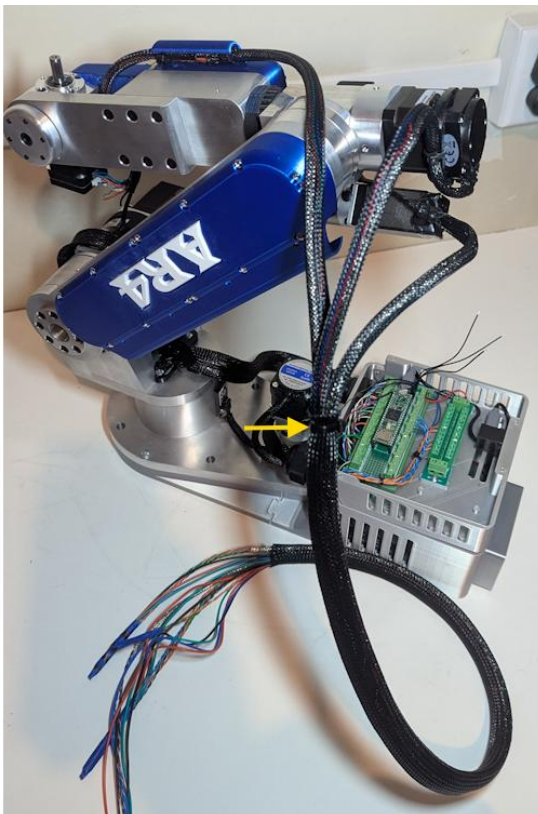

Cut length of 3/4" braided sleeve to a length of 70cm long then route J4, J5 and J6 motor wires and Cat6 cables through the sleeve.

Where the 3/4" braided sleeve just overlaps the braided sleeves for the J4, J5 and J6 wire/cables wrap and tighten a small cable tie (yellow arrow).

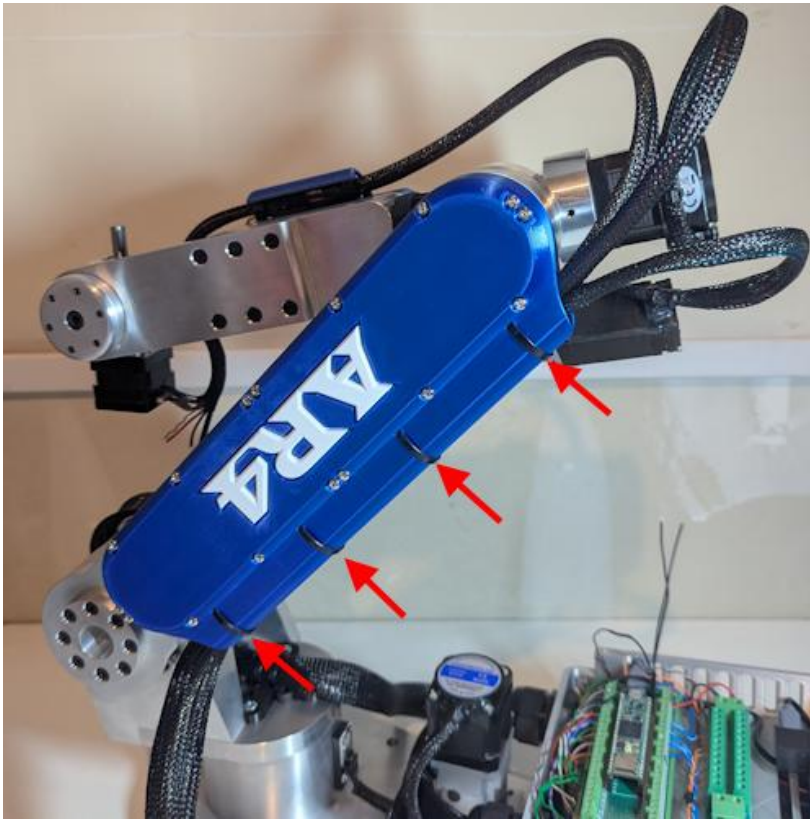

Insert the complete harness back into the J2 wireway as shown.

Secure wire harness to wireway with 4 small cable ties (red arrows).

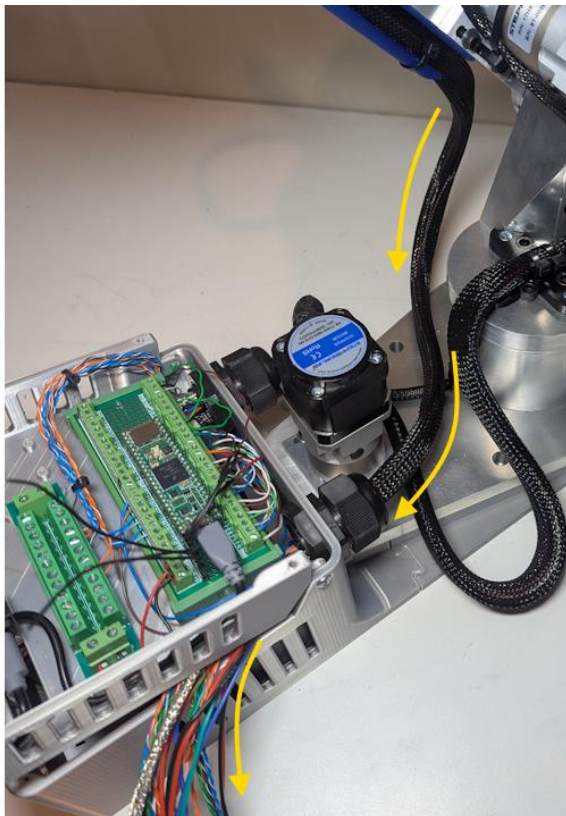

Route the J4, J5 & J6 wires/cables through the right-side gland nut as shown and then tighten nut.

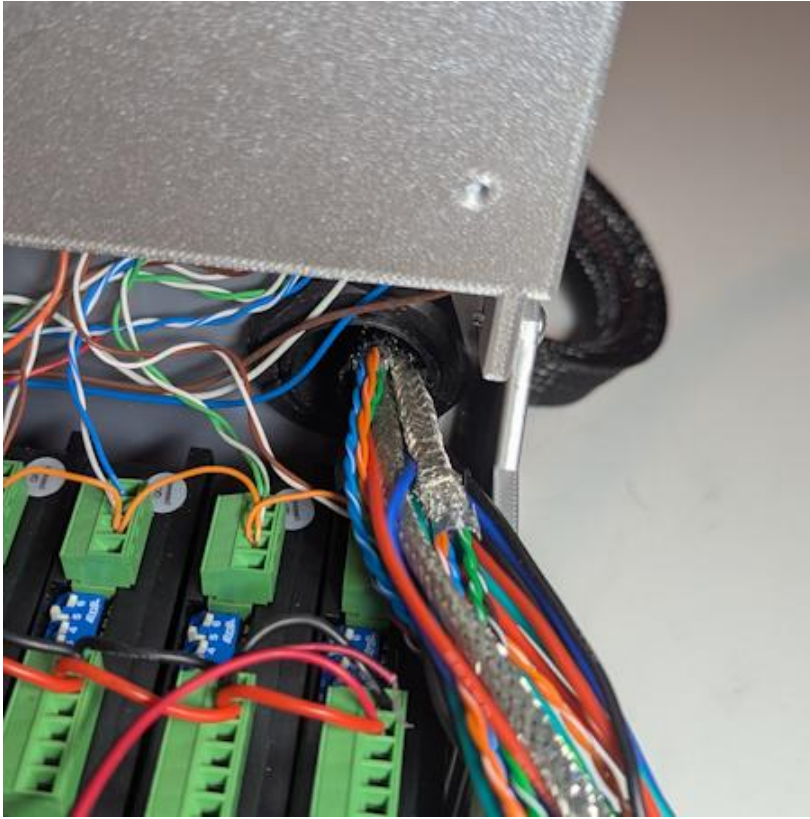

Be careful when routing wires through the gland nut and into enclosure that they so not get caught on or pull on any of the other wires.

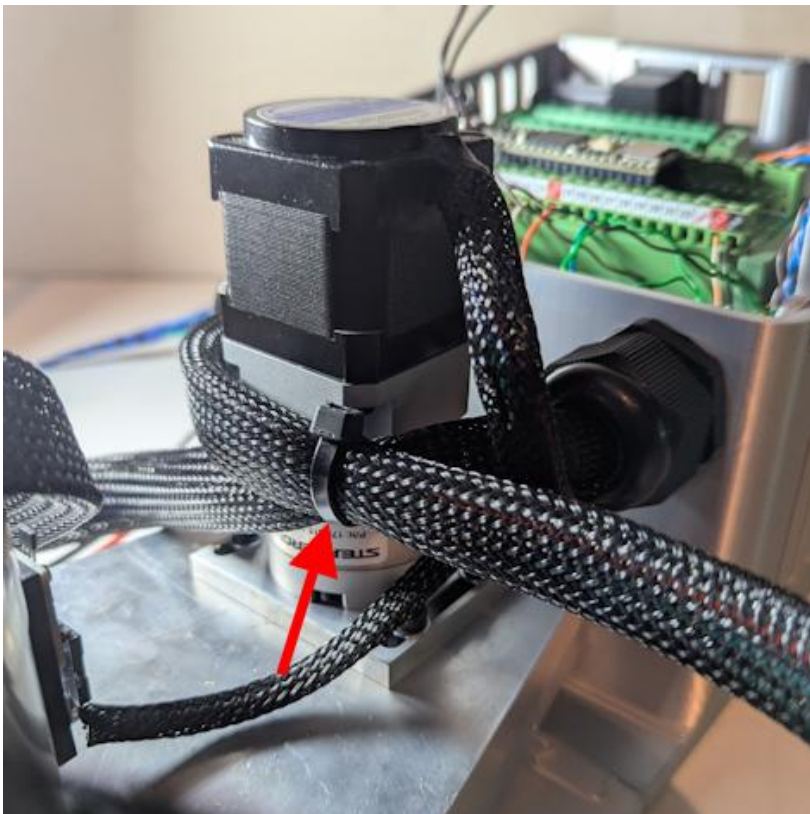

Use a medium size cable tie to secure the J4-6 cable sleeve to the J1-3 cable sleeve as shown.

The J4-6 sleeve should be on top and located as shown so that the sleeve stays near the top of the J1 gearbox but just below the black motor housing.

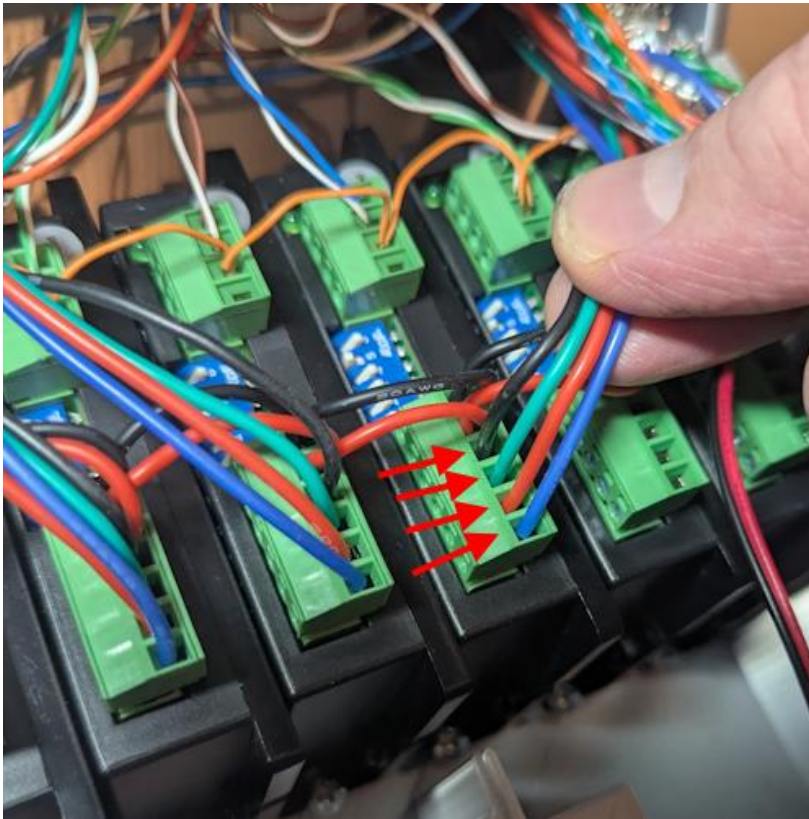

Find the motor/cable wires that were taped with 4 marks for J4 then route and cut the wires as shown so that they are the appropriate length to reach the J4 driver terminals.

Connect the (4) J4 motor wires to the J4 driver terminals as follows:

A+ BLACK

A- GREEN

B+ RED

B- BLUE

NOTE: also see schematics chapter for wiring diagram

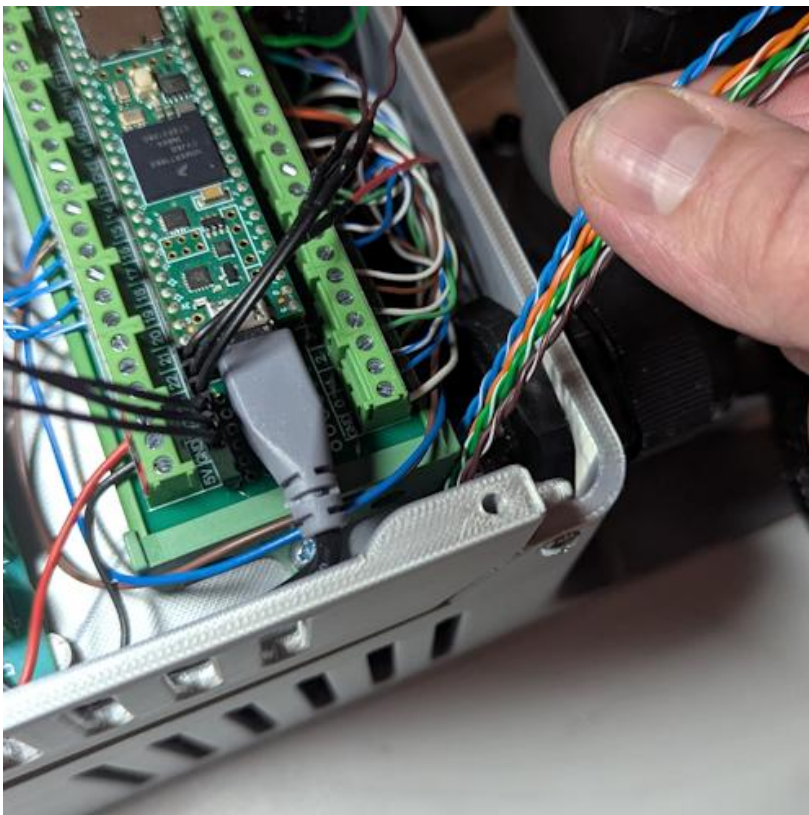

Route the J4 CAT5 twisted pairs up above J1 enclosure tray as shown in photo.

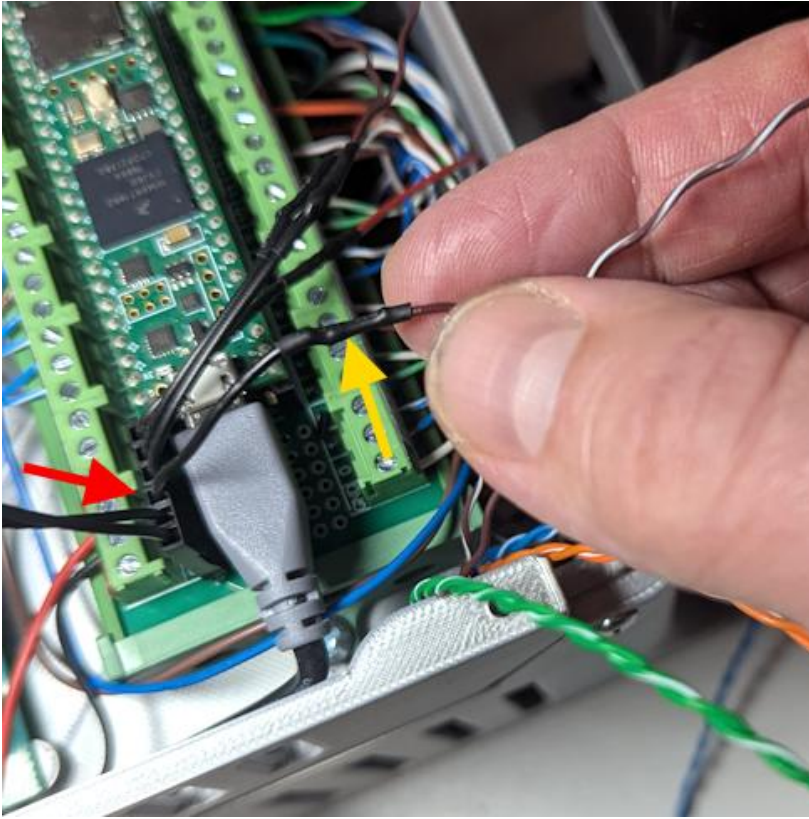

Un-twist the brown wire pair. Trim solid brown wire to length as shown in photo and solder - heat shrink (yellow arrow) the brown wire from the J4 encoder to the first wire on the Dupont 2.54mm 5v lead shown (red arrow).

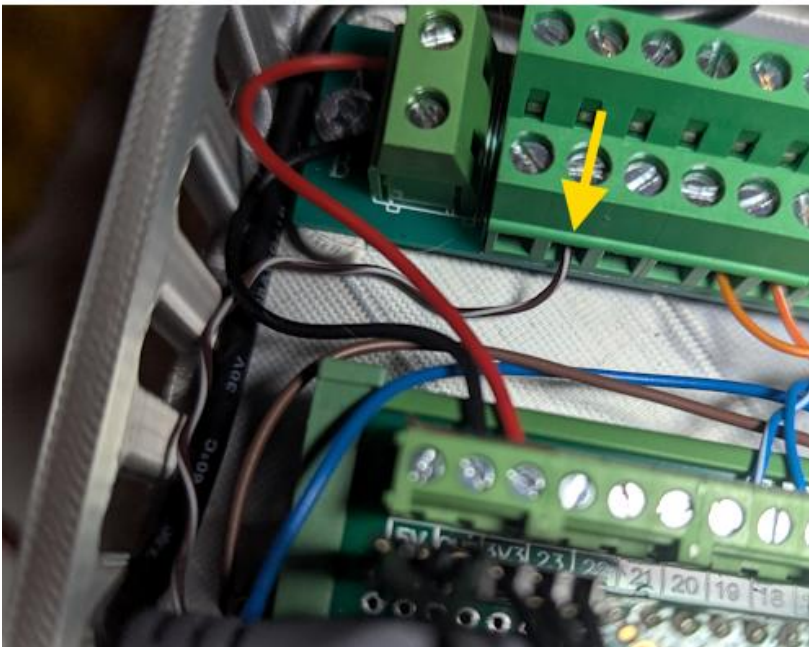

Route the brown/stripe wire over to the 2x12 terminal block and connect the wire to the 2nd terminal as shown.

This is the GND wire from the J4 encoder. **Use Multimeter to verify** the terminal you connected to has continuity to the "B" or GND terminal on the terminal board.

NOTE: the "A" and "B" terminals alternate across the top and bottom terminal rows – the top are not all connected to "A" and the bottom are not all connected to "B".



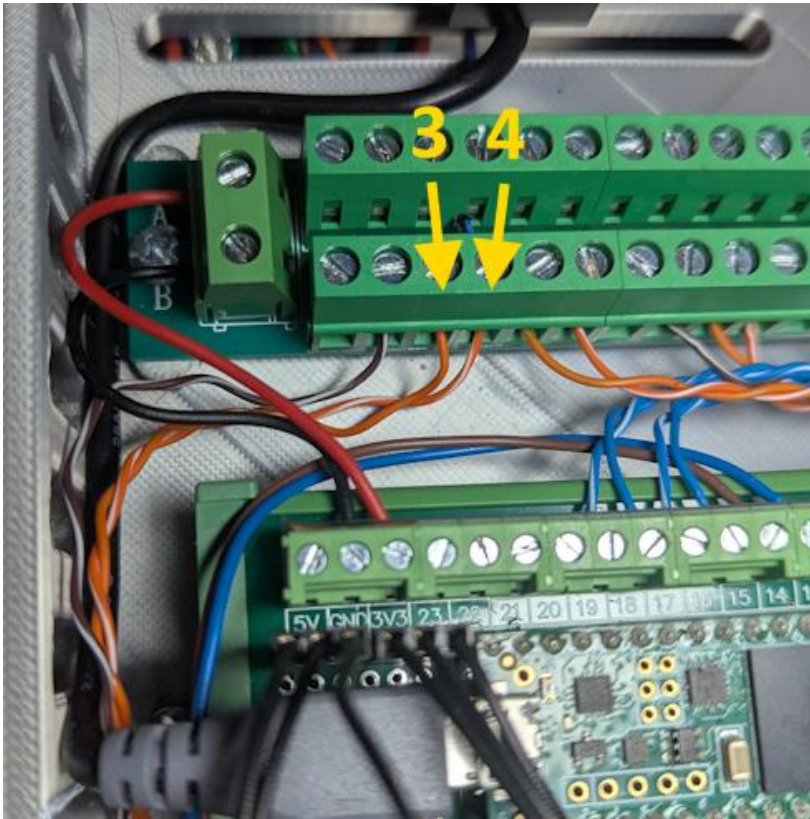

Route the orange pair over to the 2x12 terminal block and connect the solid orange wire to the 3rd terminal & the stripe wire to the 4th terminal.

Use Multimeter to verify the solid orange wire has continuity to the “A” or +3.3v terminal and that the stripe wire has continuity to the “B” or GND terminal at end of terminal board.

NOTE: the “A” and “B” terminals **alternate** across the top and bottom terminal rows – the top are **not** all connected to “A” and the bottom are **not** all connected to “B”.

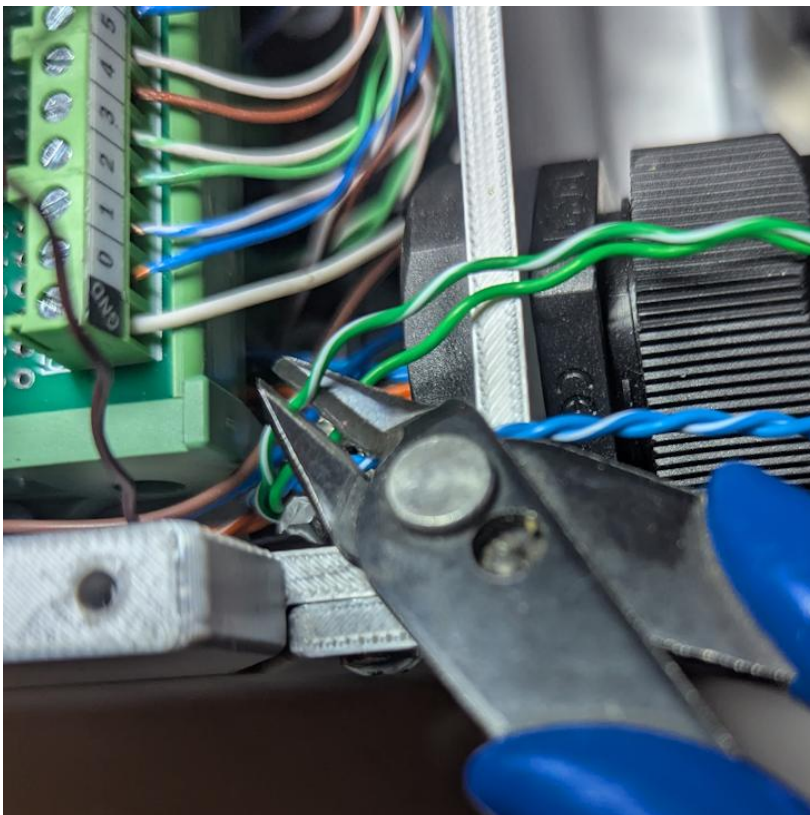

Untwist the green pair of wires from the J4 cable and then trim the green stripe wire as shown.

The green stripe wire will not be used.

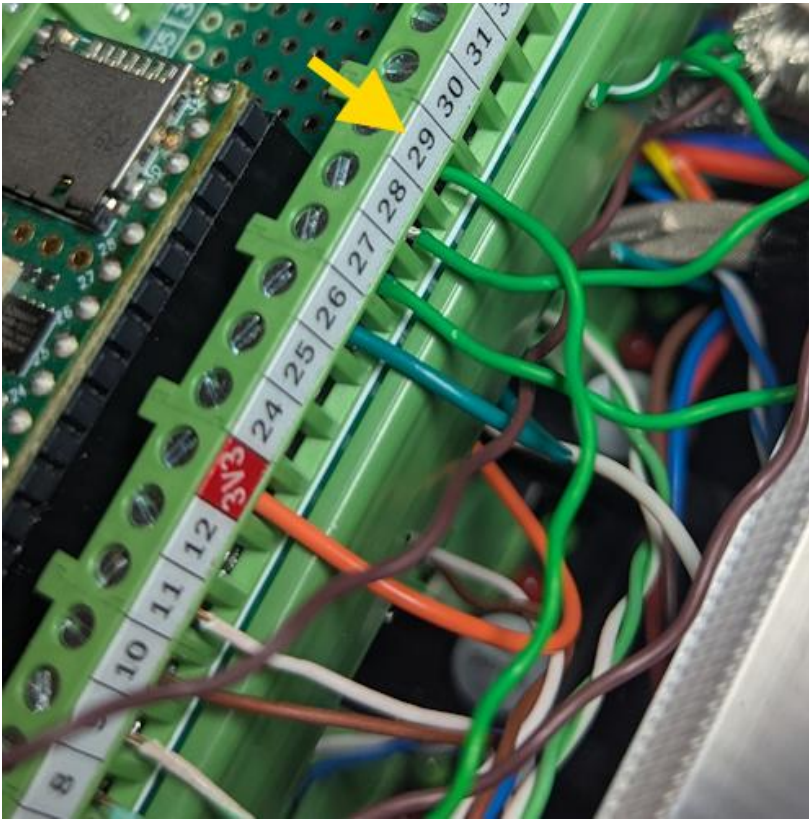

Route and trim the solid green wire to length and connect to terminal 29.

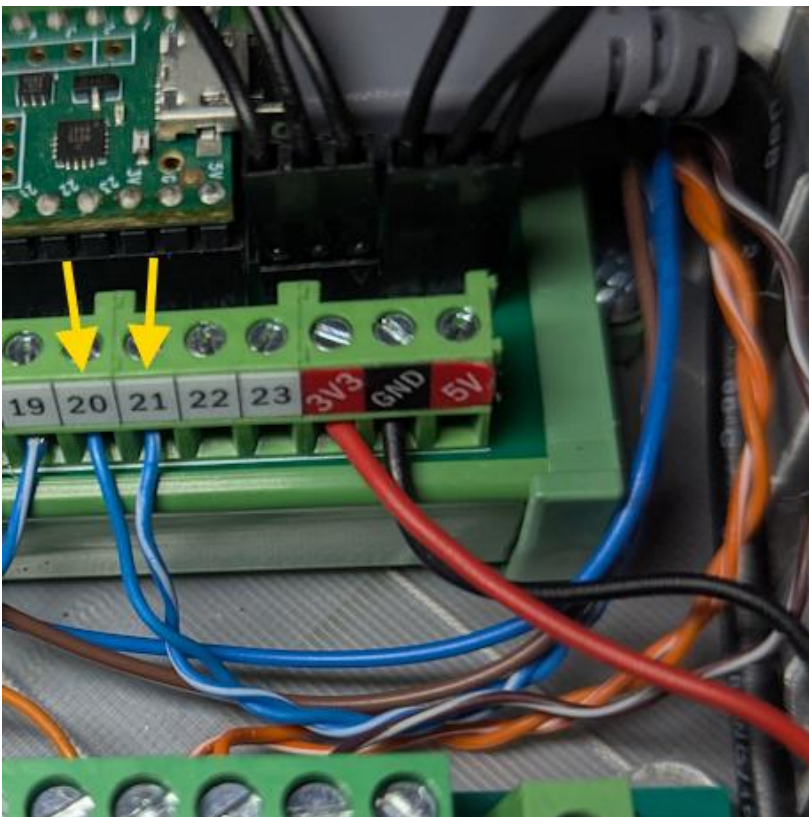

Route and cut the blue wires to length to reach terminal 20 and 21 as shown, strip wire ends.

Connect the solid blue wire to terminal 20.

Connect the stripe blue wire to terminal 21.

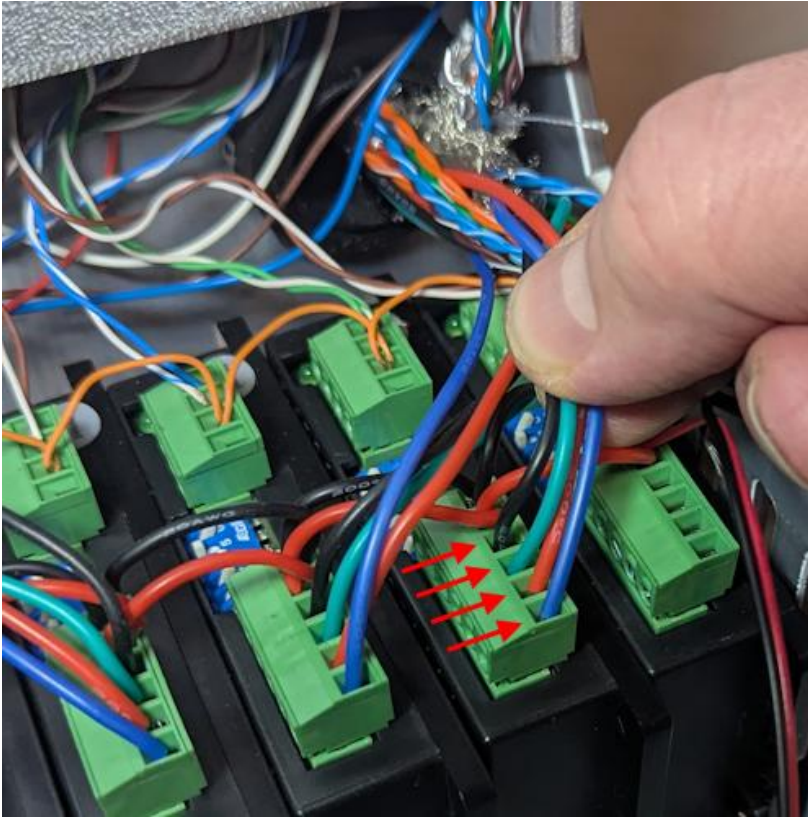

Find the motor/cable wires that were taped with 5 marks for J5 then route and cut the wires as shown so that they are the appropriate length to reach the J5 driver terminals.

Connect the (4) J5 motor wires to the J5 driver terminals as follows:

A+ BLACK

A- GREEN

B+ RED

B- BLUE

NOTE: also see schematics chapter for wiring diagram

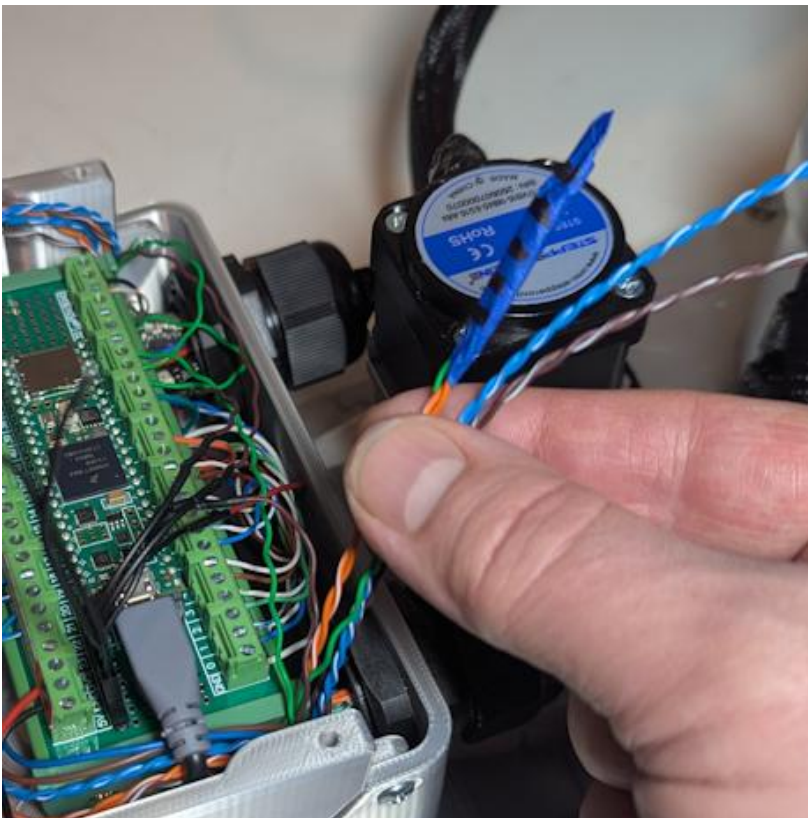

Route the J5 CAT5 twisted pairs up above J1 enclosure tray as shown in photo.

NOTE: Also route the orange pair & green wire that were run separately for the J5 limit switch.



Un-twist the brown wire pair. Trim solid brown wire to length as shown in photo and solder - heat shrink (yellow arrow) the brown wire from the J4 encoder to the second wire on the Dupont 2.54mm 5v lead shown (red arrow).

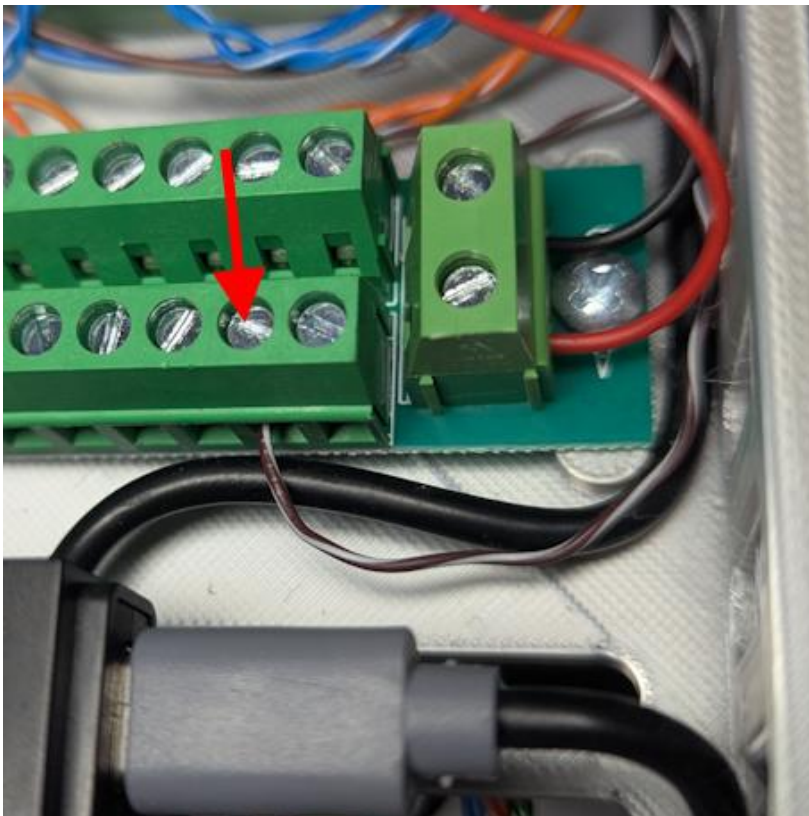

Route the brown/stripe wire over to the 2x12 terminal block and connect the wire to the 2nd terminal on top row of terminal board as shown.

This is the GND wire from the J5 encoder. **Use Multimeter to verify** the terminal you connected to has continuity to the “B” or GND terminal on the terminal board.

NOTE: the “A” and “B” terminals **alternate** across the top and bottom terminal rows – the top are **not** all connected to “A” and the bottom are **not** all connected to “B”.

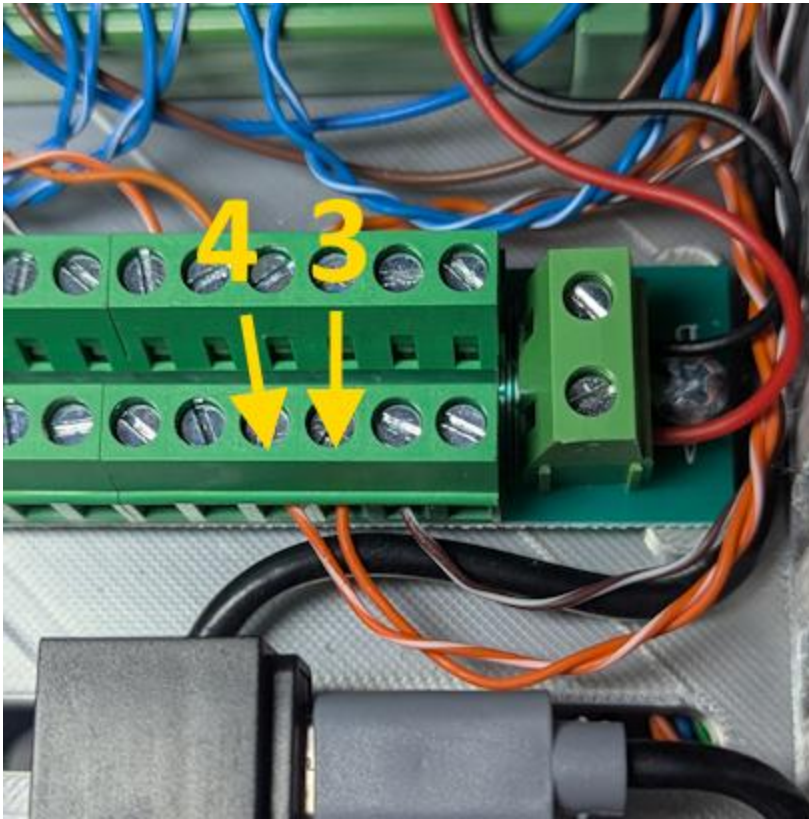

Route the orange pair over to the 2x12 terminal block and connect the solid orange wire to the 3rd terminal & the stripe wire to the 4th terminal.

Use Multimeter to verify the solid orange wire has continuity to the “A” or +3.3v terminal and that the stripe wire has continuity to the “B” or GND terminal at end of terminal board.

NOTE: the “A” and “B” terminals **alternate** across the top and bottom terminal rows – the top are **not** all connected to “A” and the bottom are **not** all connected to “B”.

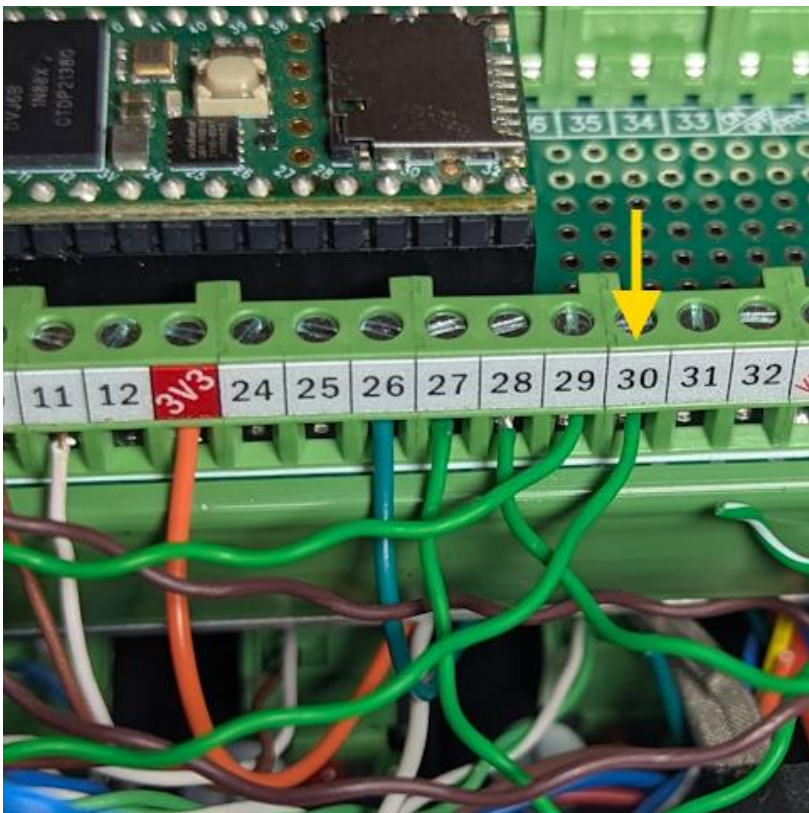

Untwist the green wire pair, trim the white with green stripe wire as it will not be used.

Route and trim the solid green wire to length and connect to terminal 30.

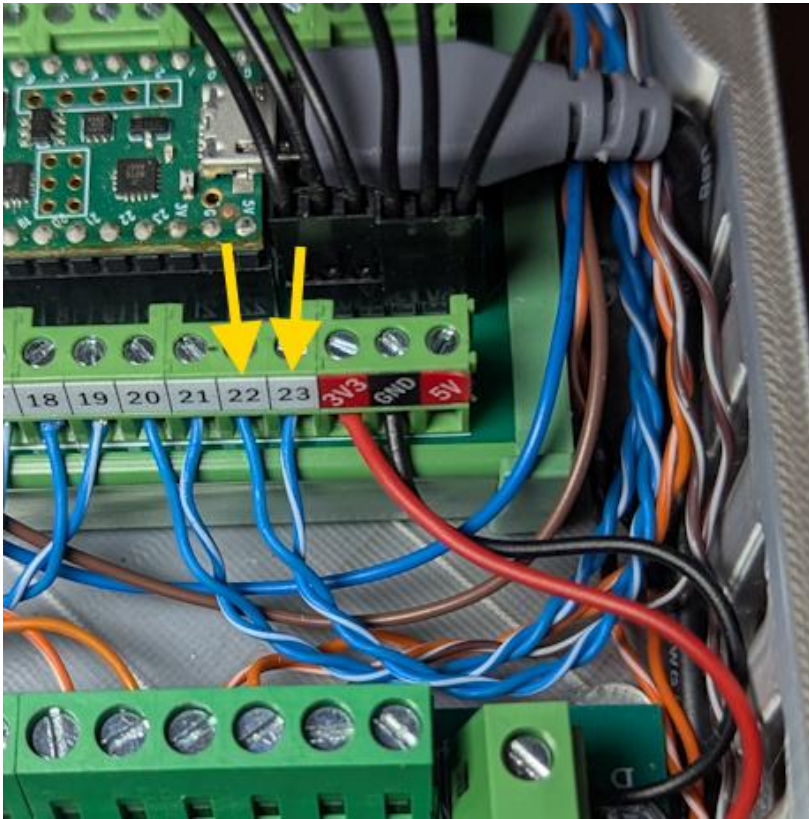

Route and cut the blue wires to length to reach terminal 22 and 23 as shown, strip wire ends.

Connect the solid blue wire to terminal 22.

Connect the stripe blue wire to terminal 23.

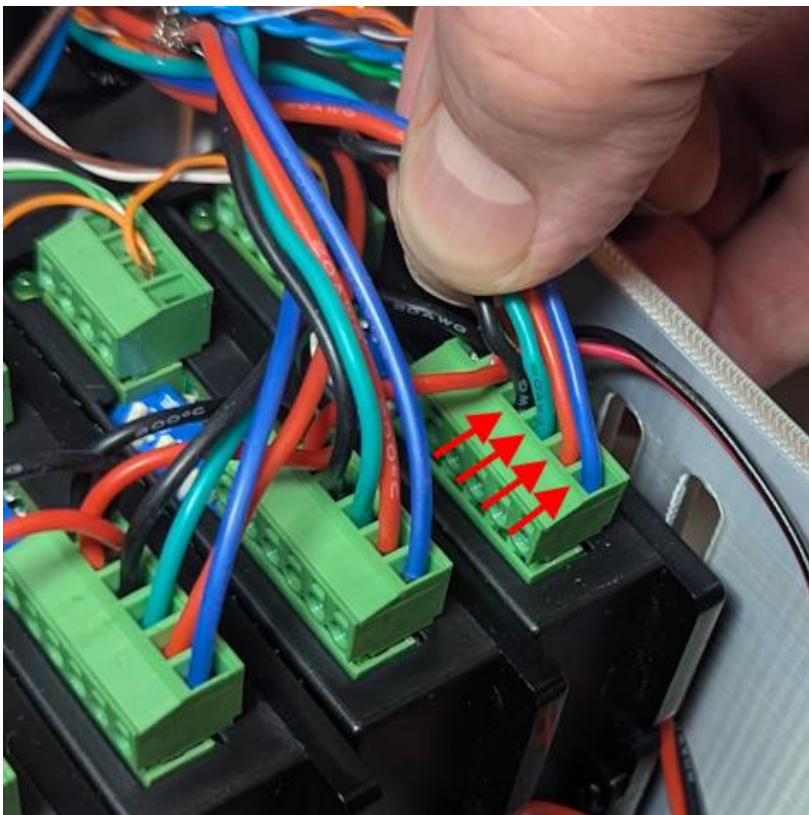

Find the motor/cable wires that were taped with 6 marks for J6 then route and cut the wires as shown so that they are the appropriate length to reach the J6 driver terminals.

Connect the (4) J6 motor wires to the J6 driver terminals as follows:

A+ BLACK

A- GREEN

B+ RED

B- BLUE

NOTE: also see schematics chapter for wiring diagram



Route the J6 CAT5 twisted pairs up above J1 enclosure tray as shown in photo.

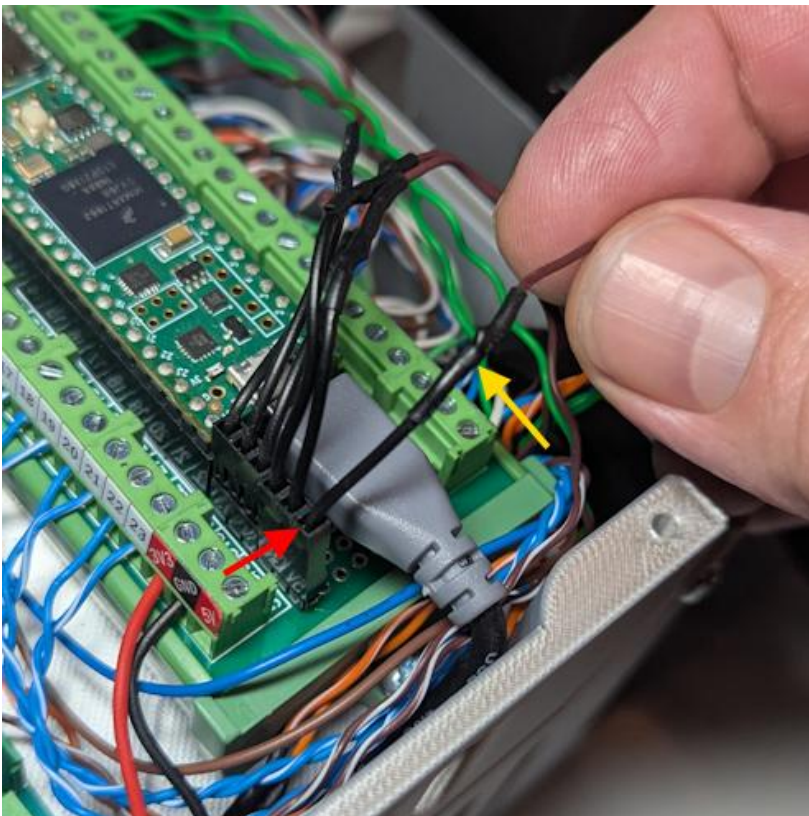

Un-twist the brown wire pair. Trim solid brown wire to length as shown in photo and solder - heat shrink (yellow arrow) the brown wire from the J4 encoder to the third wire on the Dupont 2.54mm 5v lead shown (red arrow).

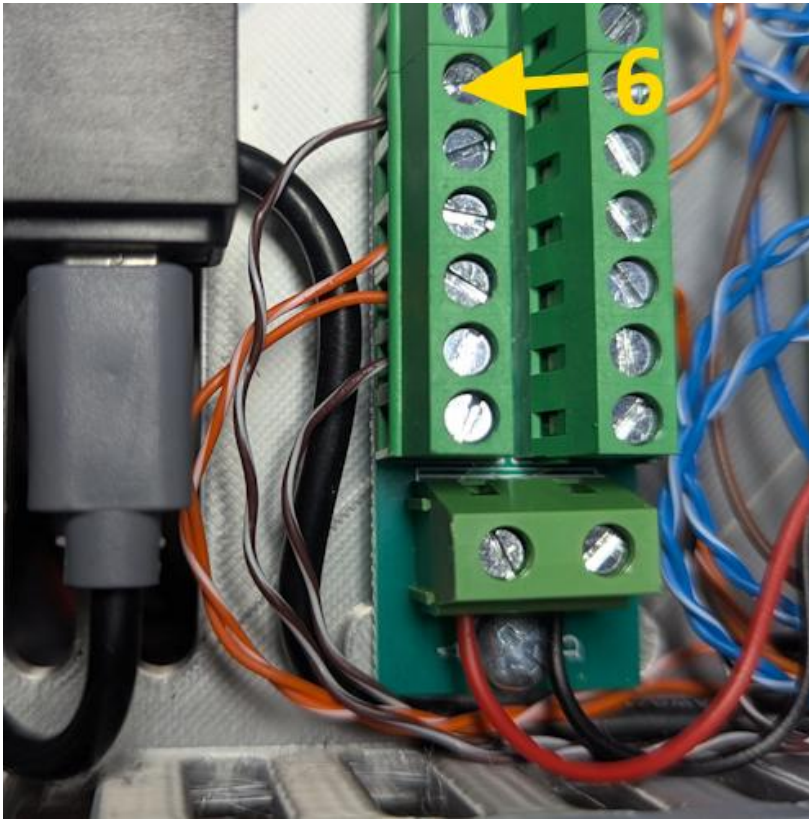

Route the brown/stripe wire over to the 2x12 terminal block and connect the wire to the 6th terminal on top row of terminal board as shown.

This is the GND wire from the J6 encoder. **Use Multimeter to verify** the terminal you connected to has continuity to the “B” or GND terminal on the terminal board.

NOTE: the “A” and “B” terminals alternate across the top and bottom terminal rows – the top are **not** all connected to “A” and the bottom are **not** all connected to “B”.

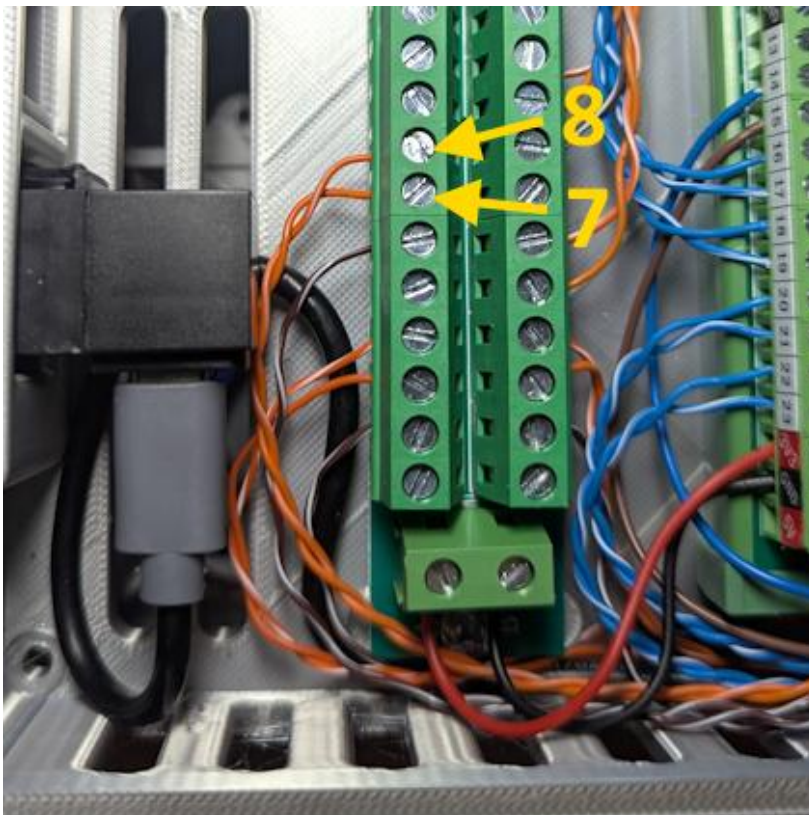

Route the orange pair over to the 2x12 terminal block and connect the solid orange wire to the 7th terminal & the stripe wire to the 8th terminal.

Use Multimeter to verify the solid orange wire has continuity to the “A” or +3.3v terminal and that the stripe wire has continuity to the “B” or GND terminal at end of terminal board.

NOTE: the “A” and “B” terminals alternate across the top and bottom terminal rows – the top are **not** all connected to “A” and the bottom are **not** all connected to “B”.

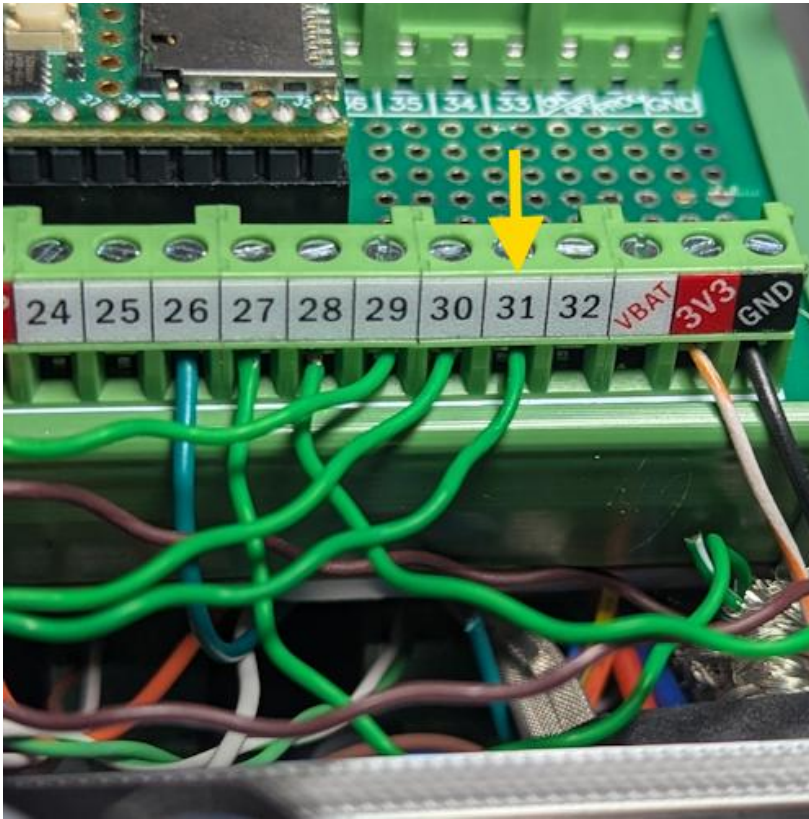

Untwist the green wire pair.

DO NOT CUT OFF THE STRIPE WIRE AS WE HAVE DONE FOR ALL THE OTHER JOINTS

Route the green stripe wire back underneath the tray as it will be used for the servo gripper signal wire.

Route and trim the solid green wire to length and connect to terminal 31. (yellow arrow).

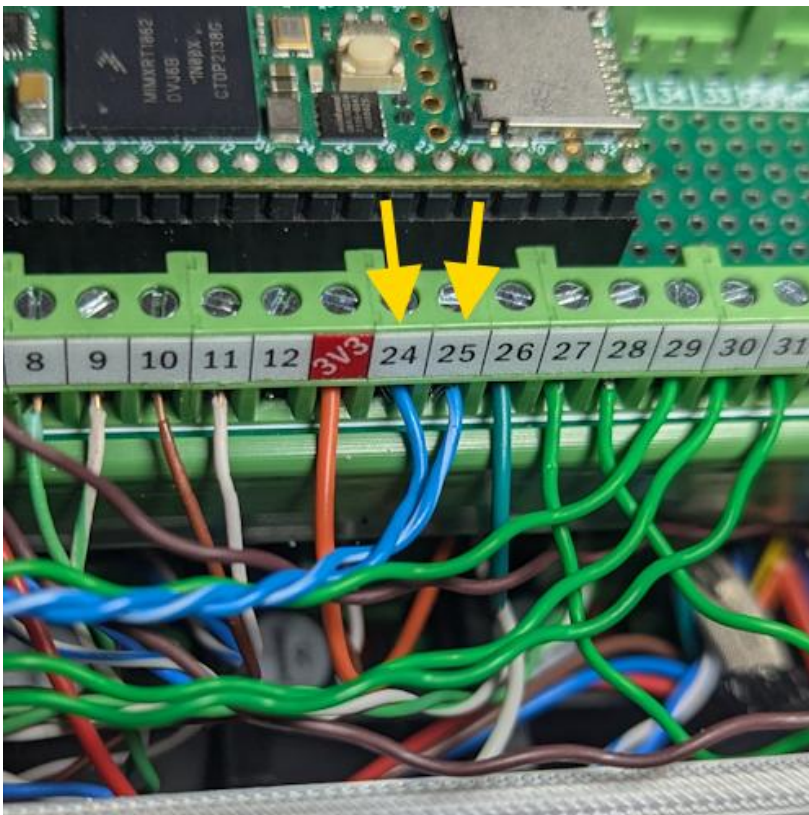

Route and cut the blue wires to length to reach terminal 24 and 25 as shown, strip wire ends.

Connect the solid blue wire to terminal 24.

Connect the stripe blue wire to terminal 25.

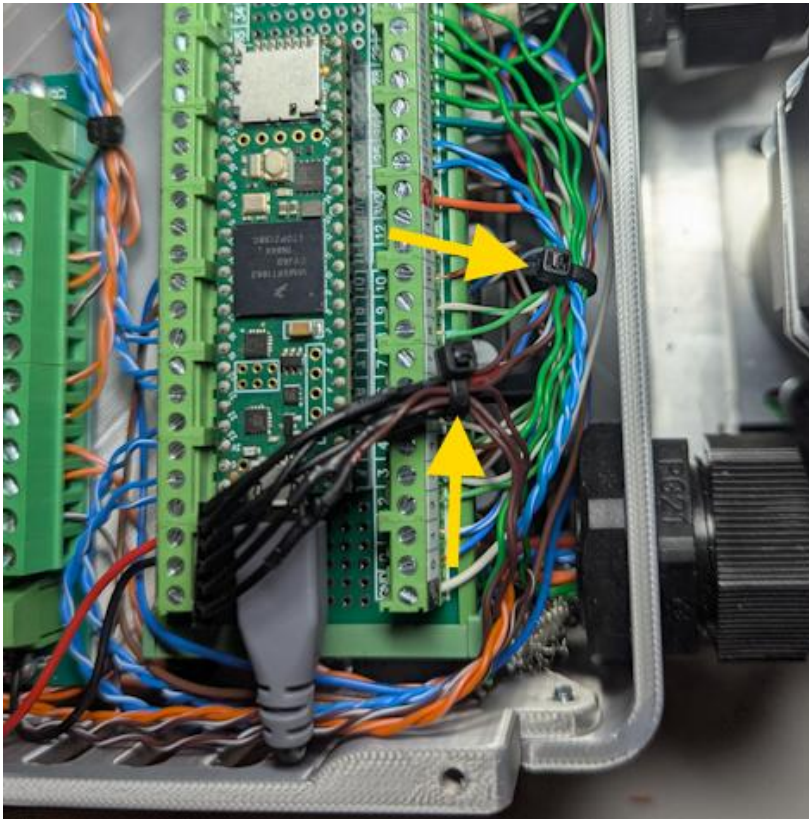

Use (2) small cable ties – use one to bundle the 5v encoder power wires and use the other to bundle the wires shown at the front of the enclosure.

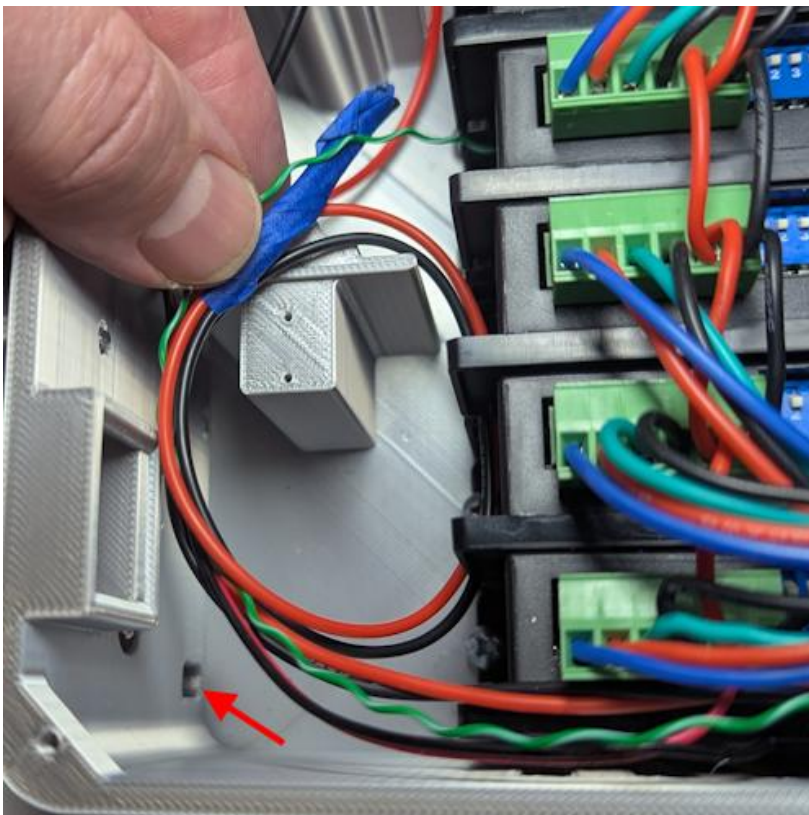

Tuck the red and black servo gripper power wires along with the white/green stripe signal wire down into the bottom of the base enclosure. Chapter 5 will continue the instruction to complete wiring and installation of the servo gripper.

If you have run pneumatic tubing for a servo gripper – route the 4mm tubing out the rear access port indicated by the red arrow in photo. Chapter 4 will continue the instruction to complete the installation of the pneumatic gripper.

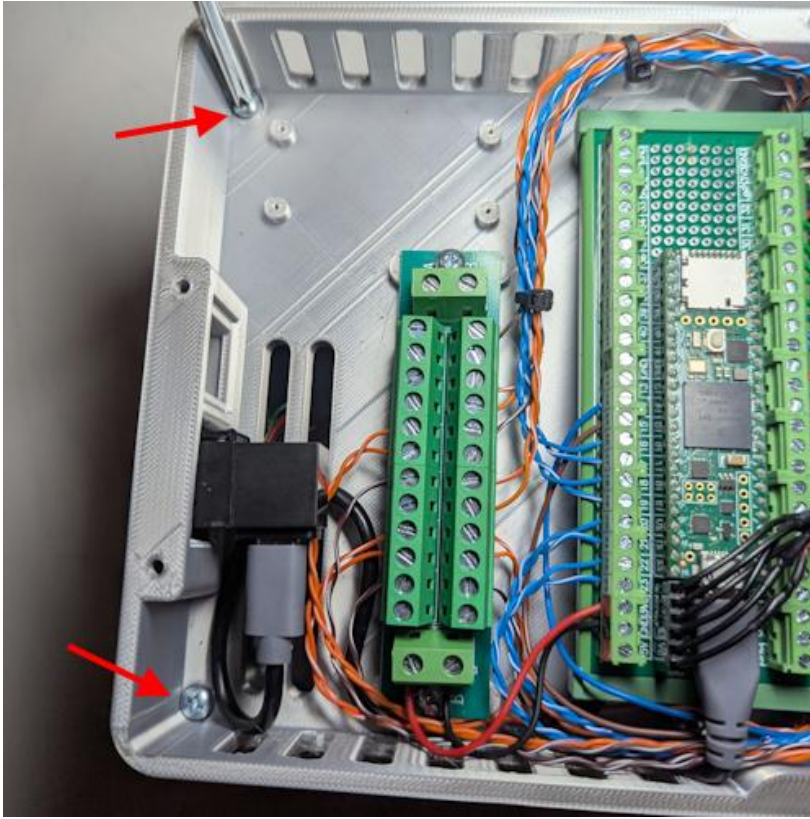

Secure the enclosure tray down to the base enclosure using (2) #6 thread form screws in the tray corners as shown.

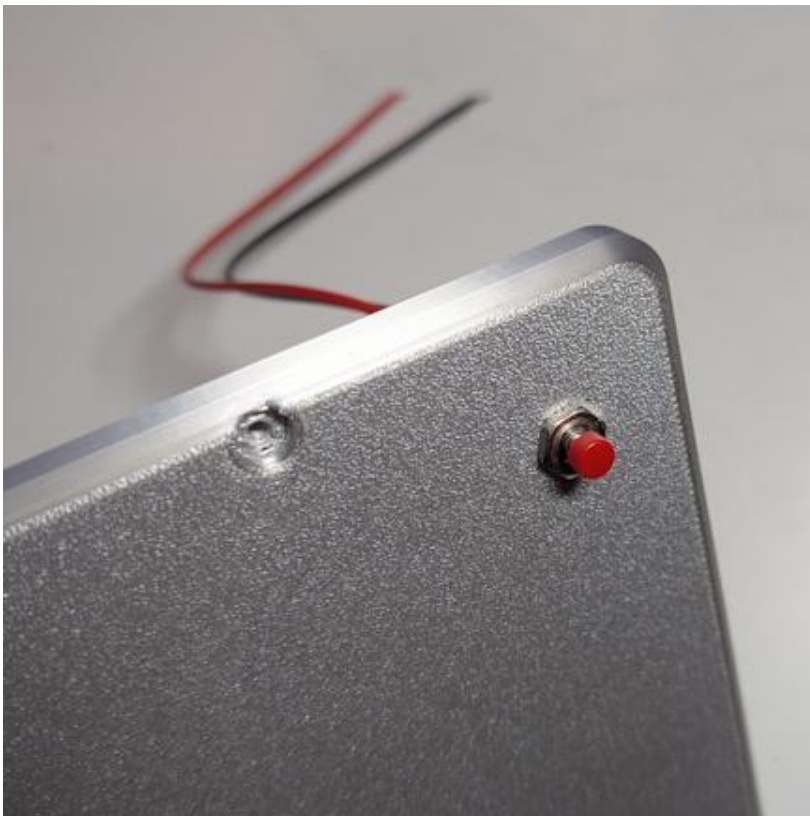

Install PBS-110 push button switch in enclosure lid as shown.

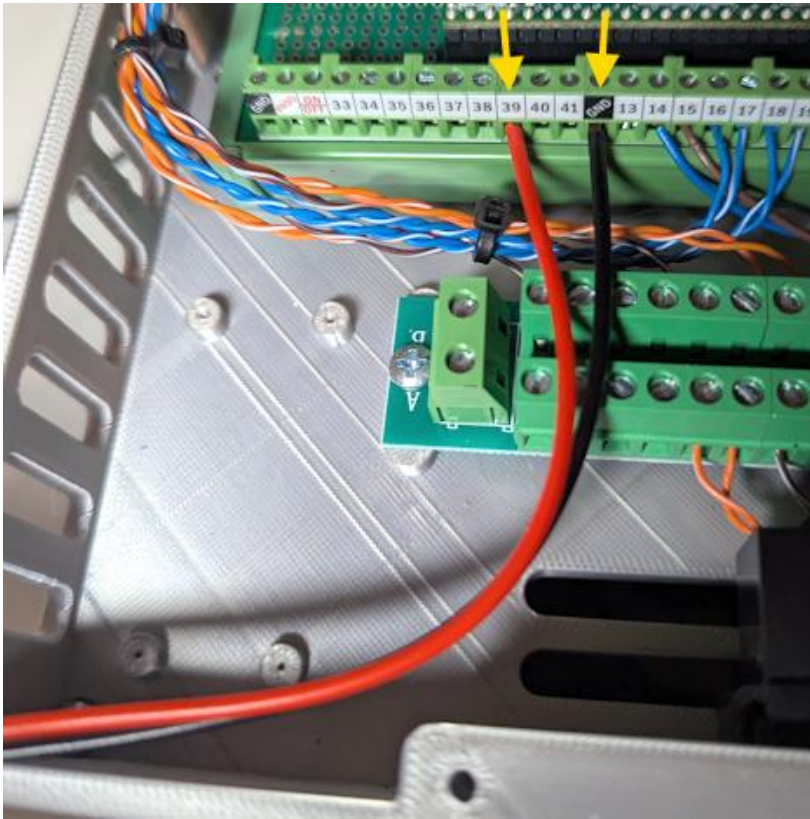

Connect red wire from push button to terminal 39 on Teensy4.1 terminal board.

Connect the black wire from push button to the GND terminal shown on Teensy4.1 terminal board.



Tuck push button switch wires under enclosure lid and secure to the tray using (4) #6 thread form screws

BEFORE WE CAN INSTALL THE J6 GRIPPER MOUNT & LIMIT SWITCH WE WILL NEED TO JOG JOINT 5 TO BE ORIENTED IN THE DOWN POSITION.

PLEASE JUMP TO CHAPTER 8 – STARTUP PROCEDURE AND GO THROUGH THE FIRST 3 PAGES AND VERIFY YOU CAN JOG EACH OF THE ROBOT JOINTS AS OUTLINED IN THE STARTUP PROCEDURE.

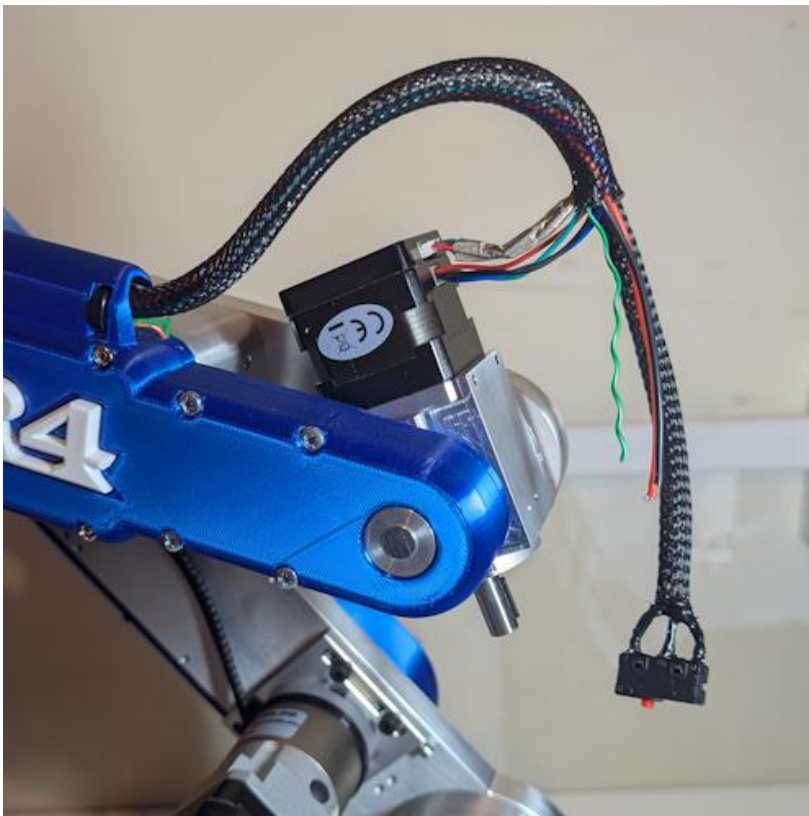

Jog joint 5 to an angle of approximately 45° as shown.

Be very careful to feed the limit switch and wires up through the arm while jogging - and that it doesn't get pinched or caught.

Given that we are jogging this joint prior to calibrating its likely you will see a joint out or range error while trying to jog joint 5. In this case go to the Config Settings tab in the software and click the "Force Cal to Rest" button – this resets or forces the calibration to zero so you can continue jogging.

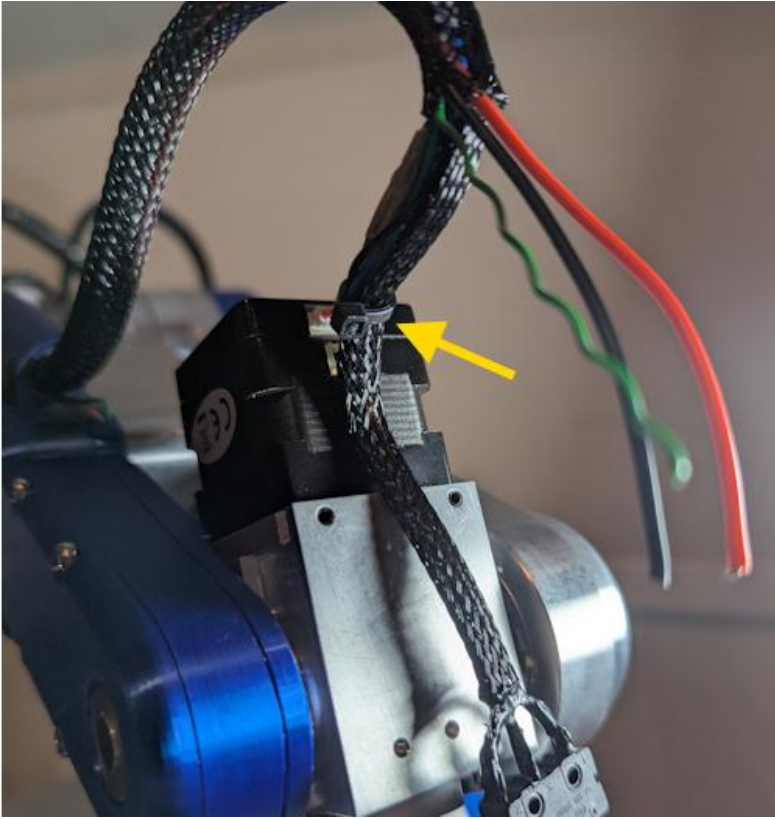

Use a small cable tie to secure the limit switch wires to the base of the J6 motor and encoder wires as shown (yellow arrow).

Don't over tighten the cable tie – it doesn't need to be too tight, just enough to hold the limit switch wires in place.

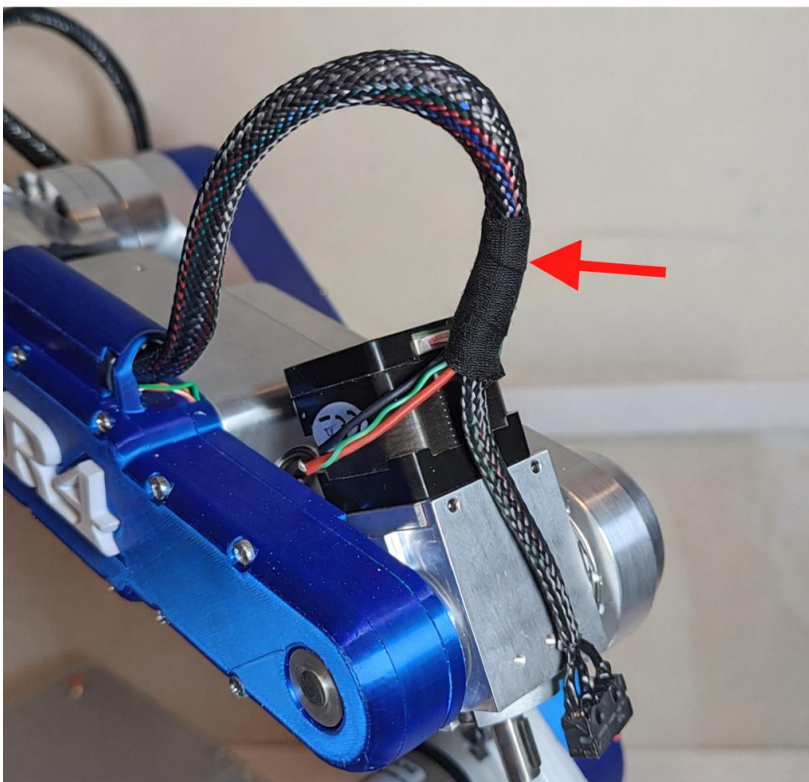

Wrap J6 wires with flexible cloth tape as shown. I prefer to use cloth "Wire Harness Tape".



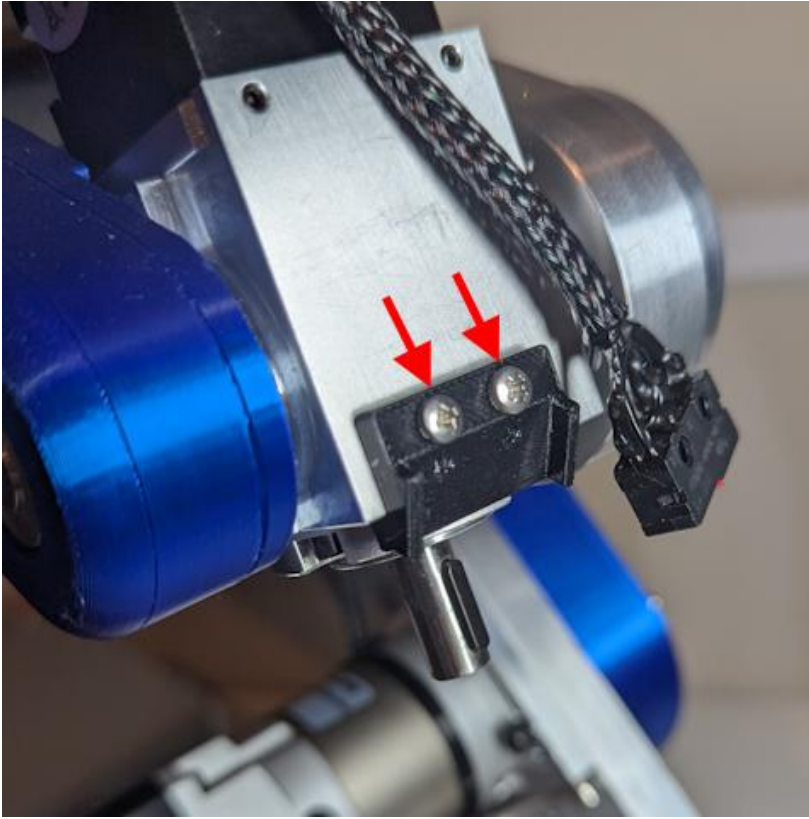

Install the J6 Limit Switch Mount onto the J6 housing and secure with (2) M2.5x6 pan head screws as shown.

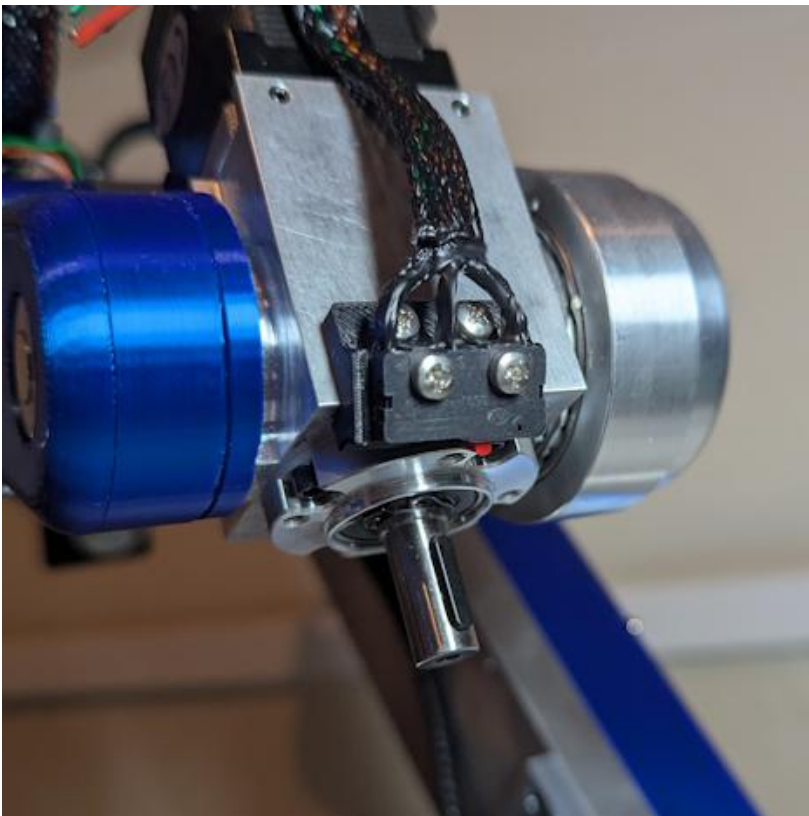

Install J6 limit switch onto J6 mount as shown using (2) M2.5x8 pan head screws.



Install the J6 Limit Contact onto the J6 gripper mount using (2) M2.5x8 Pan Head screws as shown.

(This will be the contact for the J6 limit switch)



You can install the J6 gripper mount at this point if desired, but if you are installing a servo or pneumatic gripper you will need to remove the J6 gripper mount to attach the gripper so it may be better to wait until you have your gripper ready.

Align the slot and key on the J6 motor shaft and install the J6 gripper mount onto the J6 shaft as shown, secure with (1) M4x10 set screw.

The J6 Limit Contact should be facing toward the back.



Secure robot to work surface using M8 or equivalent fasteners with washers. Depending on your work surface these may be threaded hex or cap head screws or lag screws.

I installed M8 threaded inserts into my work table surface and used M8x50 bolts.

**THIS CONCLUDES THE ROBOT ASSEMBLY.
PLEASE REVIEW THE CHAPTER ON ROBOT
STARTUP AS WELL AS THE TUTORIAL VIDEOS
ON THE ANNIN ROBOTICS WEBSITE
TUTORIALS PAGE.**



CHAPTER 3

PLC MODBUS OPTION

The robot can communicate with PLC devices over Modbus RS-485. This is the Modbus communication protocol using the RS-485 electrical standard which allows the robot to communicate with multiple devices.



Modbus Option Bill of Materials

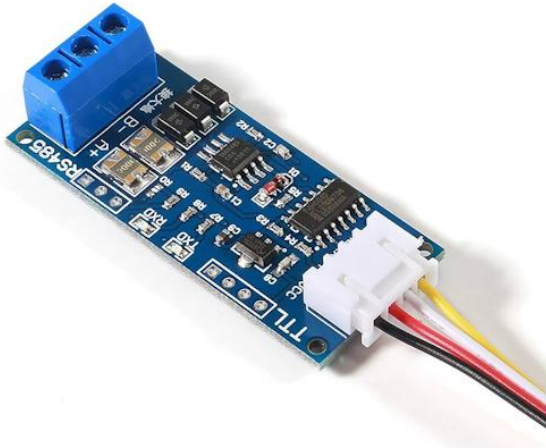

RS-485 TTL Adapter Module



RS-485 Keystone Jack



M 1.6 x 4 mm screws

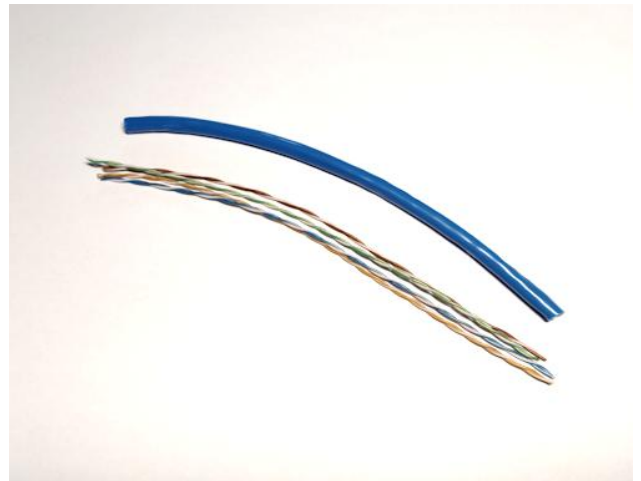

CAT5 wires – 10cm Long

NOTE: Only the orange and green wires will be used.



Modbus Option Assembly

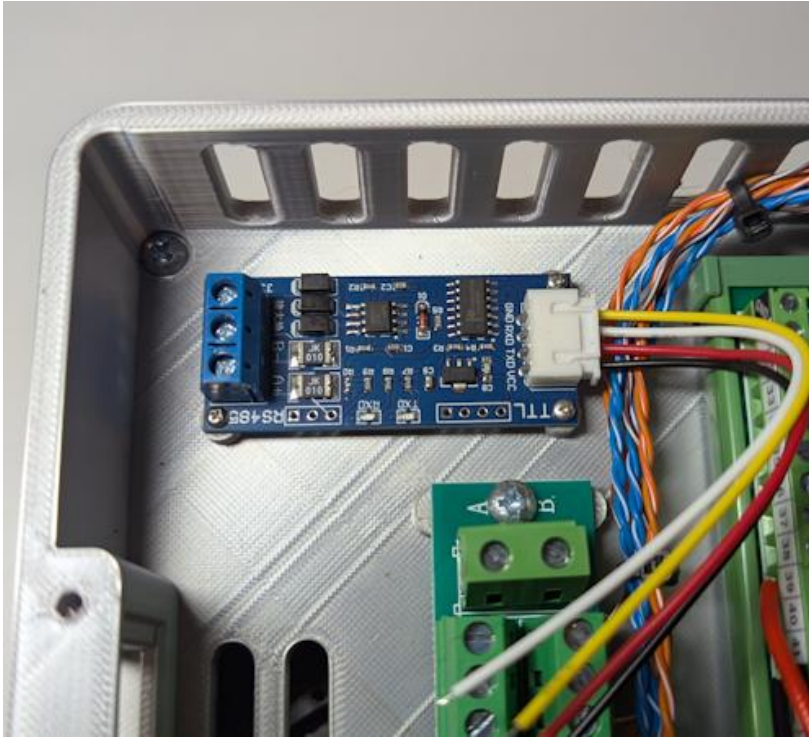

Install the RS-485 TTL board into the bottom of the J1 Base Enclosure Tray as shown and secure with (4) M1.6x4 screws.

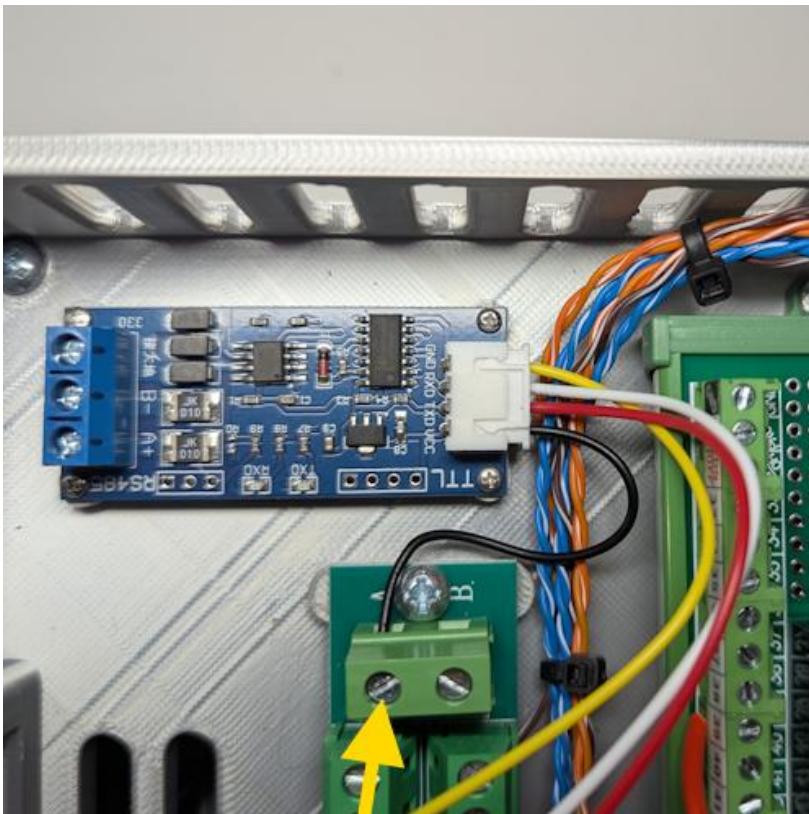

Trim to length and connect the black wire from the TTL RS-485 module to the "A" terminal on the end of the 2x12 terminal board.

The black wire is +3.3v



Trim to length and connect the yellow wire from the TTL RS-485 module to the "B" terminal on the end of the 2x12 terminal board.

The yellow wire is GND

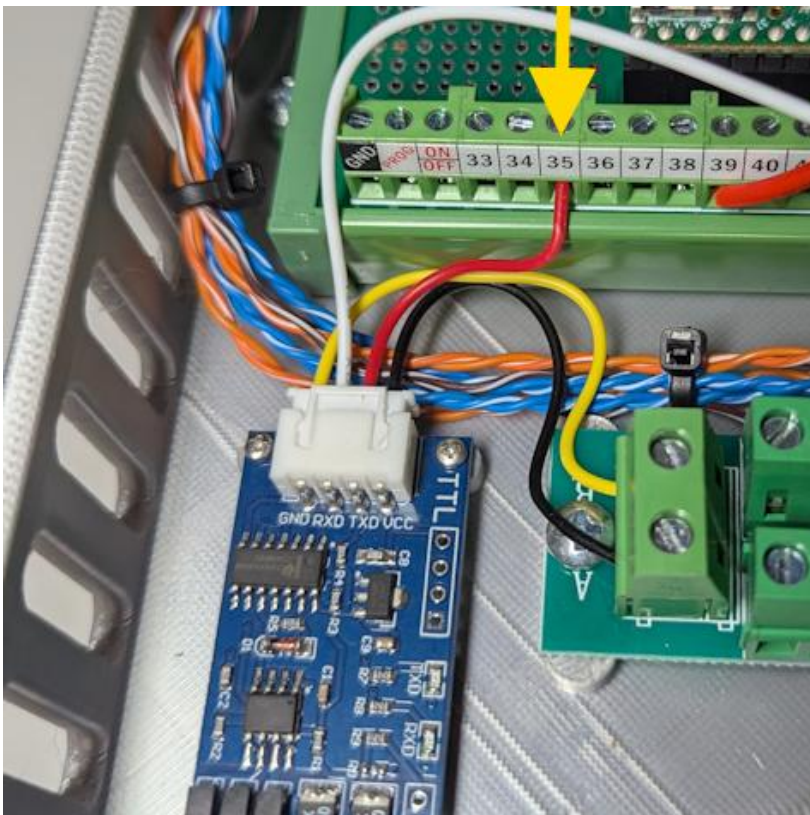

Trim to length and connect the red wire from TTL RS-485 module to terminal 35 on the Teensy4.1 breakout board.



Trim to length and connect the white wire from TTL RS-485 module to terminal 34 on the Teensy4.1 breakout board.

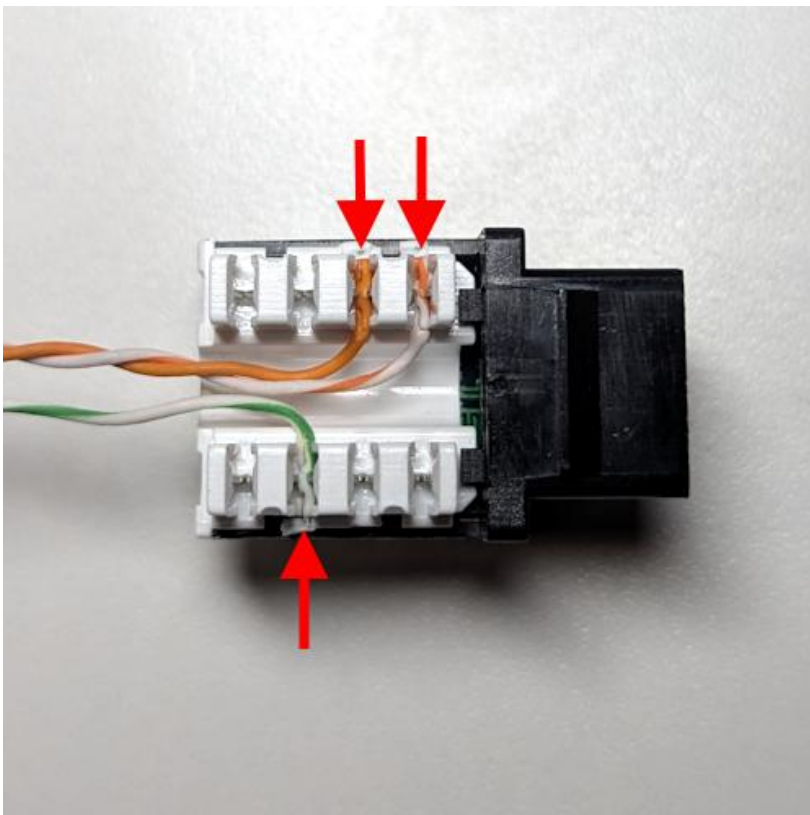

Use a keystone punchdown tool to insert orange twisted pair and stripe green wire into the RJ45 keystone jack as follows:

- Orange/Stripe wire to terminal 1B
- Orange wire to terminal 2B
- Green/Stripe wire to terminal 3B

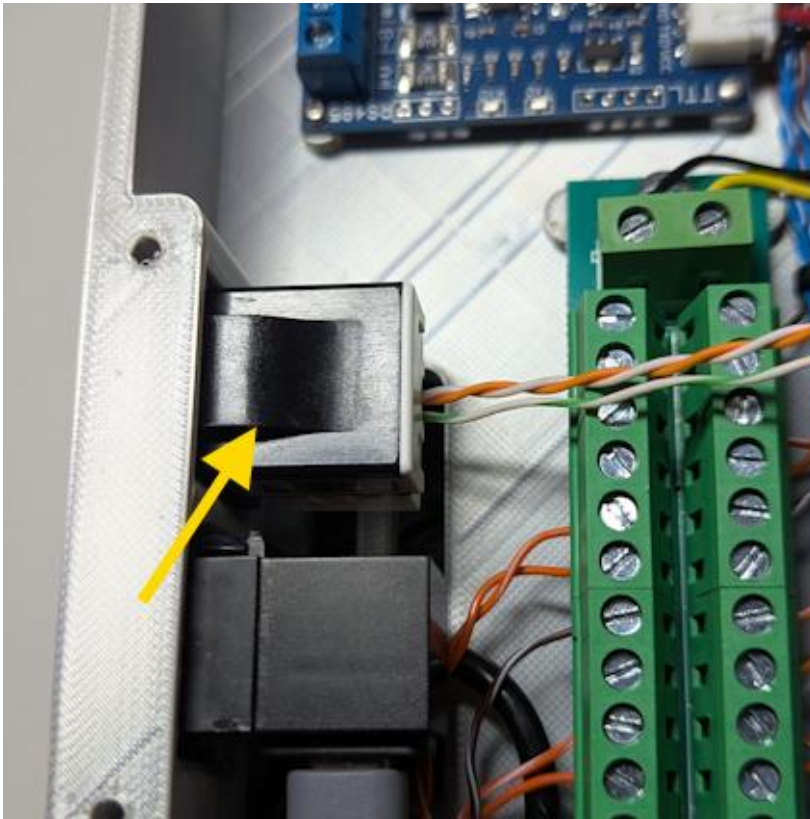

Install RJ-45 keystone jack into base enclosure tray as shown.

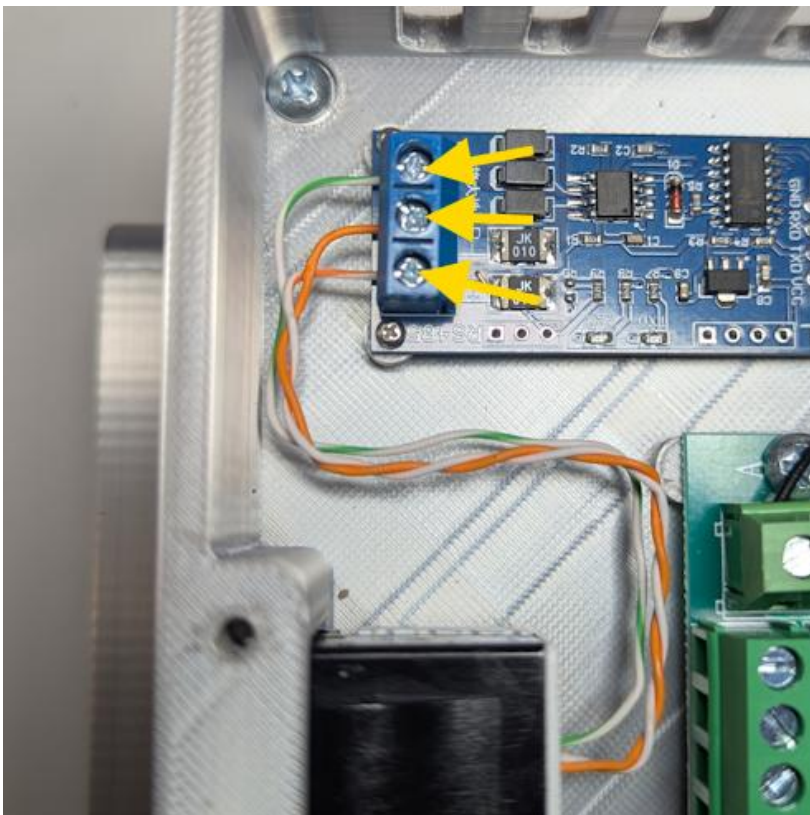

Trim to length and connect the CAT5 wires to the terminals on TTL RS-485 module as follows:

- Orange/Stripe wire to the “A+” terminal
- Orange wire to the “B-” terminal.
- Green/stripe wire to the GND terminal

Replace enclosure lid when complete.

You can now connect your Modbus device to the RJ-45 jack.

DIRECT LOGIC EXAMPLE

Different PLC manufacturers will have different ports, gateways or pinouts for using the Modbus protocol over the RS-485 standard. Many will be a simple 3 wire (A+,B-) with ground.

The Direct Logic PLC's are affordable options although the cable pinout for port 2 is a little less straight forward so I thought I would provide a wiring example here.

AR ROBOT TO DIRECT LOGIC PLC - MODBUS (RS485) CABLE PINOUT



CHAPTER 4

PNEUMATIC GRIPPER

The robot can have multiple different end effectors depending on your needs. This chapter covers the installation of a pneumatic gripper.

Please also see the tutorial video on grippers and IO connections:
<https://youtu.be/76F6dS4ar8Y>



Pneumatic Gripper Bill of Materials



MHF2-8D1 pneumatic gripper.



Silicone Tubing, 2mm ID x 4mm OD High Temp Food Grade Tube Pure Silicone Hose



M3 Male Thread to 3mm 3/25" Barb



1/4" NPT Solenoid Valve 24V Single Coil Pilot-Operated Electric 2 Position 5 Way





VALVE FITTING OPTION 1

Push to Connect Fittings 4mm Tube OD x 1/4 inch NPT Thread



VALVE FITTING OPTION 2

Push to Connect Fittings 1/8" Tube OD x 1/4 inch NPT Thread



5/16" or 8mm nylon pneumatic tubing

-

This tubing is needed to connect solenoid valve to your compressor. Available from Amazon or multiple online suppliers



COMPRESSOR OPTION 1

2 gallon portable air compressor

-

There are numerous options – any small air compressor with regulator can be used.





COMPRESSOR OPTION 2

An airbrush compressor in another compressor option. This option is a little lower cost and quieter although often has less available grip pressure.

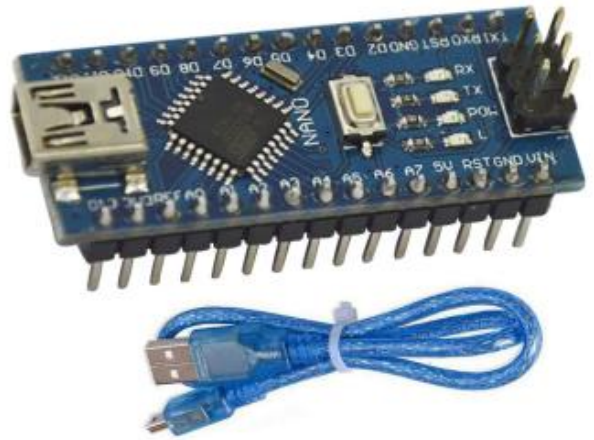

Arduino Nano control board (Arduino Mega can also be used)

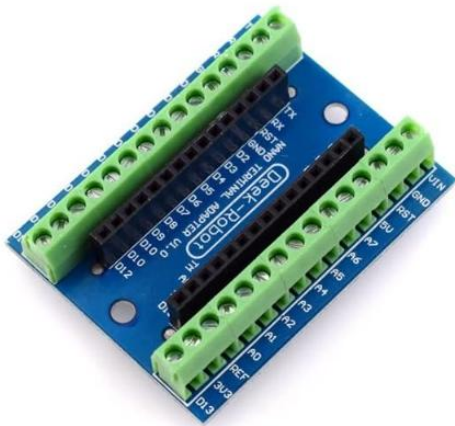

Terminal Adapter Expansion Board for Arduino Nano



5v Relay module





USB-C Keystone Jack.



5.5mm DC power jack socket.



KCD1 SPST rocker switch with lead wires.



24V 8A Power Supply Adapter

-

This power supply is available from Stepperonline (provided with the AR4 robot motors and drivers kit)





Micro USB to USB C Cable



1N4004 Rectifier Diode



20awg 2 conductor black and red wire..
63cm





Auxiliary enclosure

-

The 3D print file for this part can be found along with the robot print files on the downloads page



J1 Base enclosure fan cover

-

This is the same 3D printed part that is used on the robot base.



Gripper Jaws

-

The 3D print file for this part can be found along with the robot print files on the downloads page



Auxiliary enclosure lid

-

The 3D print file for this part can be found along with the robot print files on the downloads page.



Pneumatic Gripper Assembly

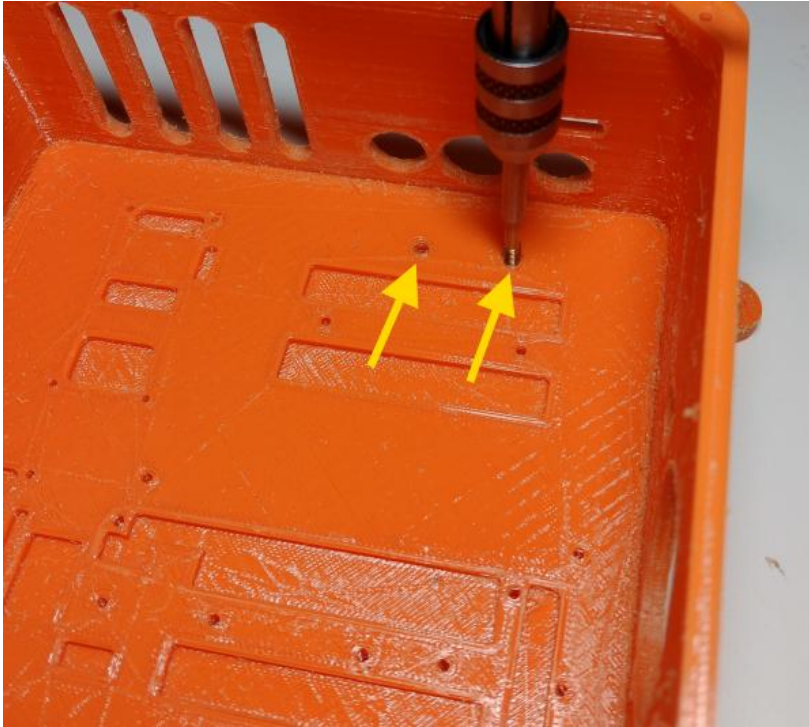

Tap the (2) auxiliary enclosure holes indicated in photo with M4 tap.

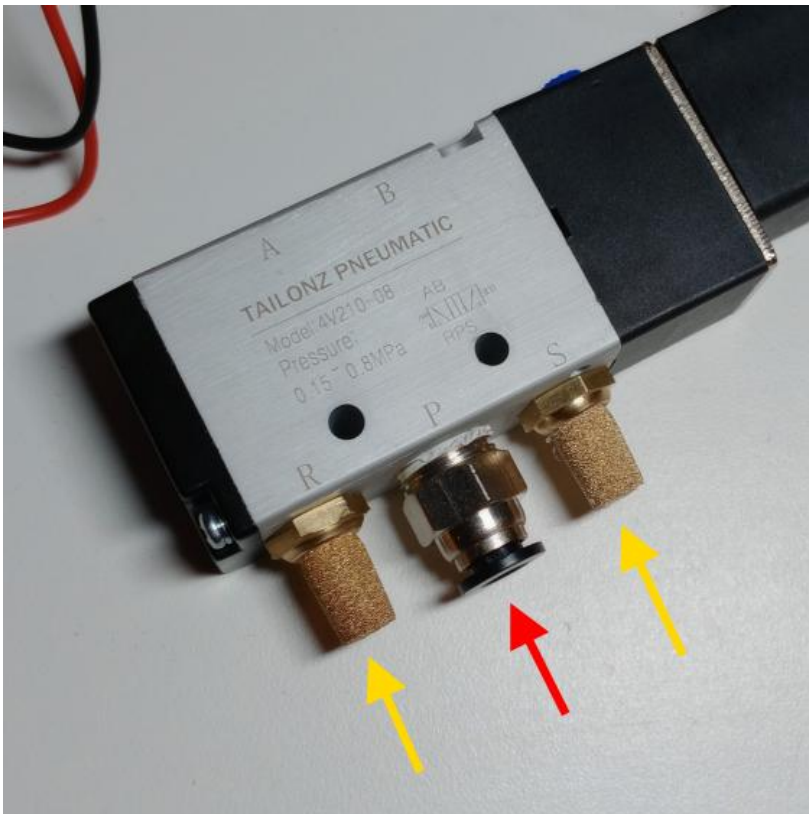

Install $\frac{1}{4}$ " or 6mm push connect pneumatic fitting in center "P" port of solenoid valve as shown (red arrow)

Install (2) pneumatic silencers in the "R"- "S" ports on either side as shown (yellow arrows)

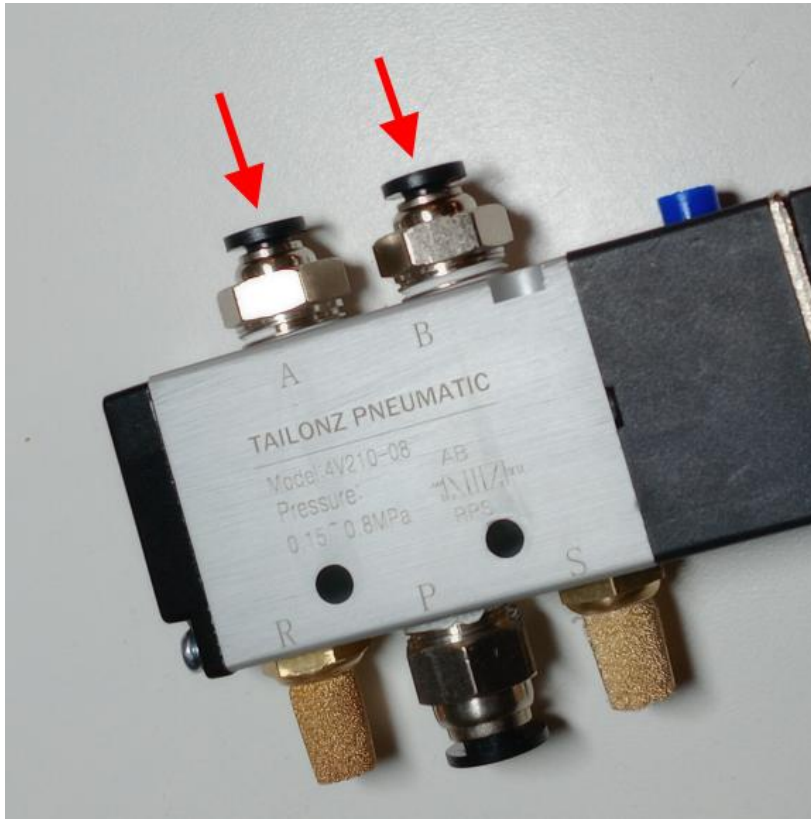

Install (2) 4mm tube push connect fittings as shown (red arrows) in the "A"- "B" ports of the solenoid valve.

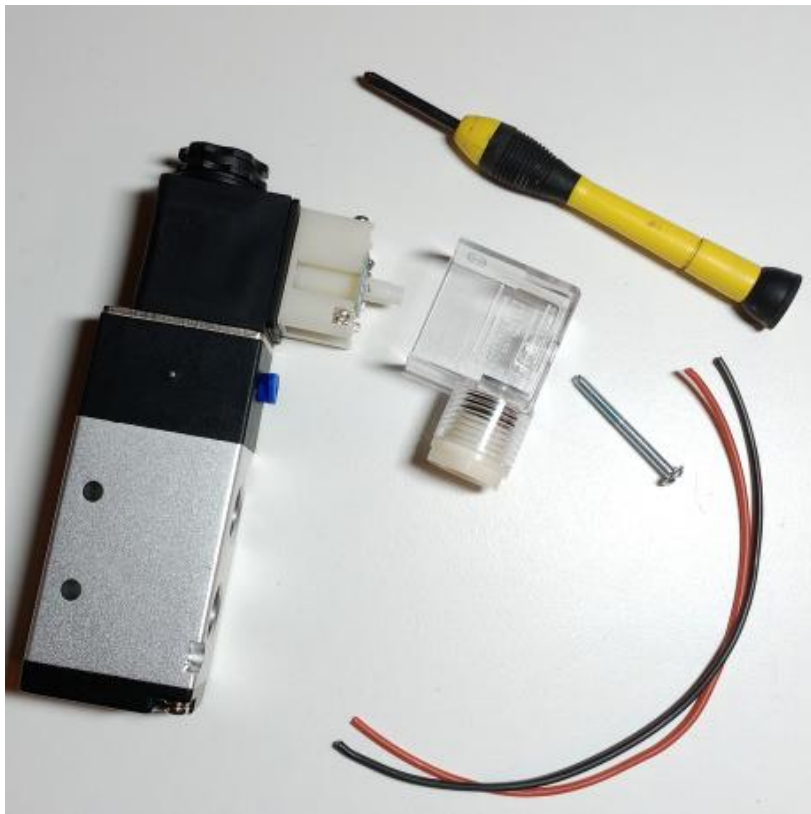

Depending on supply chain availability, your solenoid valve may not have pre-wired pigtail. In this case cut lengths of red / black 20awg wire to a length of 17cm. Remove the terminal cover.

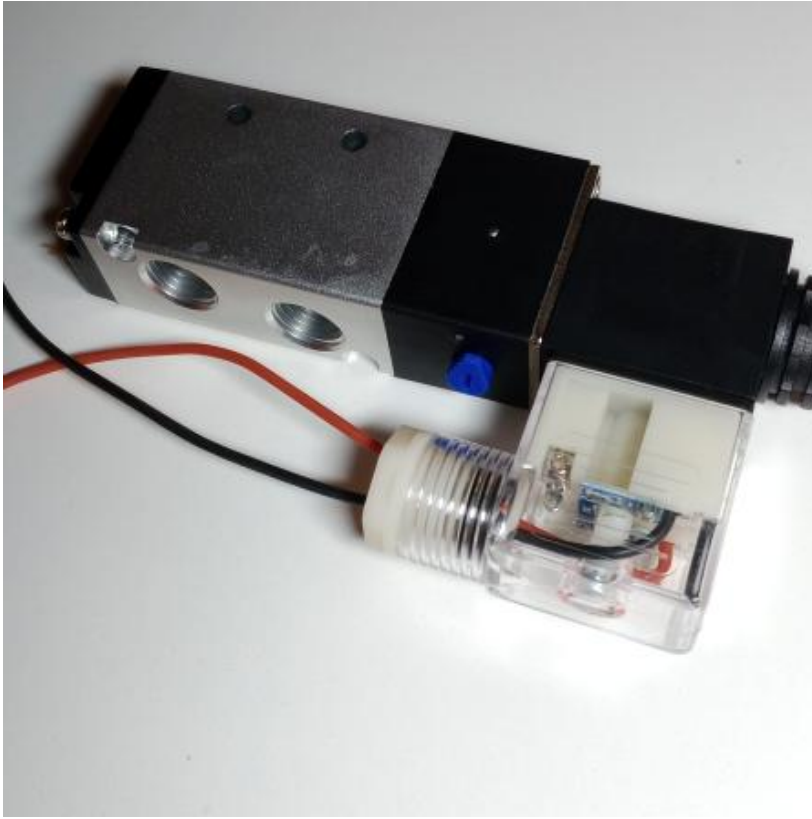

Connect the red wire to the “+” terminal and the black wire to the “-” terminal and then reinstall the terminal cover as shown.

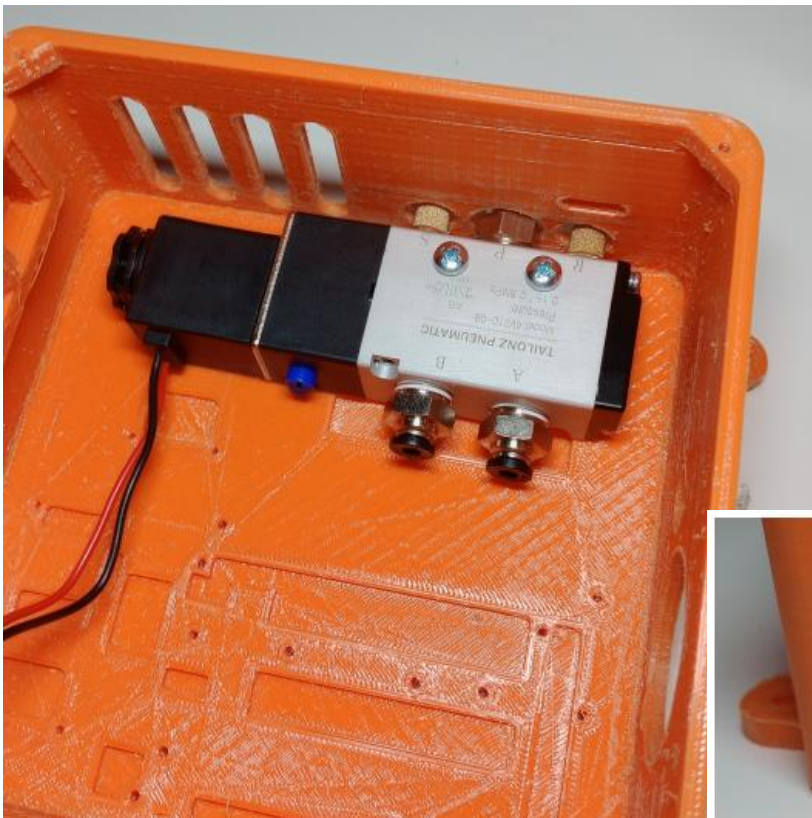

Install solenoid valve into auxiliary enclosure as shown and secure with (2) M4x30 pan head screws.

Solenoid inlet port and air silencers should protrude as shown in photo below.





Cut 25cm lengths of the 20awg 2 conductor black and red wire.

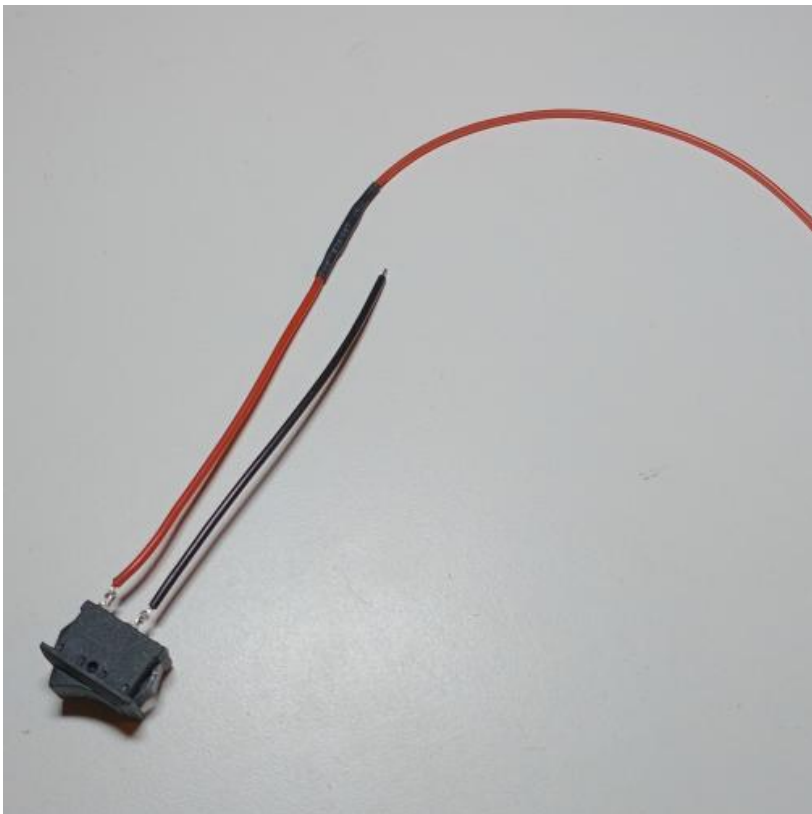

Solder and heat shrink 25cm red wire to extend the rocker switch red wire so that the total length of the red wire is 34cm long.

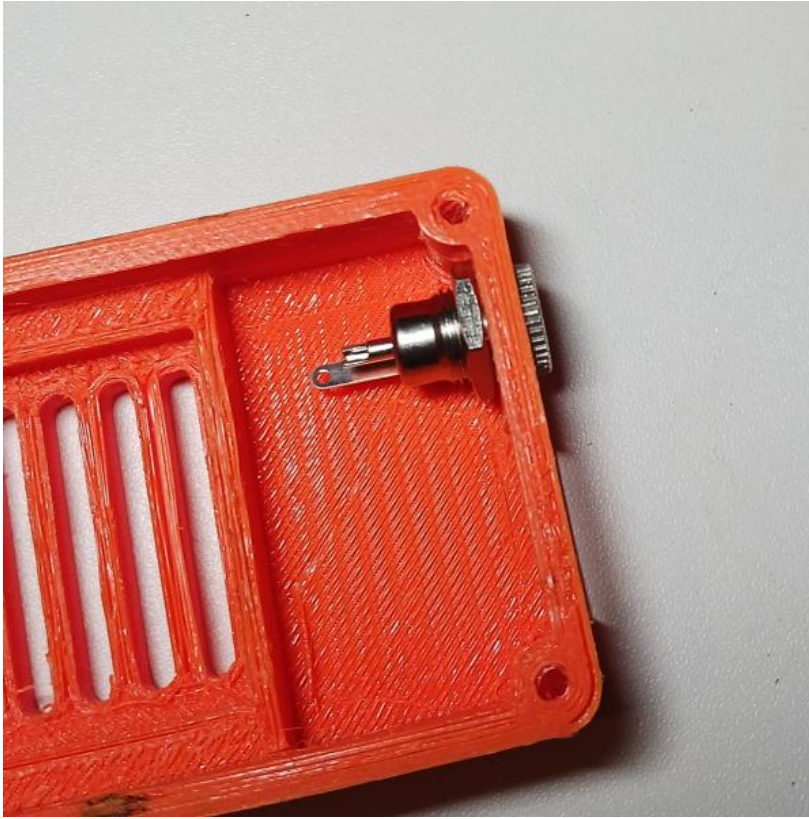

Remove all build structure from 3D printed Base Enclosure Fan Cover then install the 5.5mm power jack as shown.

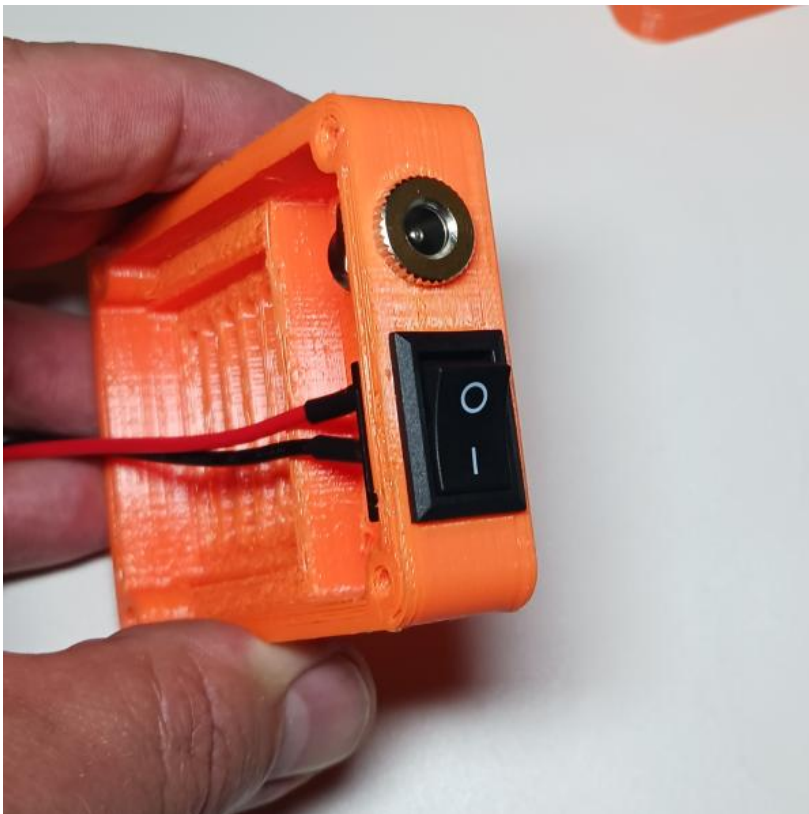

Install rocker switch as shown. Rocker switch will snap into position.

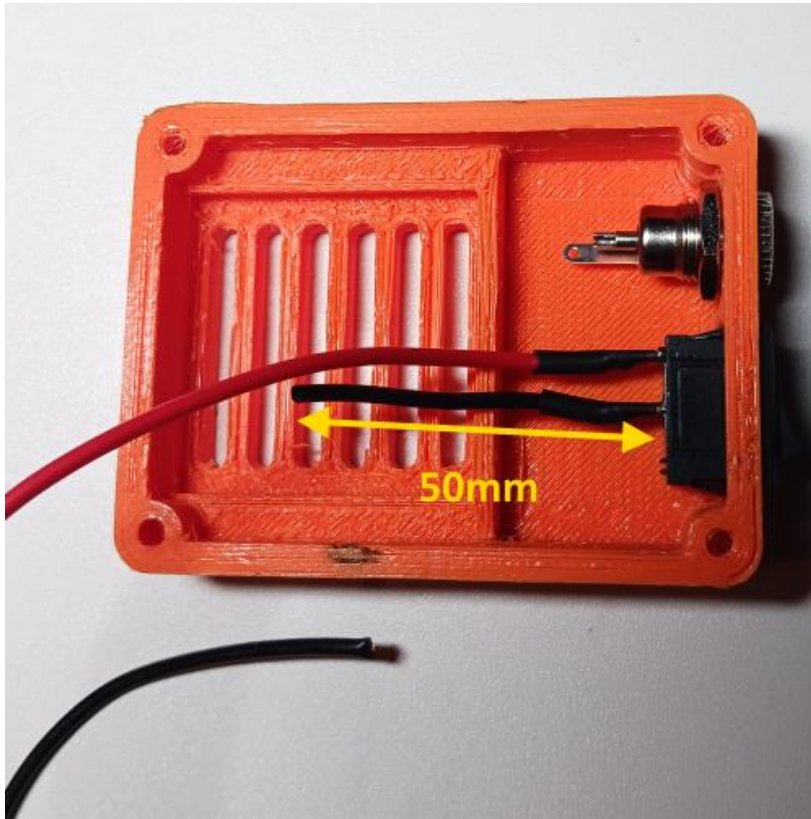

Cut the rocker switch black wire as shown leaving 50mm of wire extended from the rocker switch.

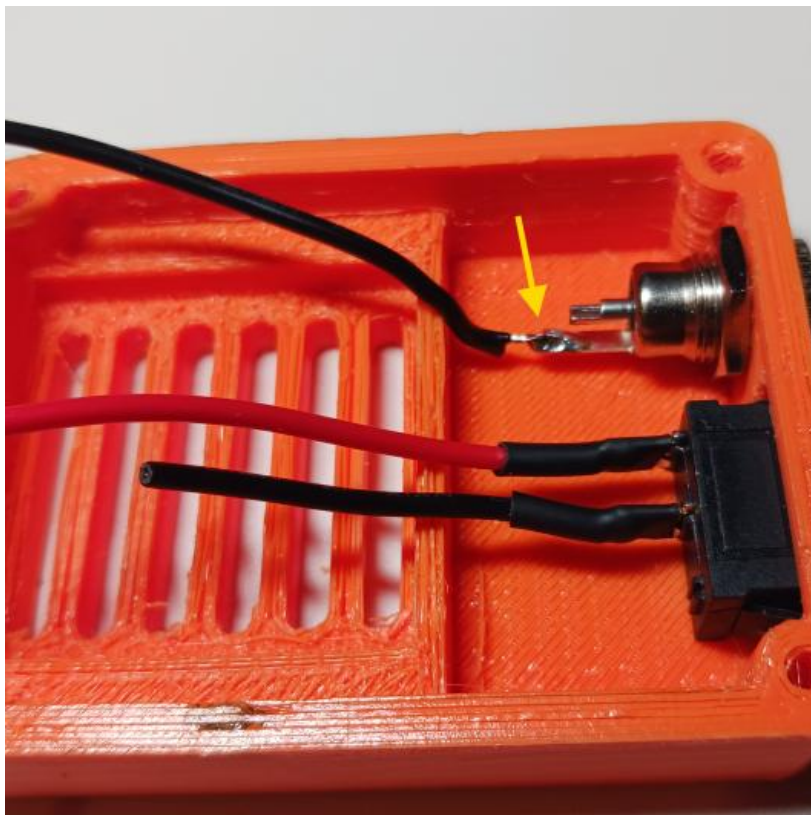

Strip 3mm of sheathing from the end of the black 25cm long wire from step 2 and then solder the wire to the 5.5mm power sockets ground connection tab as shown.

NOTE: The ground connection tab is the longer tab coming from the socket outer housing as shown.

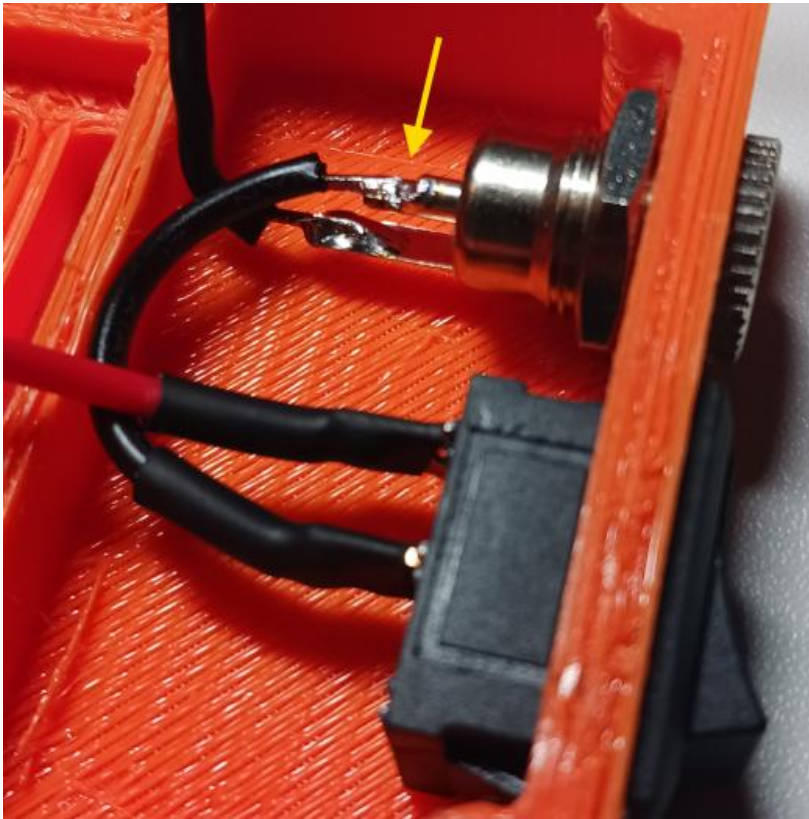

Remove 3mm of sheathing from the rocker switch black wire and then solder the rocker switch black wire to the positive center terminal on the 5.5mm power jack as shown.

NOTE: the positive terminal is the one in the center of the power jack. Make sure solder connections to each of the power jack terminals are solid and that there are no stray strands of wire and that there are no possibilities of a short between the power jack terminals.

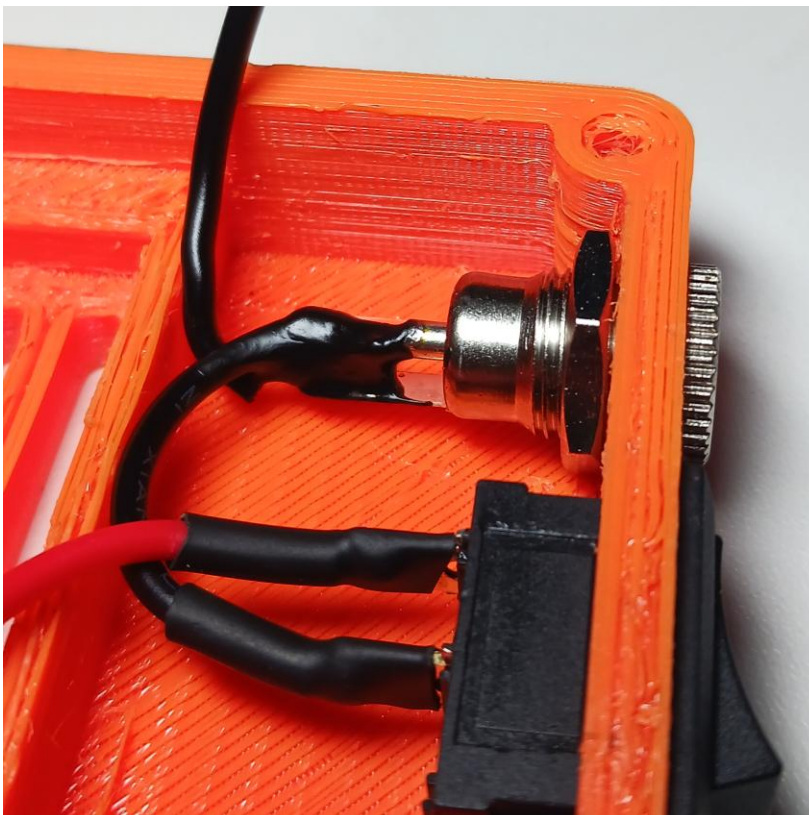

Apply liquid electrical tape to the power jack terminals ensuring there is possibility of a short between the power jack terminals.

NOTE: allow liquid electrical tape to dry and harden completely before moving to the next step.

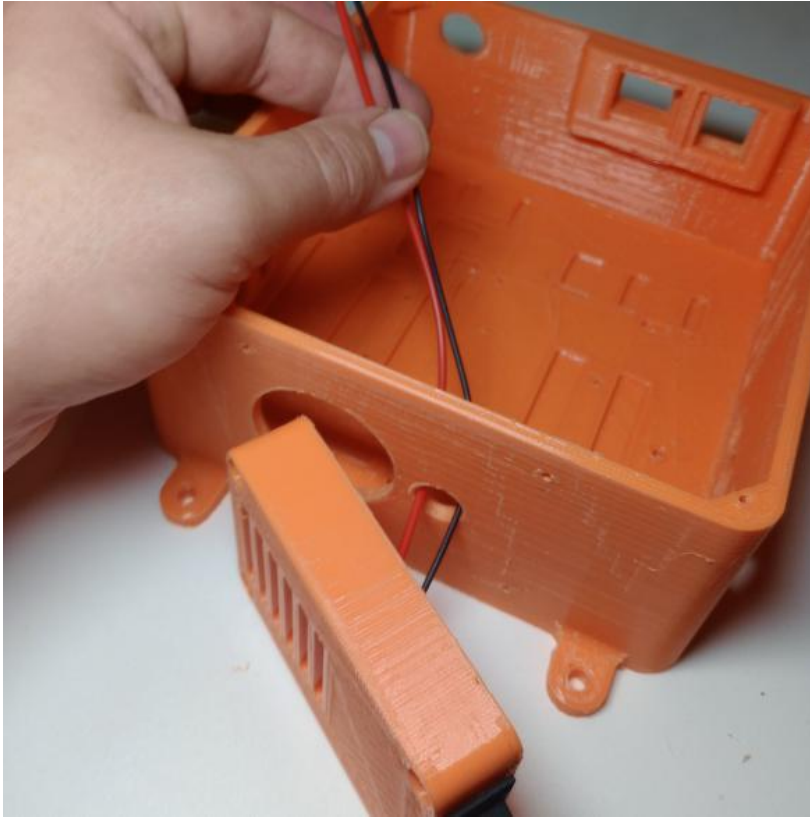

Feed red and black wires through the hole shown in the auxiliary enclosure.

NOTE: A fan is not needed for the pneumatic gripper so the fan recess area can be left empty.

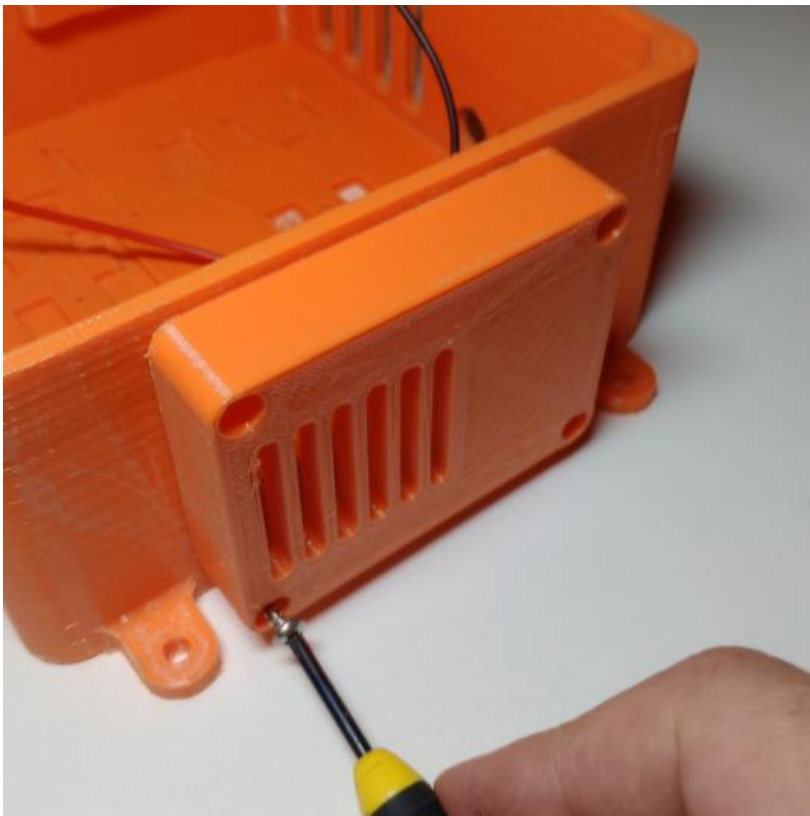

Secure fan switch cover to the auxiliary enclosure using (4) #6 thread form screws.

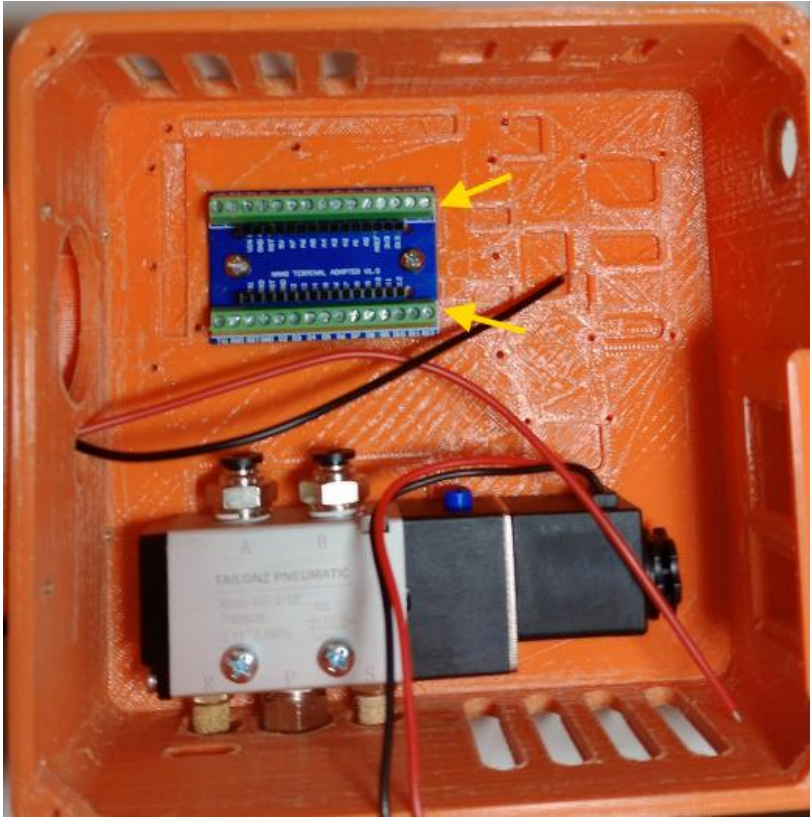

Secure Nano breakout board to enclosure in the position shown and secure with (2) #6 thread form screws.

Make sure to orient the board with the D12 and D13 terminals to the right as indicated by the yellow arrows.

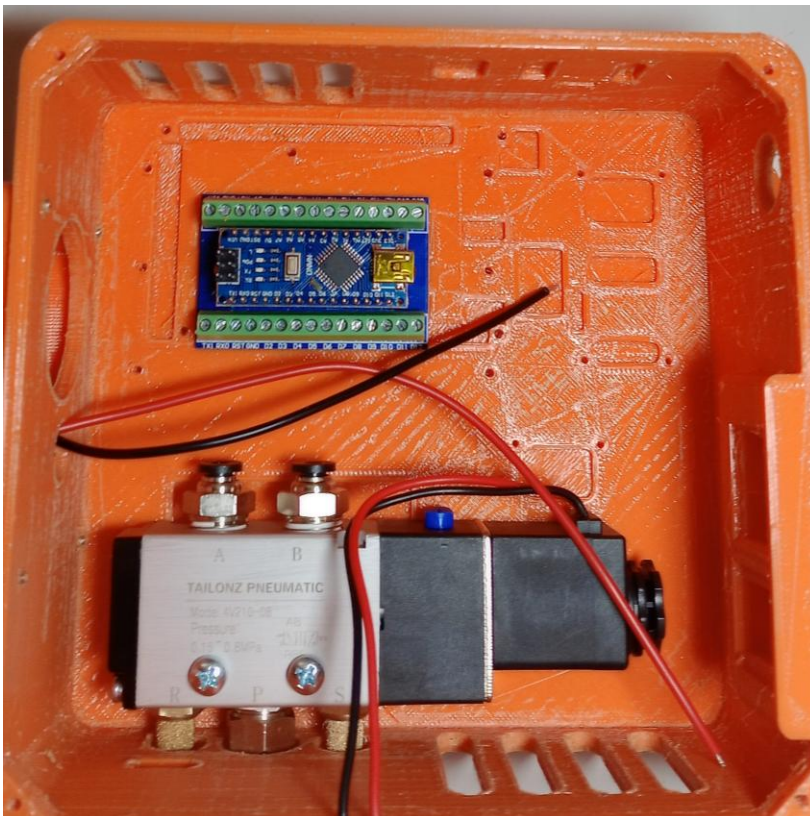

Insert Nano board into terminal breakout board as shown.



Install 5v relay module and secure with (4) #2x.25 screws.

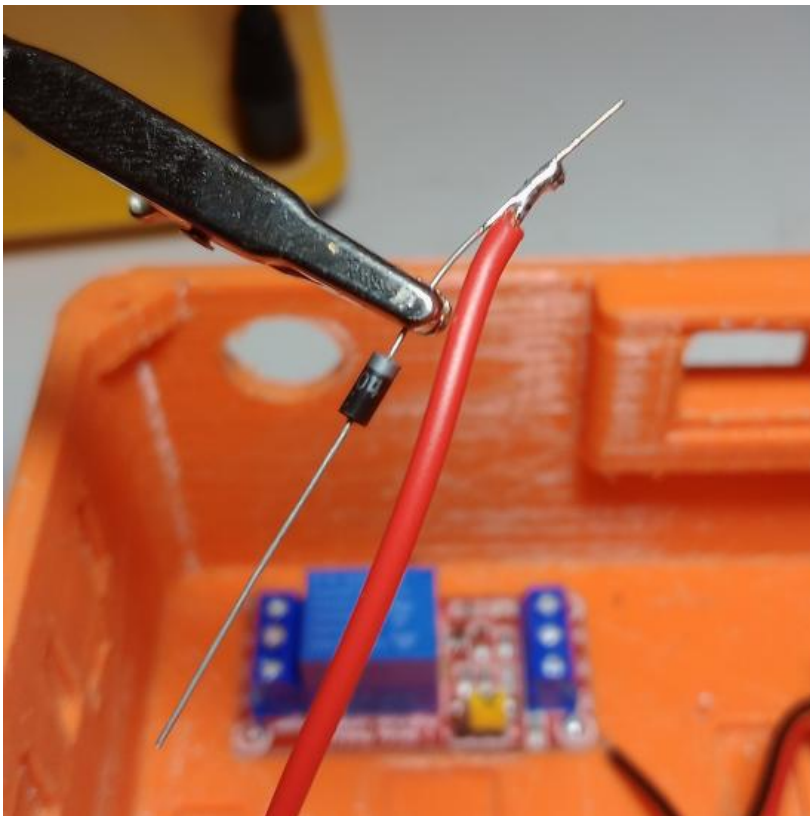

Solder the red wire (coming from fan enclosure) to the 1N4004 diode as shown. Make sure to solder the red wire on the side of the diode that has the silver band.

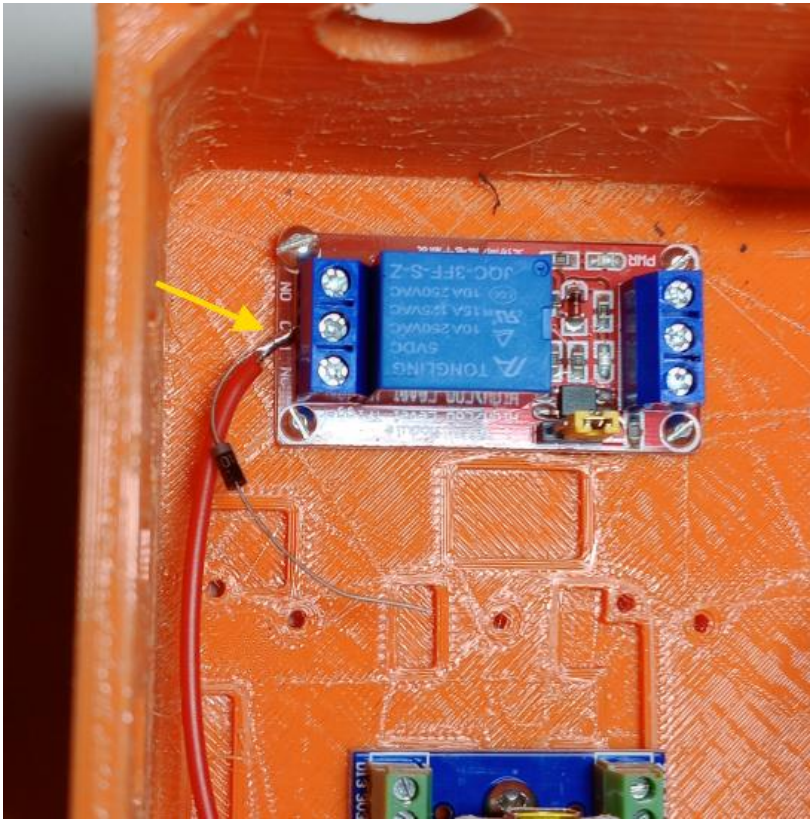

Connect the red wire with diode to the center COM terminal of relay.

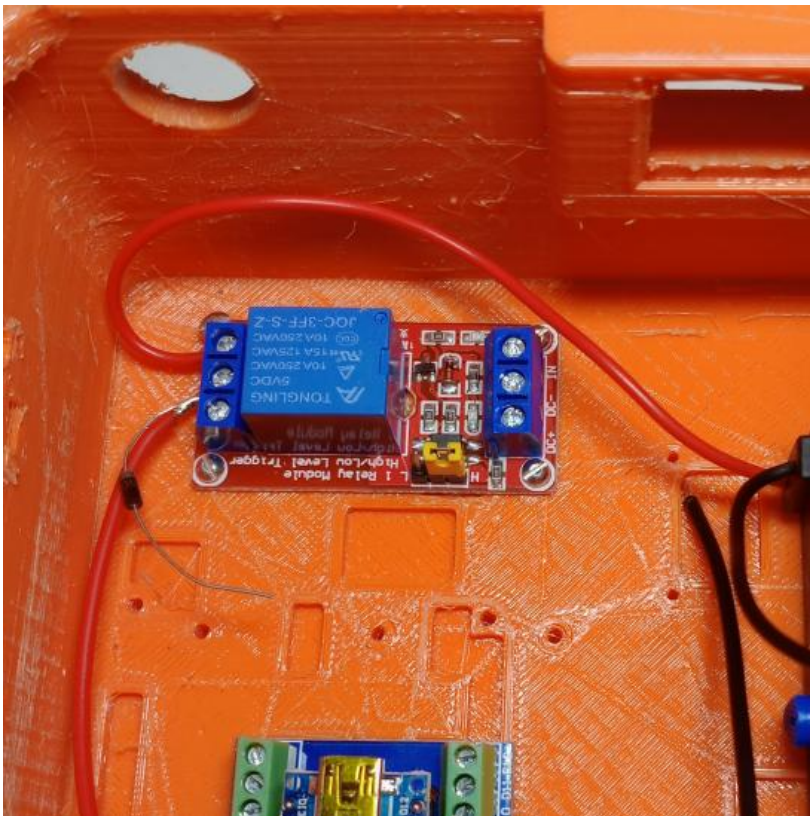

Trim red wire from solenoid valve to length shown and then connect to the top "NO" terminal of relay.

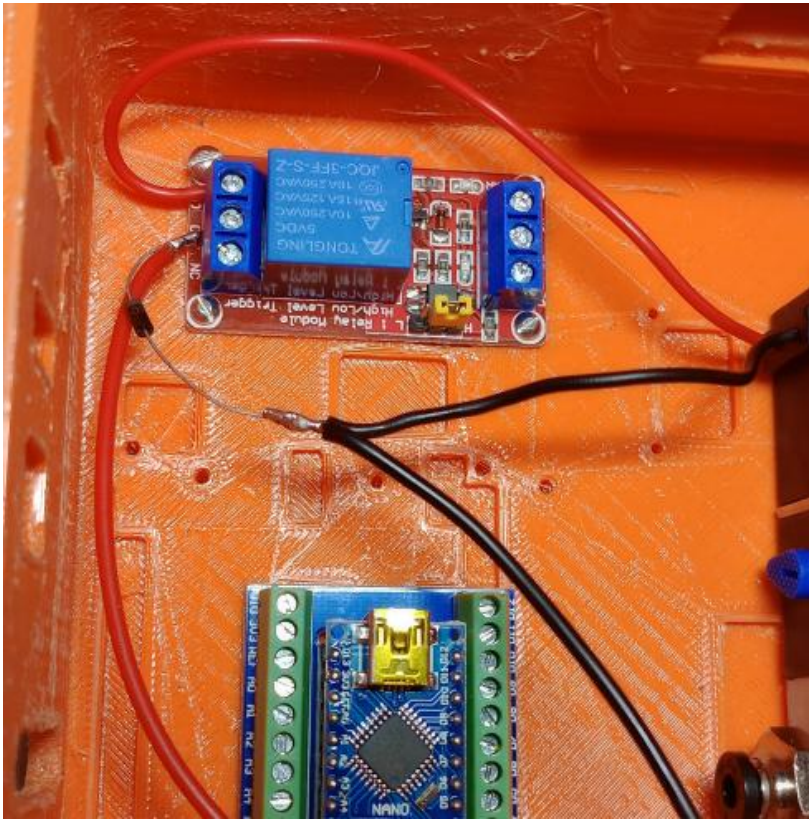

Trim the solenoid black wire to the length shown, then solder the solenoid black wire and fan enclosure black wire together and then solder those to the other end of the diode as shown.

NOTE: the diode serves to eliminate EMF interference when the solenoid actuates. If this interference is not removed the Nano board can drop its connection to your PC each time the solenoid actuates.

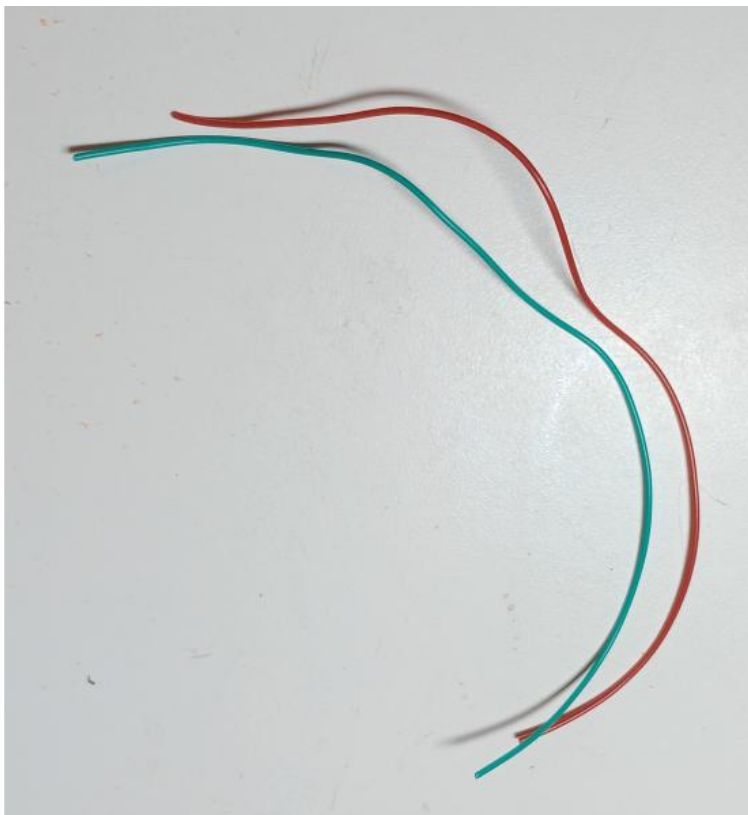

Cut a 20cm length of red and green 22awg wires that was leftover from the J2 or J3 encoder wires that were removed.

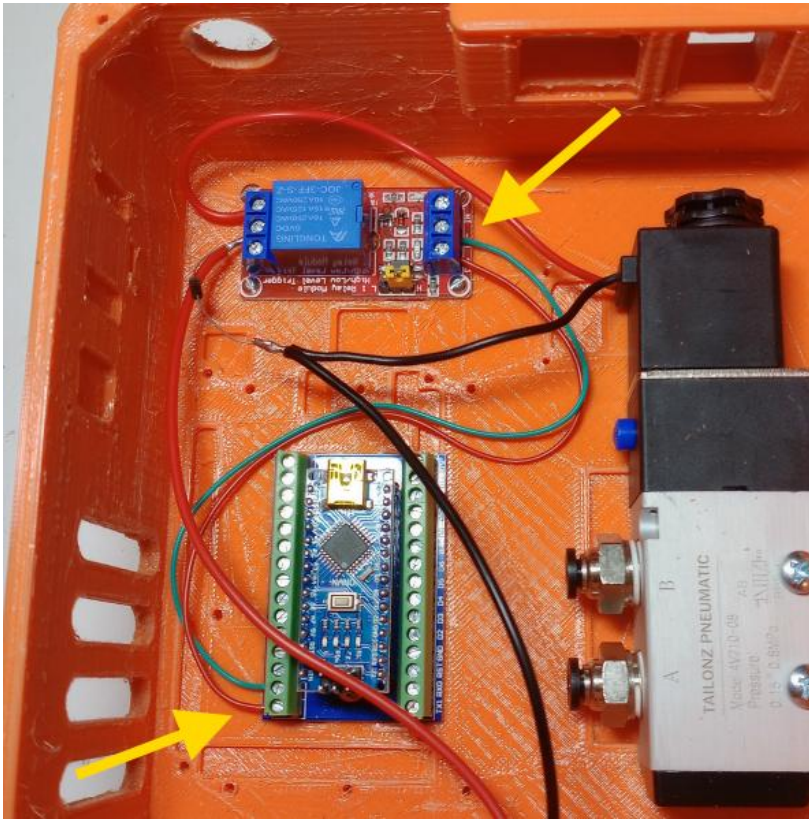

Strip ends of the red and green wires and then connect the Nano board to the relay as follows:

- Red wire from nano VIN terminal to the relay DC+ terminal.
- Green wire from the nano GND terminal to the relay DC- terminal.

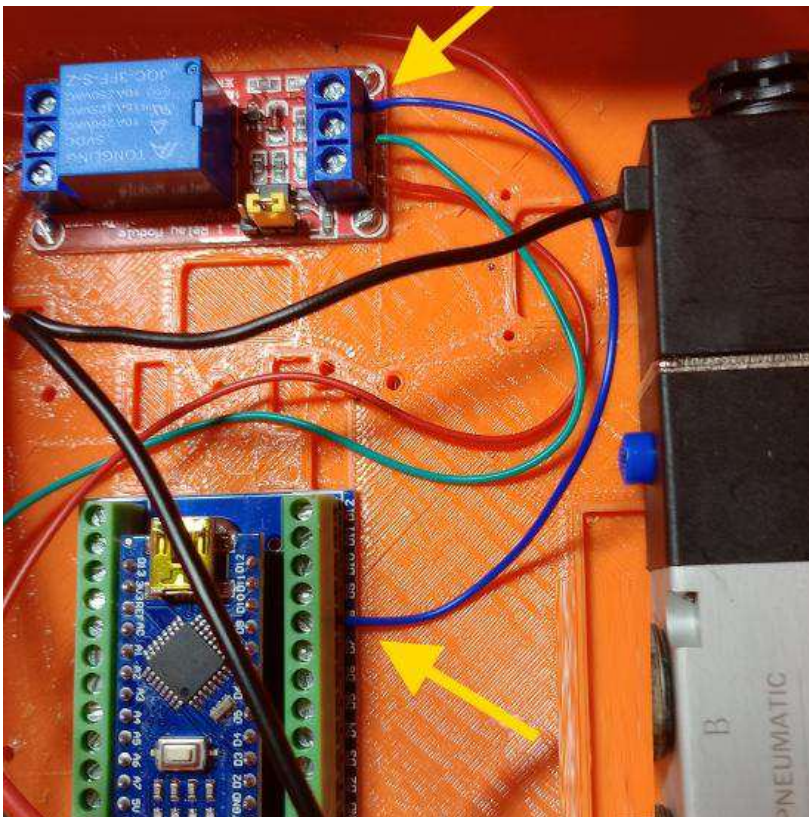

Cut a 15cm length of the 22awg wire that was leftover from the J2 or J3 encoder wires that were removed.

Connect the blue wire from the nano D8 terminal to the relay IN terminal.



Install USB keystone jack into enclosure as shown, then connect USB cable from keystone jack to Nano board.

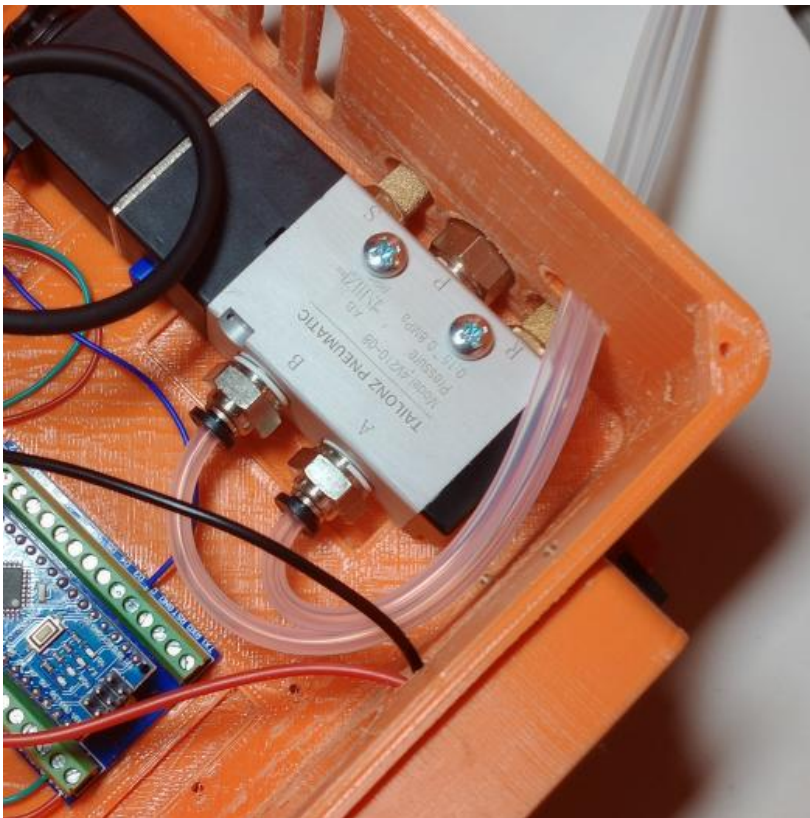

Route pneumatic lines from robot into enclosure as shown and connect to the A and B port push connect fittings.



Install auxiliary enclosure lid and secure with (4) #6 thread form screws.

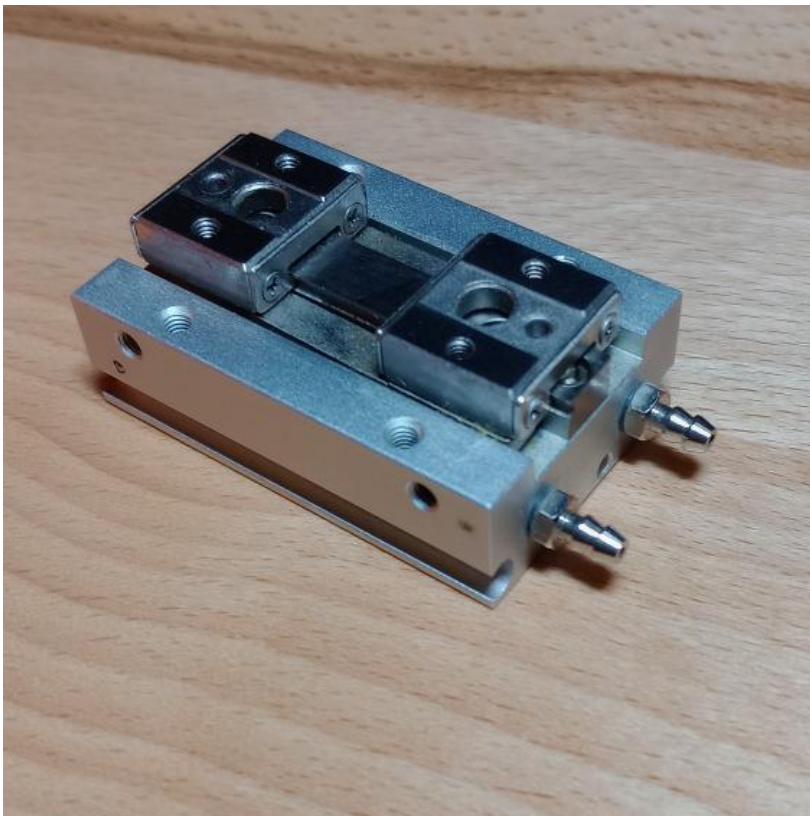

Install 3mm barb fittings to MHF2-8D1 gripper as shown.

NOTE: 3mm push connect or 90 degree fittings can be used if needed.

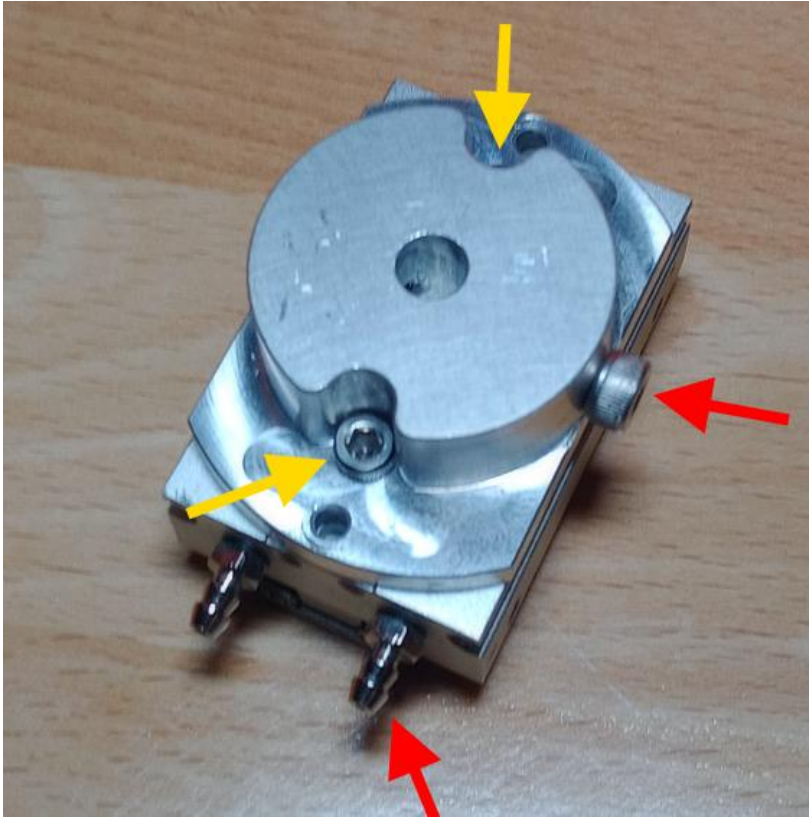

Attach J6 gripper mount to MHF2-8D1 using (2) M3x8 cap screws. (yellow arrows)

NOTE: make sure the M4 timing cap screw on gripper mount is to the right in relation to the barb fittings facing down as shown in photo. (red arrows)

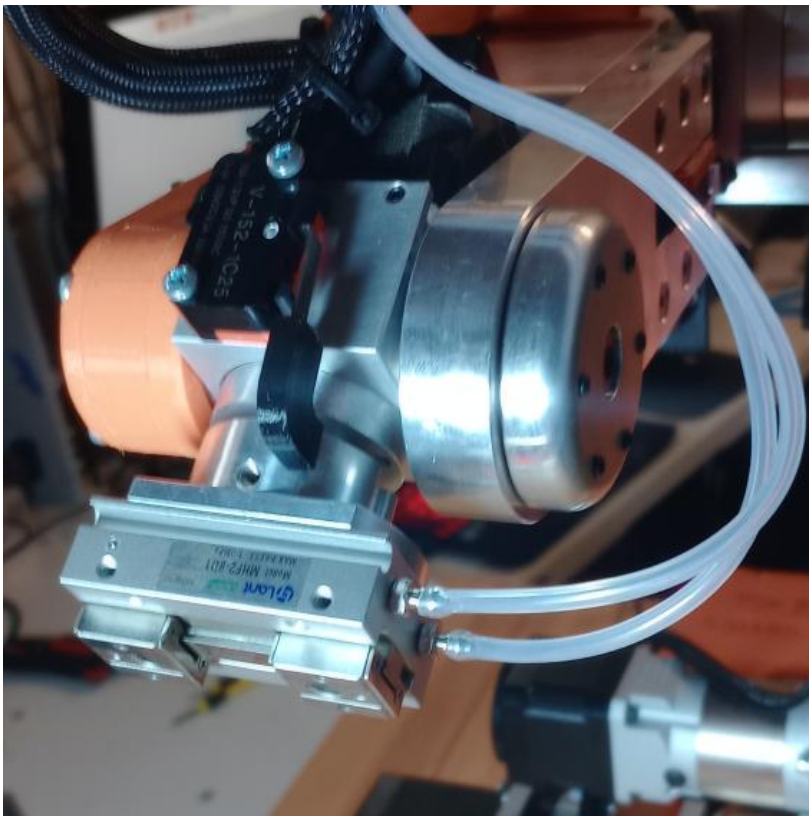

Install gripper and J6 mount onto robot as shown then connect the pneumatic air lines to the barb fittings.

Make sure gripper mount M4 timing cap screw is facing down.

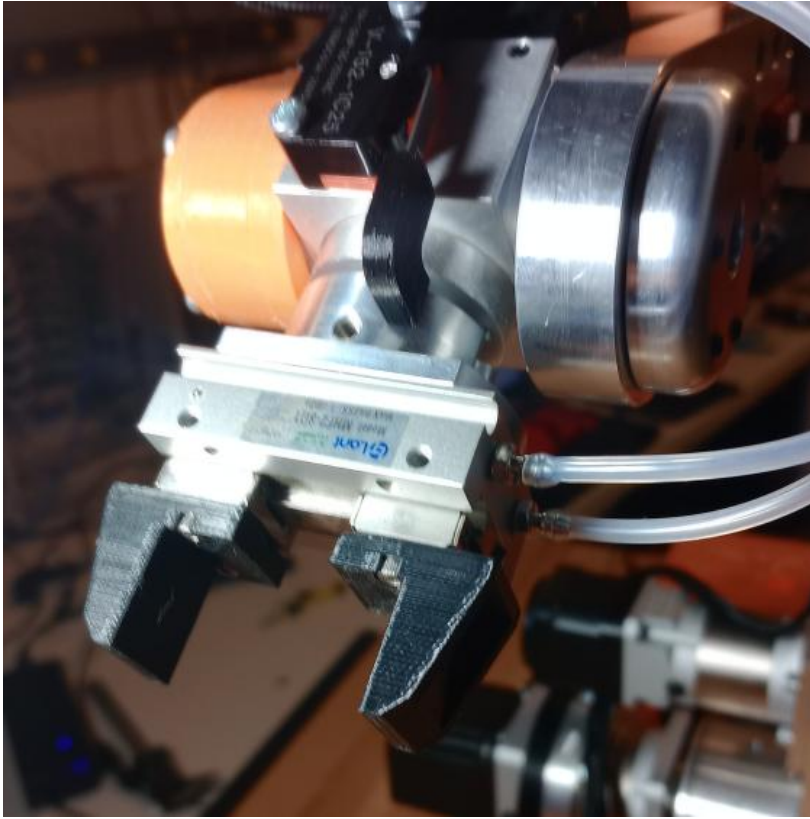

Install gripper jaws on MHF2-8D1 gripper using (4) M2.5x6 cap screws.

NOTE: you can design and install any jaws you require. These jaws are available in the 3D print files.

Open the Arduino software, from the tools, AVR boards menu select the Arduino Nano.

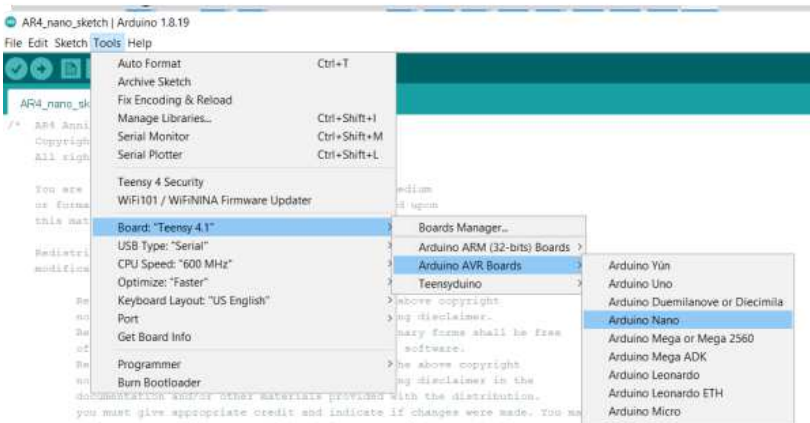

From the tools, processor menu select the (old bootloader) option.

The standard ATmega328 option may work but I have had better luck on most boards with the old bootloader.

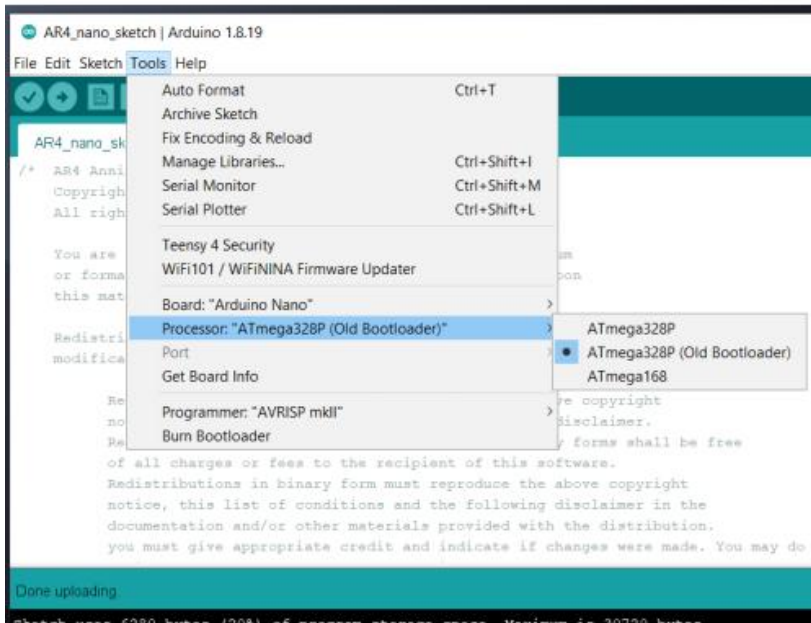

Device Manager

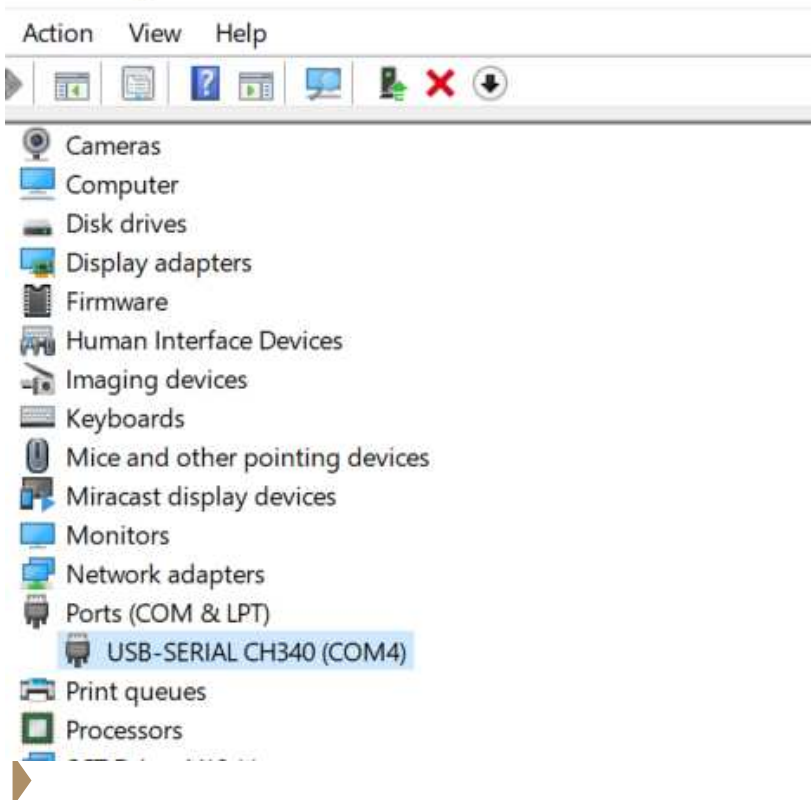

Open your device manager and double check which COM port your nano board connected to. In my case it's the only COM device plugged in at the moment so I know its COM4 but you can unplug and plug it back in and see which COM port updates on the list.

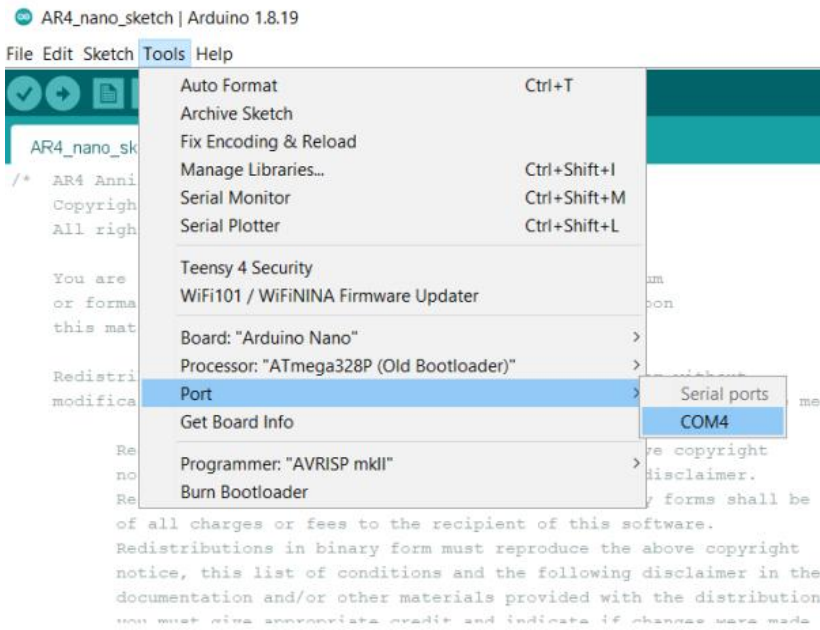

Double check from the tools, port menu that its set to the same COM as your device manager. In my case its COM4.

NOTE: In the AR4 software you will also want to set your Nano COM to this com port.

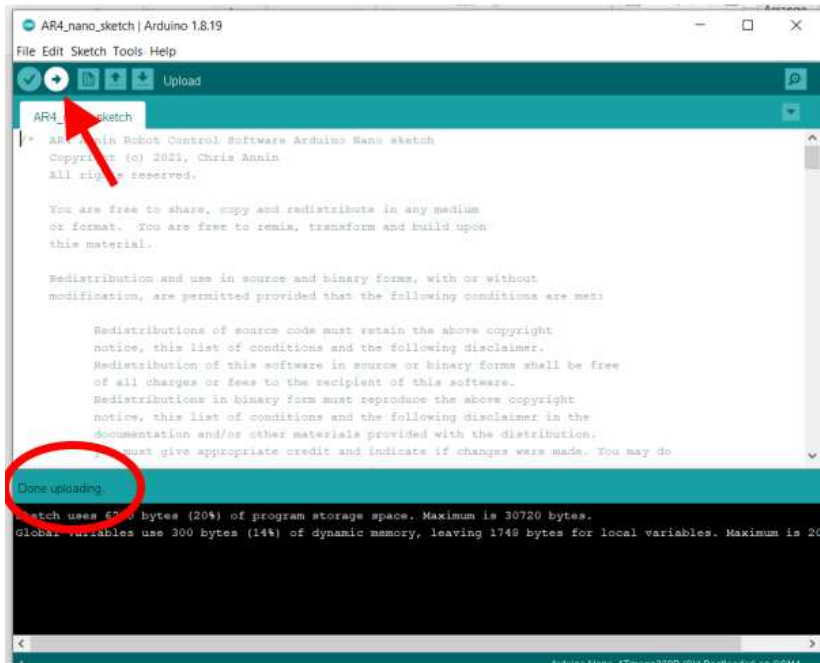

Press the upload sketch button to load the program to the Nano board. It should say done uploading when complete.

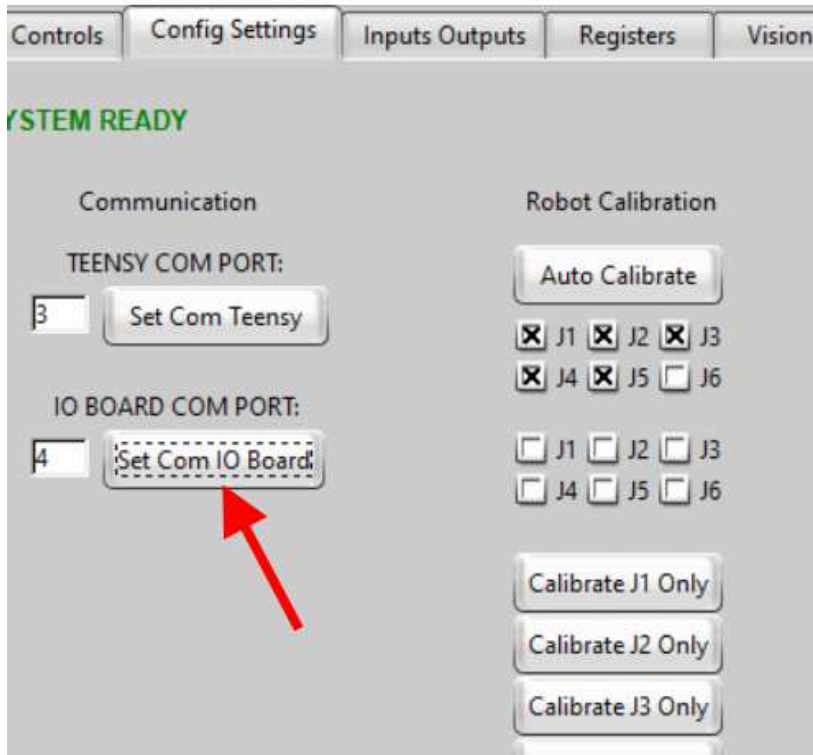

Open the AR4 software, from the config settings tab set the COM port as noted in previous steps to the correct number and then press the Set Com IO Board button.

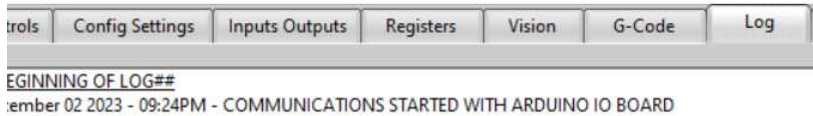

In the software log file it should say communications started with IO board.





Plug 24vdc power supply into auxiliary enclosure and power on solenoid valve.



Connect ¼ or 6mm supply pressure line to air compressor.

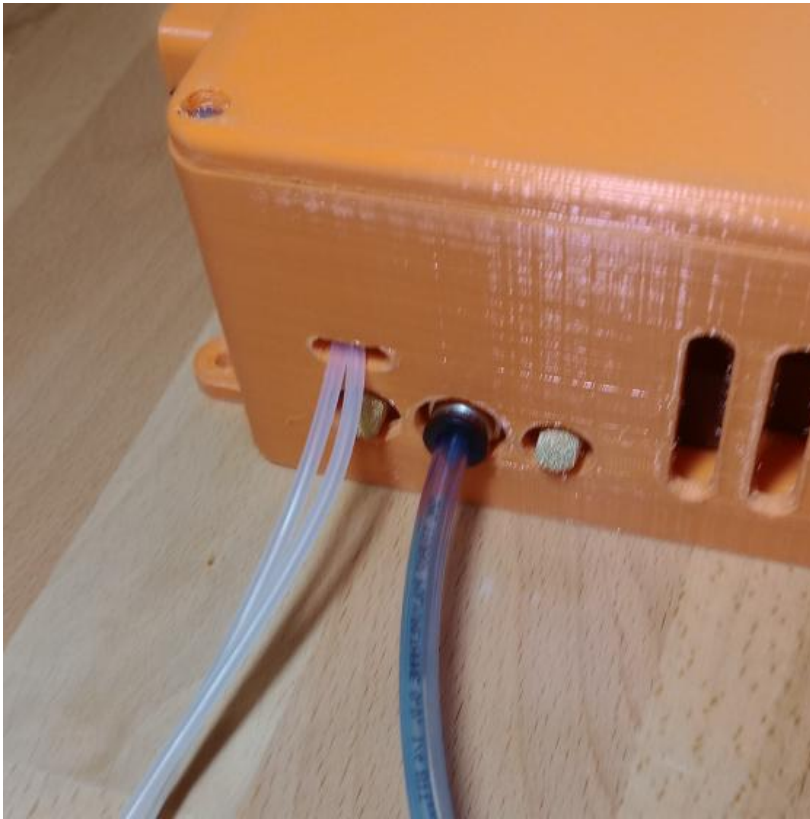

Connect 1/4" or 6mm supply pressure line from compressor to solenoid fitting as shown.

Software Ver 3.3

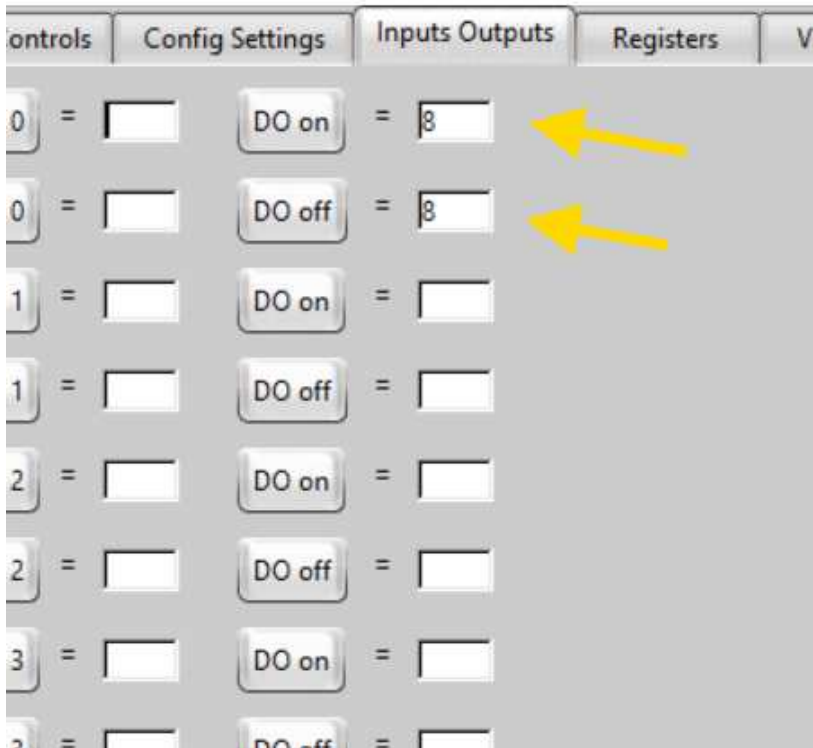

In the AR4 software from the Inputs Outputs tab enter output #8 in the fields shown.

You should now be able to toggle your gripper open and close using the DO on and DO off buttons.

NOTE: you can wire your solenoid valve or additional solenoid valves to any available output. In this example we have used 8 as it's the first available output for the AR4 nano program sketch.

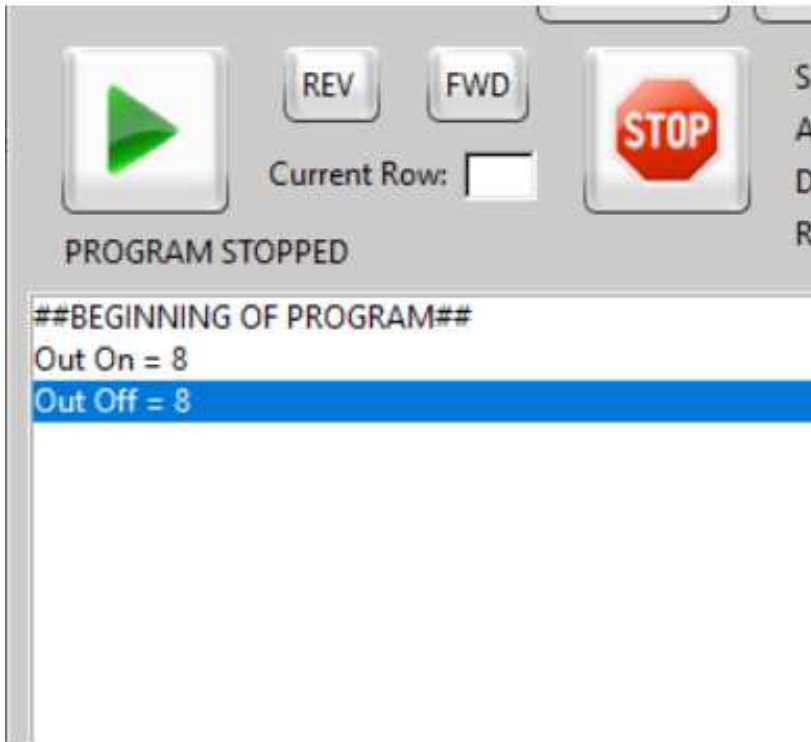

You can control the pneumatic gripper in the robot program using the lines of code shown generated from the “Set Output On” and the “Set Output Off” command buttons.

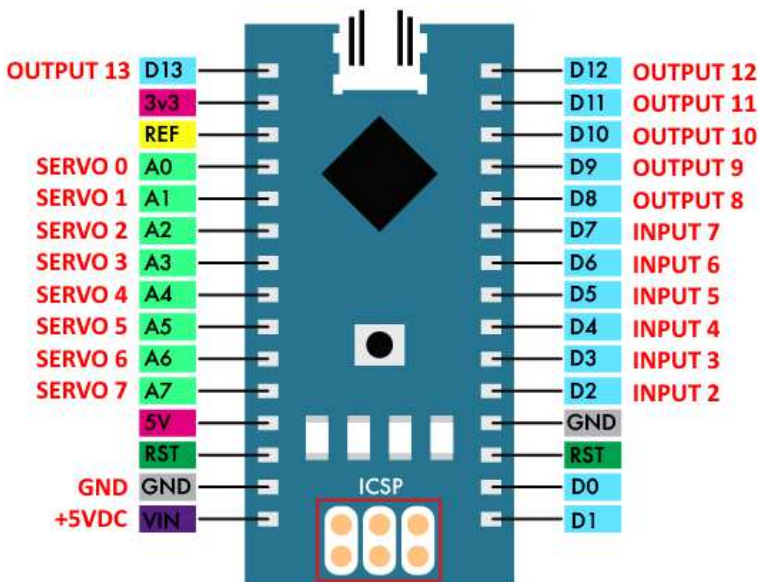

REFERENCE:

The Nano sketch file for the AR4 robot allocates the servo and input / outputs indicated in red text in the diagram shown.

Using the Nano you can control up to 8 servos, 8 digital outputs and monitor up to 8 inputs.

Note the Arduino Mega board can also be used if additional IO is required for your project.

CHAPTER 5

SERVO GRIPPER

The robot can have multiple different end effectors depending on your needs. This chapter covers the installation of an electric servo gripper.

Please also see the tutorial video on grippers and IO connections:
<https://youtu.be/76F6dS4ar8Y>



Servo Gripper Bill of Materials



25kg Servo Gripper – DS3225

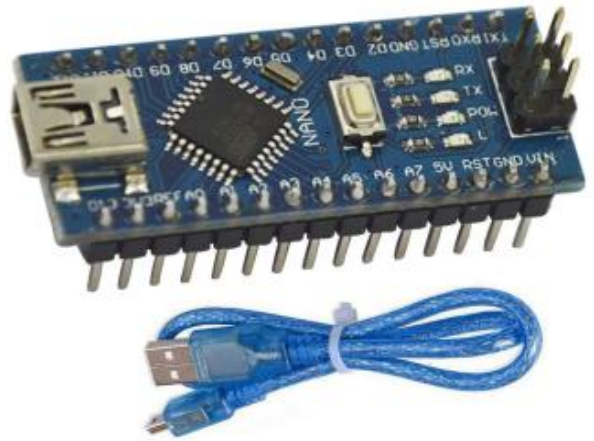

Arduino Nano control board (Arduino Mega can also be used)

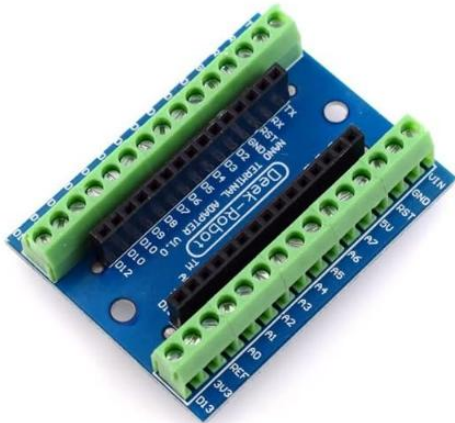

Terminal Adapter Expansion Board for Arduino Nano



Micro USB to USB C Cable

-

Any short length Mini to C cable can be used.



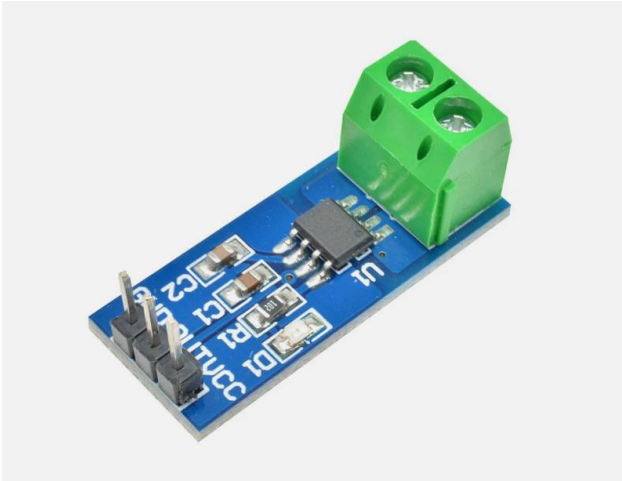

ACS712 5amp current sensor



23cm length 1/4 braided sleeve



Dupont 2.54 mm female 3 pin connector lead.

Qty(1)





5V 3A Power Supply Adapter



20awg 2 conductor black and red wire..
162cm

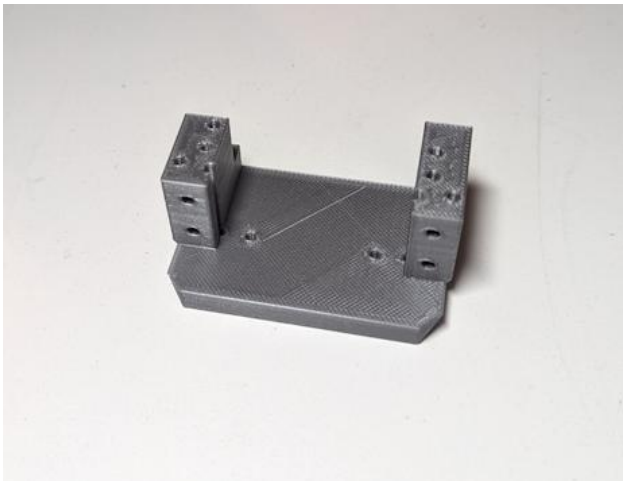

AR4_SG1_base
(3D print – PETG 50% infill)

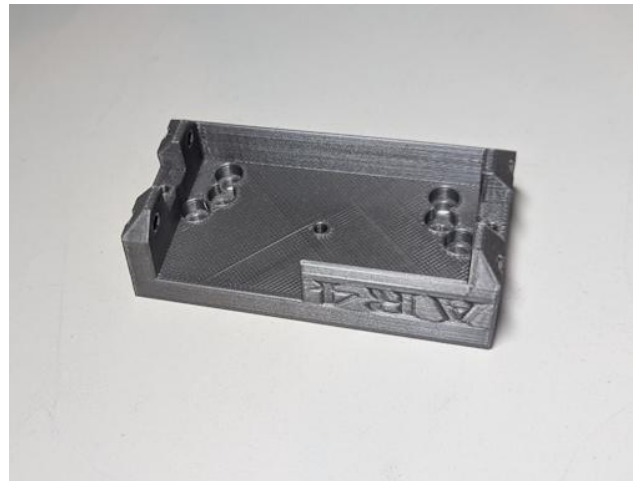

AR4_SG1_carriage
(3D print – PETG 50% infill)





AR4_SG1_center_bar
(3D print – PETG 50% infill)

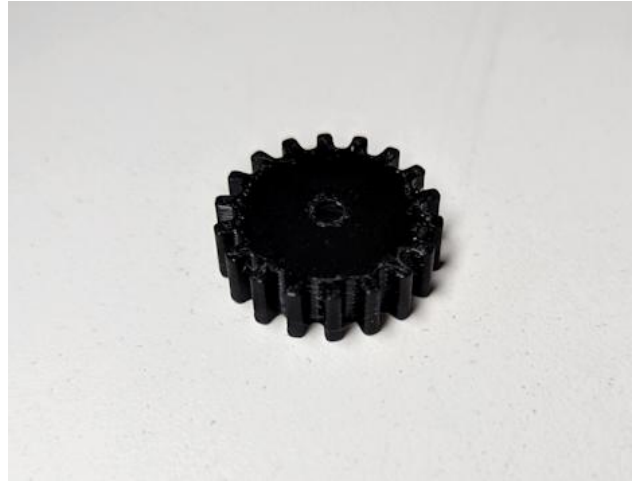

AR4_SG1_gear
(3D print – PETG 50% infill)

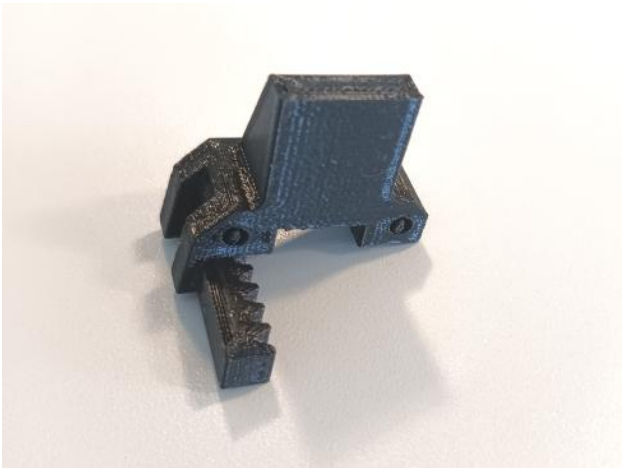

AR4_SG1_jaw1
(3D print – PETG 50% infill – 5 layer walls)

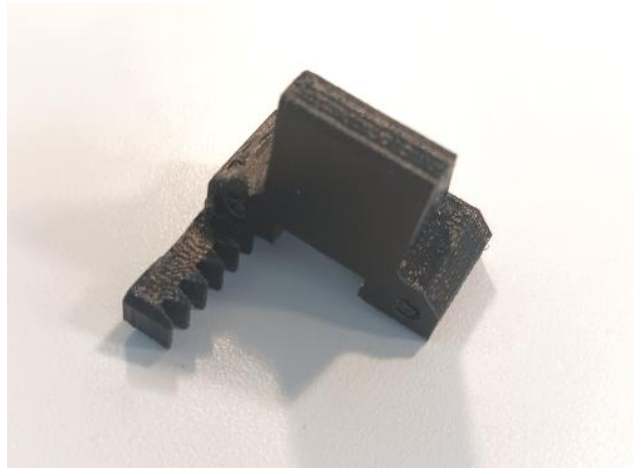

AR4_SG1_jaw2
(3D print – PETG 50% infill – 5 layer walls)





USB-C Keystone Jack.

-

This can be either straight or 90 degree.



5.5mm DC power jack socket.



(x2) 3mm stainless rod cut to length of 70mm



3mm stainless rod cut to length of 16.5mm



Servo Gripper Assembly

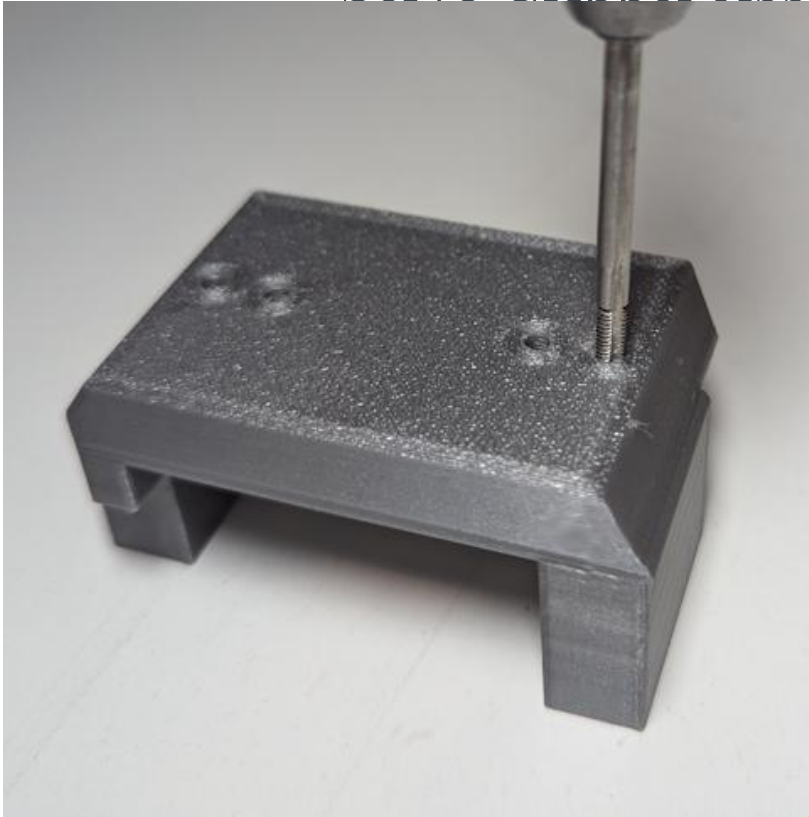

Tap the (4) bottom holes on the gripper base with M3 tap.

Apply light oil and tap hole slowly by hand, do not attempt to power tap with drill.

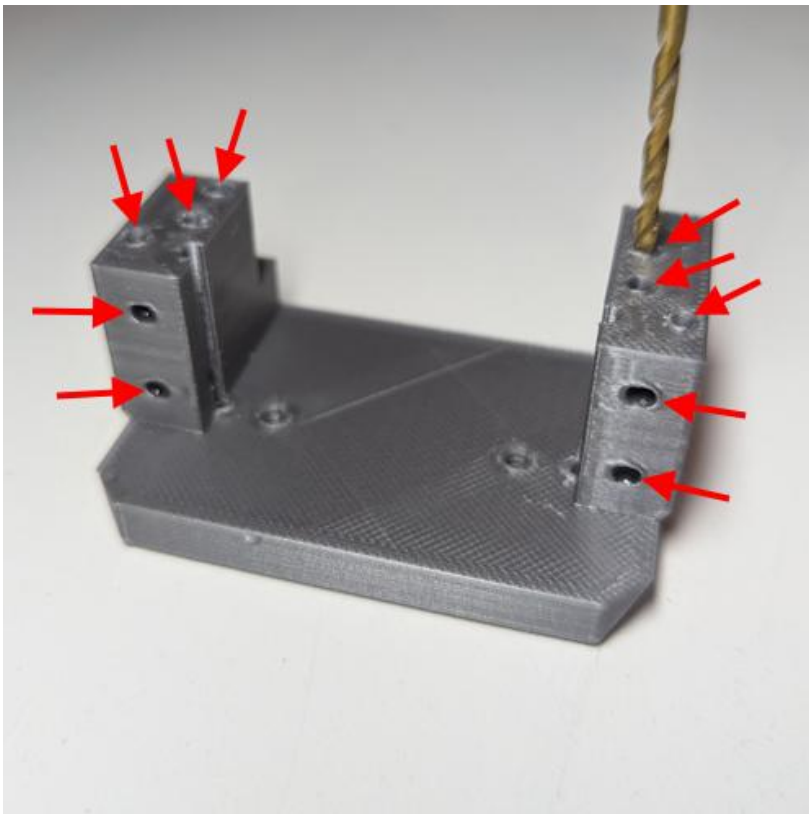

Use 2.5mm drill bit to clear out each of the 10 holes shown in photo.



Secure servo to base assembly as shown and secure with (4) #6 screws

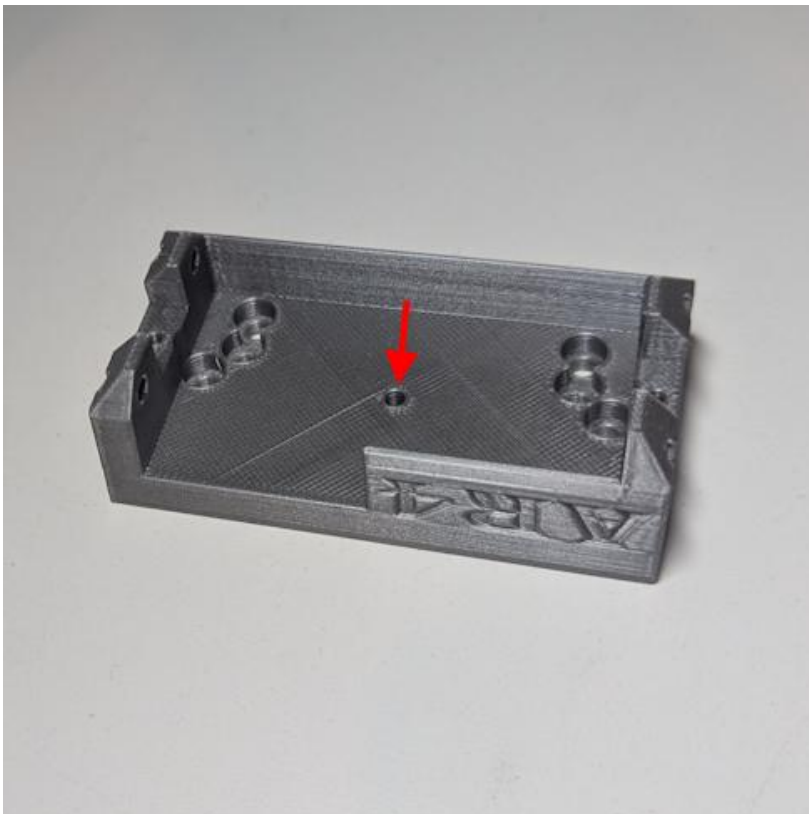

Use 3mm drill bit to clear center hole in 3D printed carriage.

I recommend running the drill in reverse and pushing the drill bit through the hole in reverse. This will prevent the drill flutes from cutting or removing too much material – we want the 3mm pin to be a tight or slight press fit.



Insert 16.5mm long shaft into carriage center hole and press down into place. Shaft need to be fully inserted flush to bottom surface of carriage.

NOTE: the shaft should be a tight or slight press fit. If the shaft is loose or comes out easily you can apply a small amount of super glue on end of shaft.

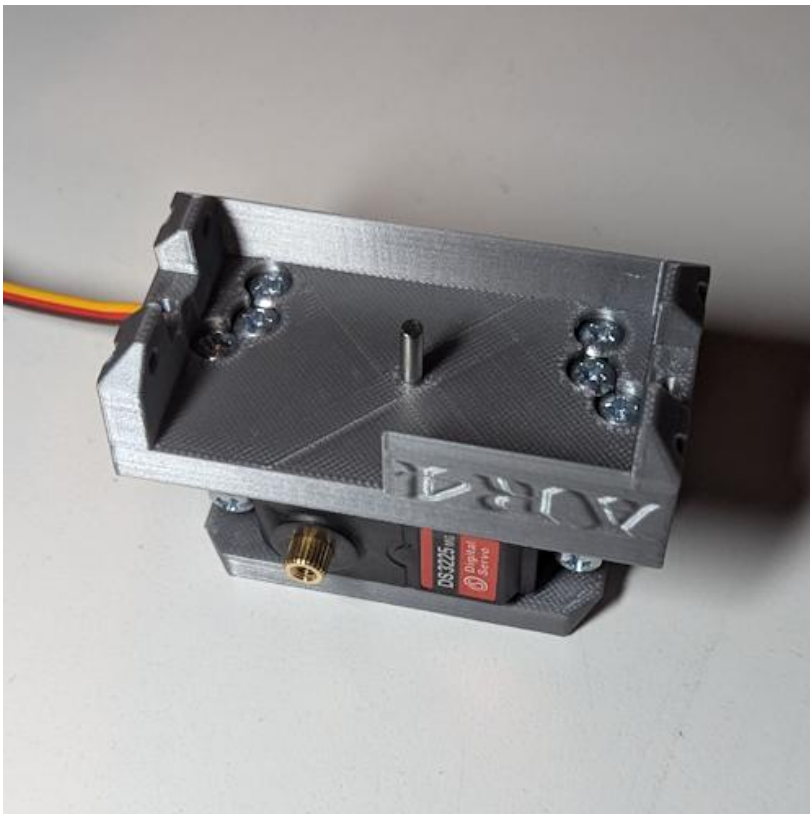

Secure carriage to base as shown with (6) #6 screws.



Use 3mm drill bit to clear center hole in 3D printed gear.

Run drill bit in forward direction when clearing hole. The gear should spin freely on 3mm shaft.

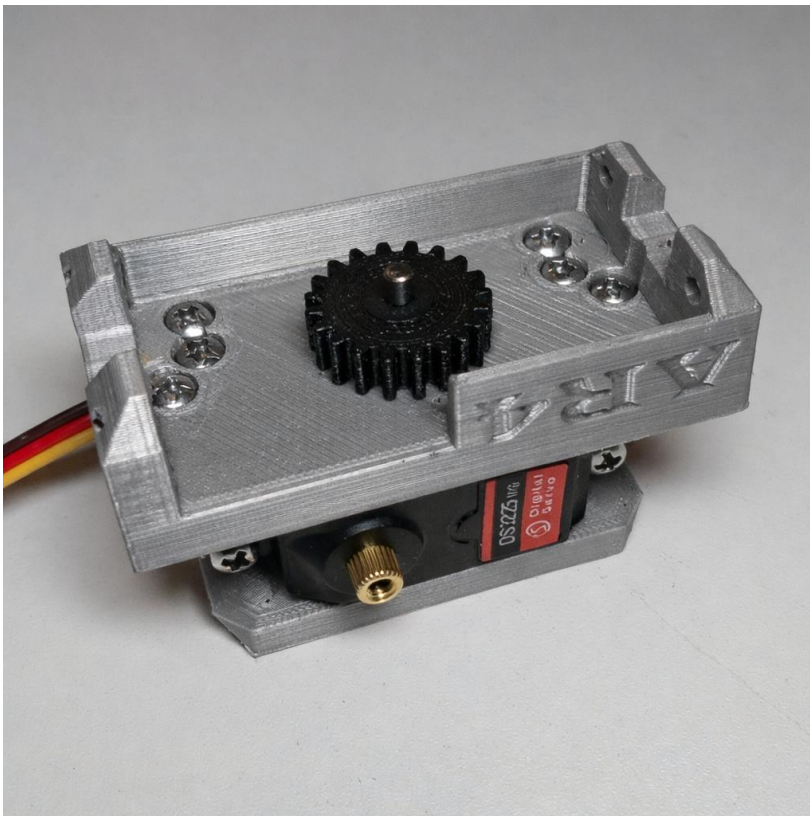

Install gear on center post and make sure it spins freely.

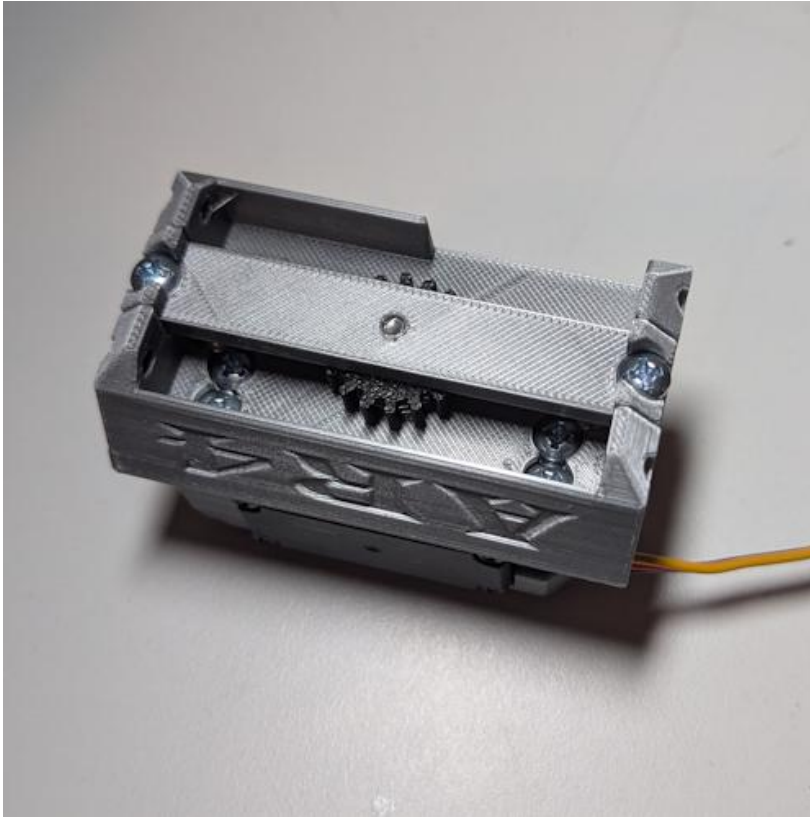

Install center bar and secure with (2) #3 screws as shown.



Use 3.2mm drill bit to clear both rail holes in the 3D printed jaw1 and jaw2 parts.

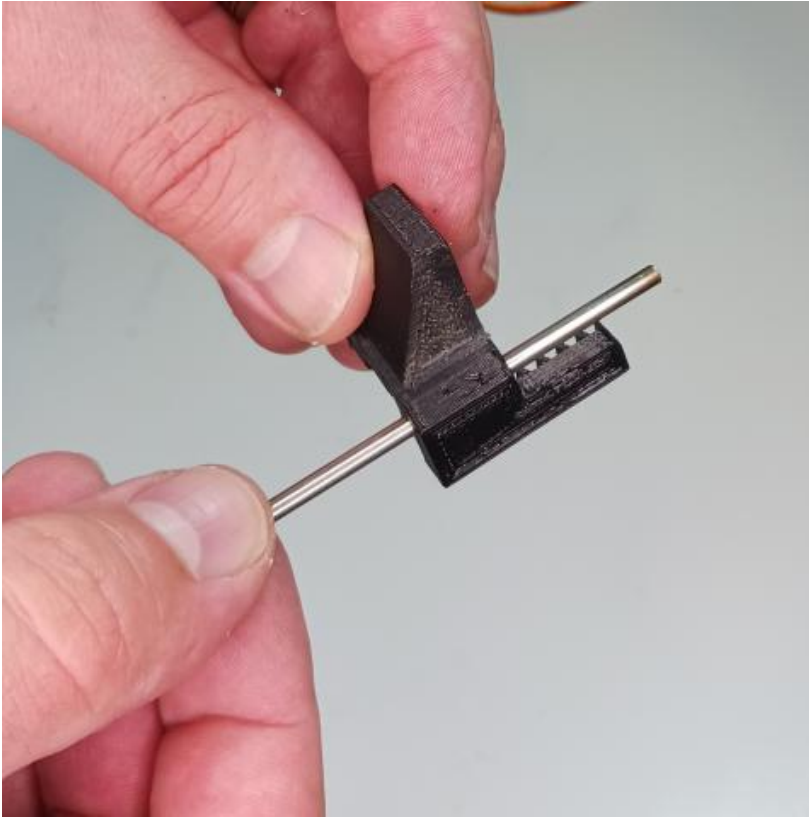

Make sure 3mm rod slides easily in each jaw rail hole.

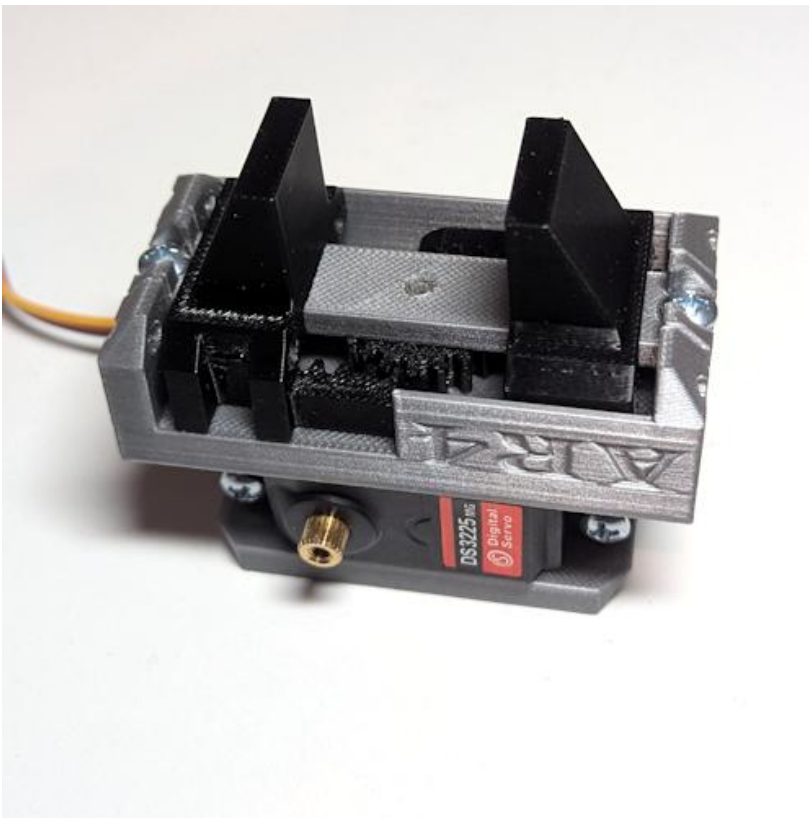

Install jaw1 and jaw2 as shown. Make sure the jaws slide easily.

Make sure to clean all 3D printed parts, remove any positives or imperfections, use flat file and square file to carefully clean or polish all flat surfaces and make sure all parts move and slide freely.

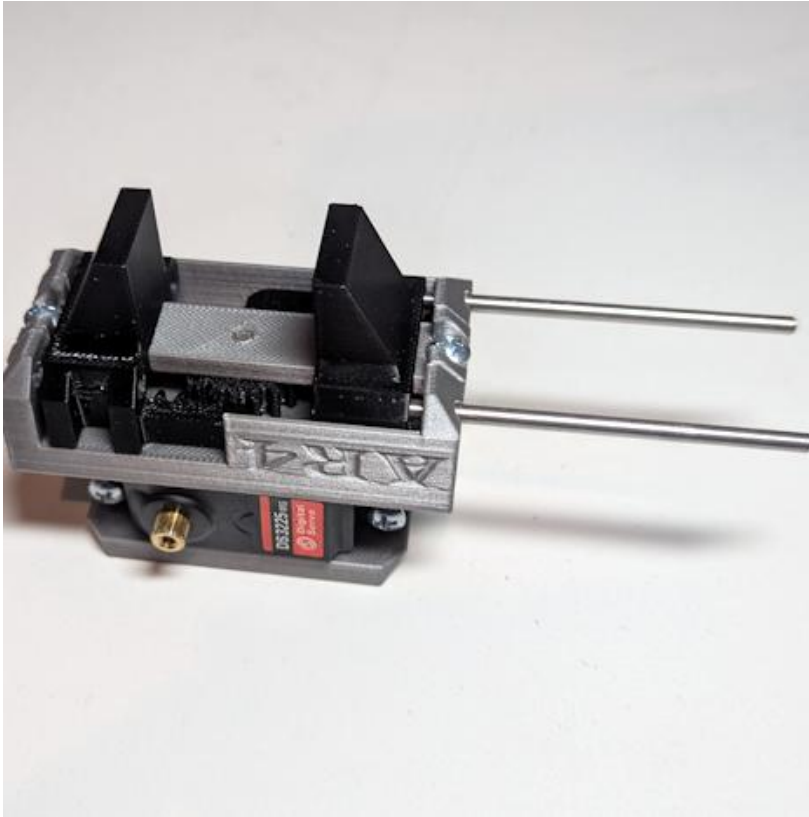

Use 3mm drill in reverse to clear end holes in carriage and then insert the (2) 70mm rods through carriage and through jaw rail holes as shown.

NOTE: The rods should be a tight fit through the carriage.

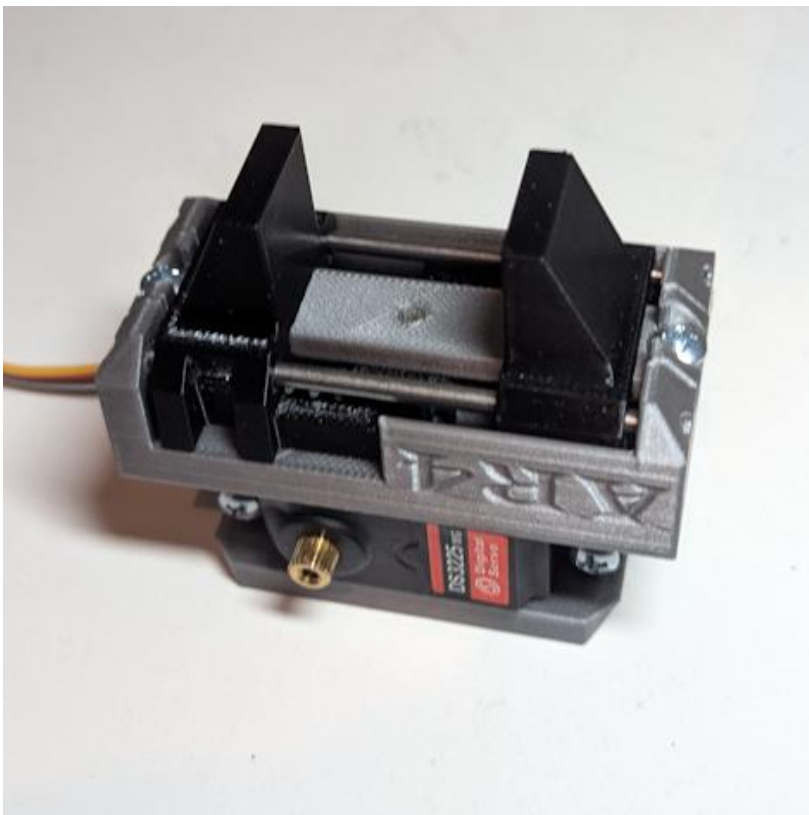

Finish inserting rods through the other jaw and into other side of carriage.

If you have any issues with the rods coming out or sliding out of carriage too easily you can place a small amount of super glue at each of rod to secure in position.

Make sure jaws slide easily.

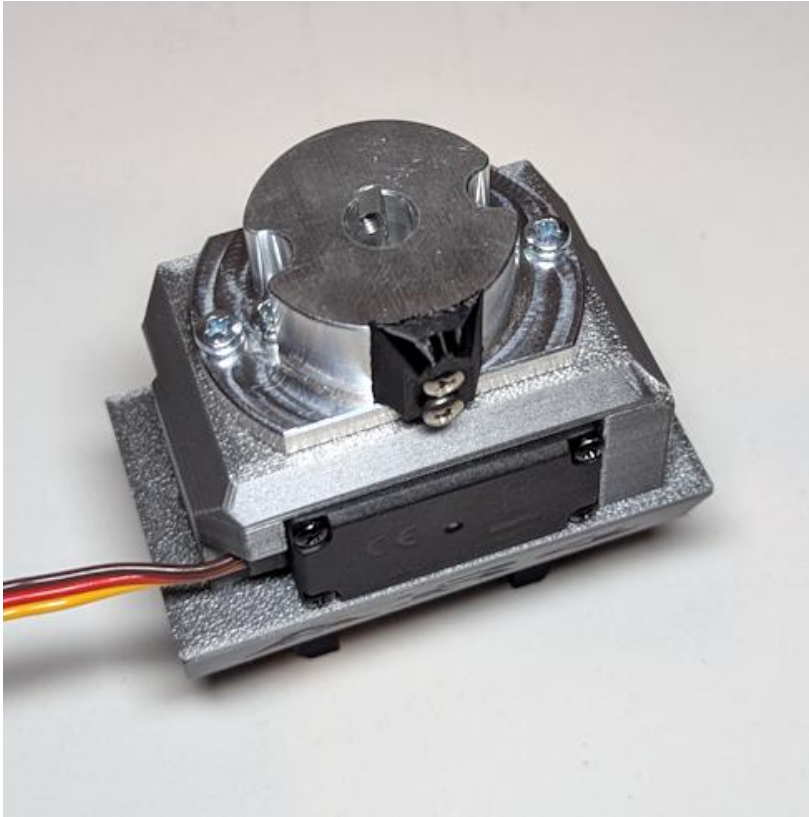

Install J6 gripper mount onto gripper assembly as shown and secure with (4) M3x10 pan head screws.

Make sure the gripper limit switch contact is facing the back of the servo when installed as shown in photo.

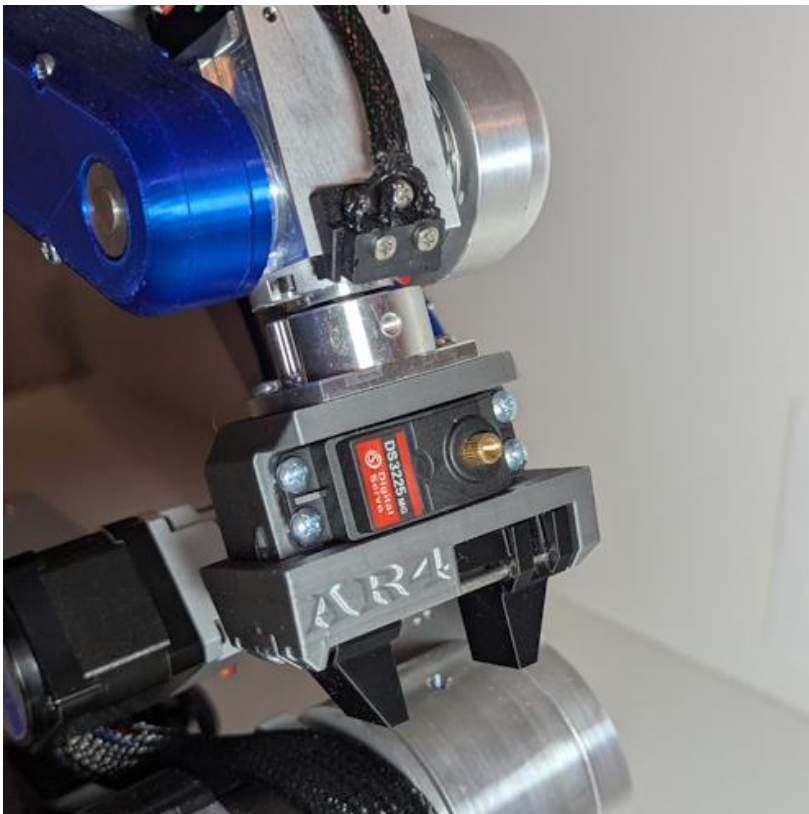

Install gripper on robot as shown in photo.

NOTE: do not install servo armature yet, this will be done in a future step.



Trim the servo wire.
Remove 8cm as shown.

This should leave 21cm
extending from servo
motor.

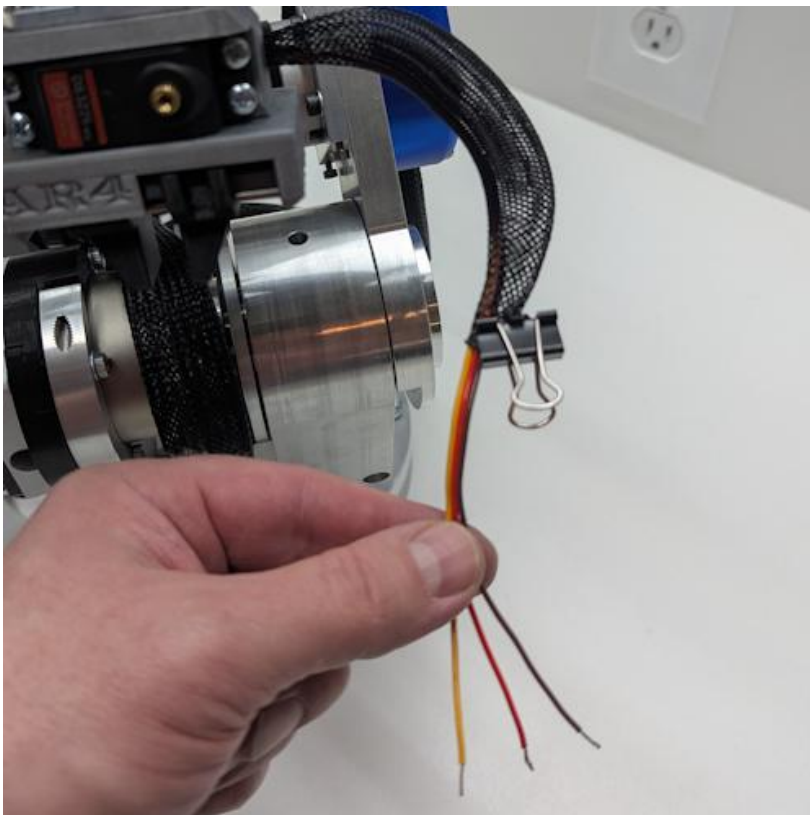

Cut 23cm length of $\frac{1}{4}$ "
braided sleeve, extend
servo motors through
sleeve – compress sleeve
as shown and use a clip to
hold it in place out of the
way.

Then strip wire ends as
shown in photo.



Solder and heat shrink the servo wires to the robot servo wires.

- Servo brown wire to robot black wire.
- Servo red wire to robot red wire.
- Servo yellow wire to green / white stripe wire

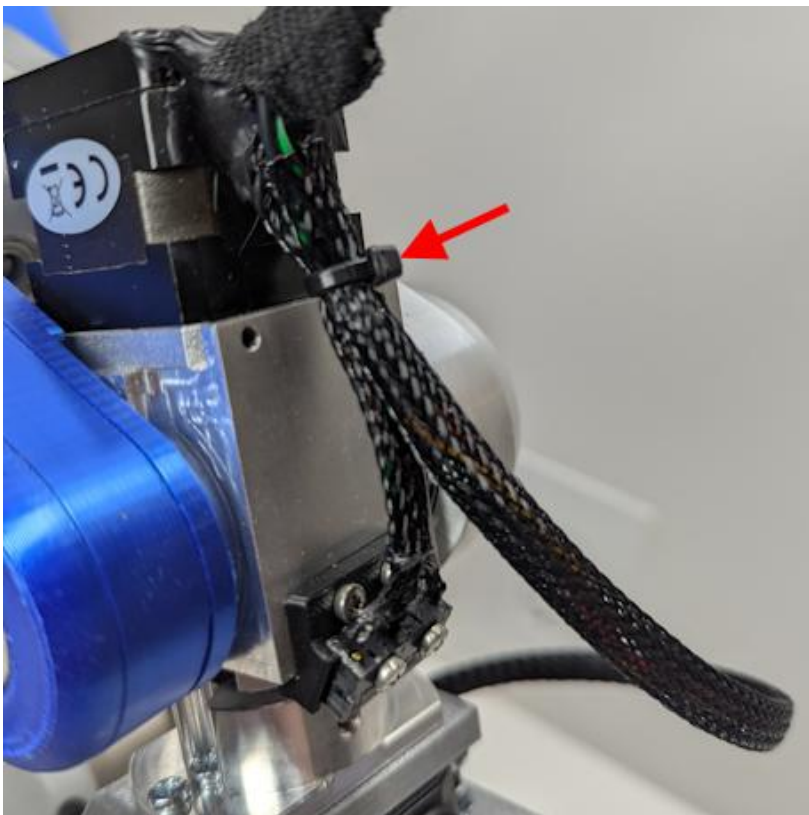

Remove clip holding back the braided sleeve, then extend the braided sleeve all the way up to the motor as shown.

Secure servo wires to J6 limit switch wires with a small cable tie (red arrow).



Apply liquid electrical tape around base of wire sleeve as shown.

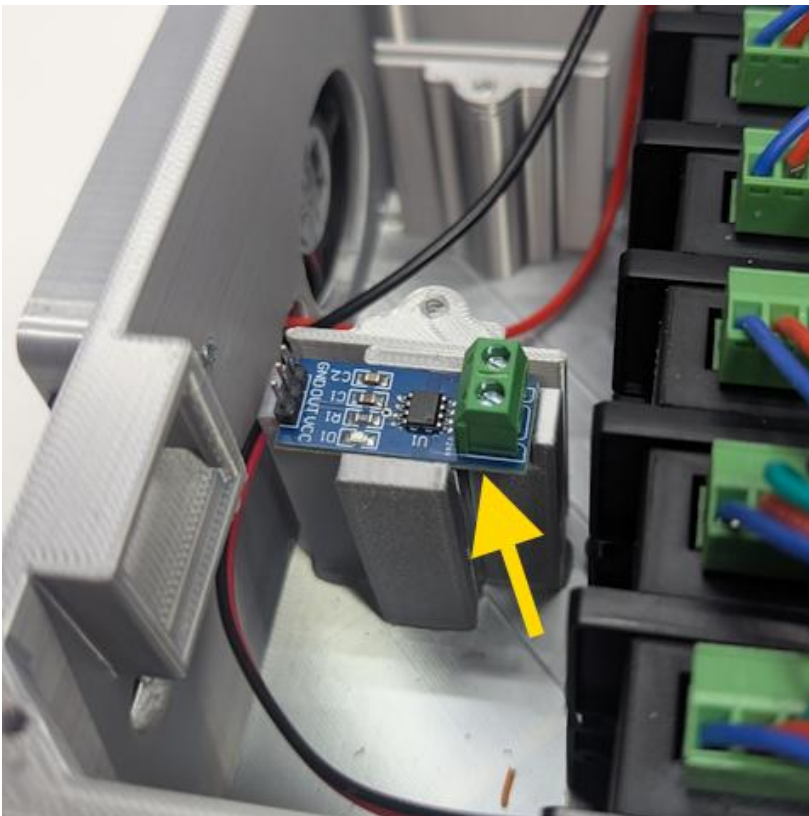

Open base enclosure and lift enclosure tray up.

Install ACS712 current sensor as shown. Sensor will snap into printed base enclosure.

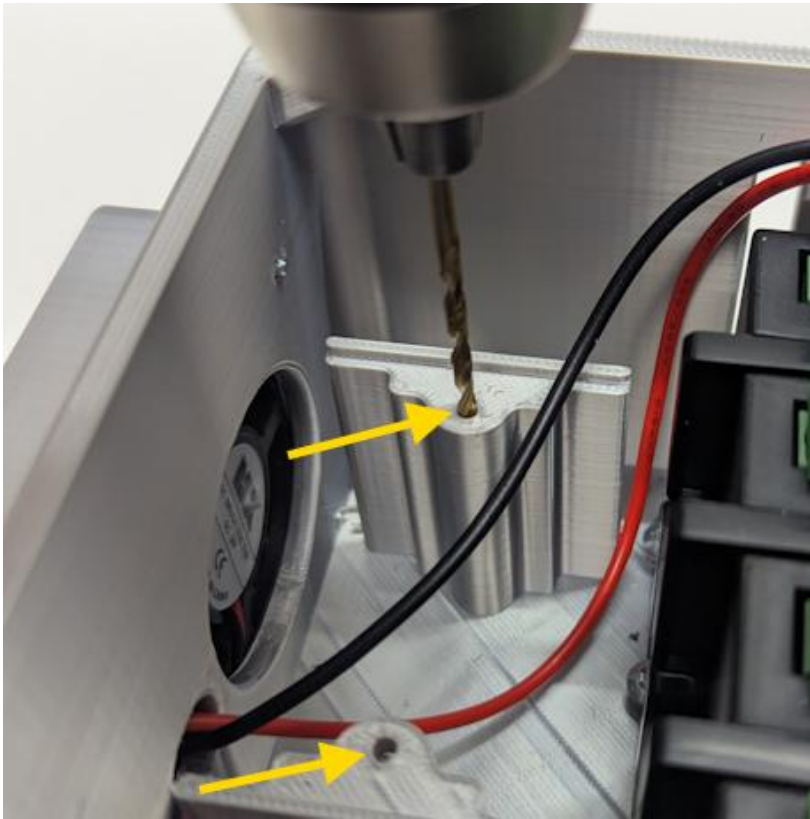

Use 2.5mm drill to clean out and size breakout board mounting holes as shown (yellow arrows)



Mount nano terminal board as shown using (2) #6 screws.

Make sure the TX1 and VIN pins are oriented to the left side of enclosure (top in picture) as indicated by the red arrows.

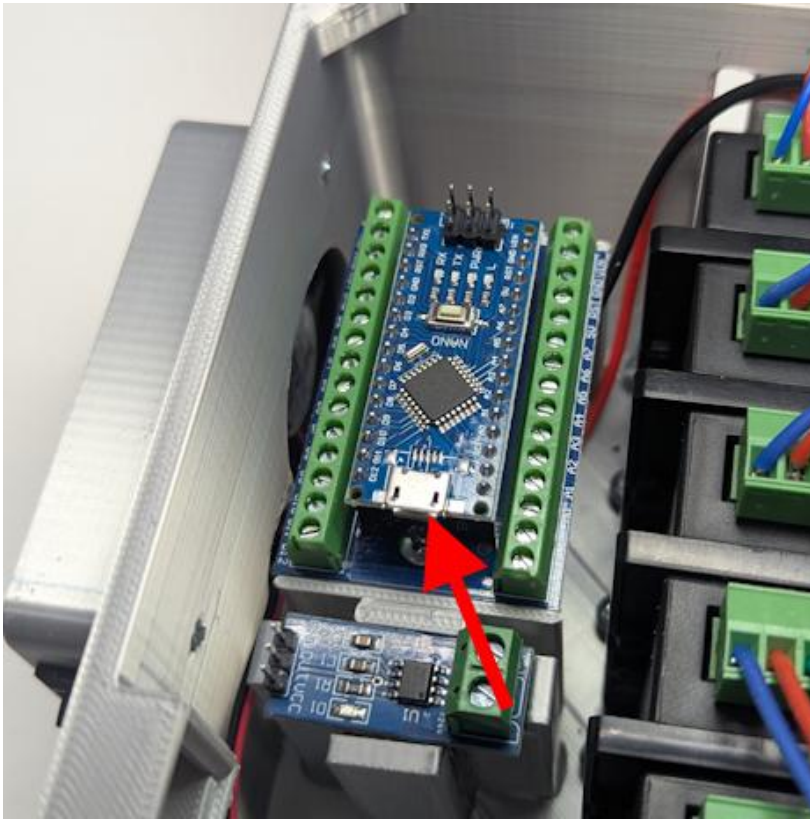

Insert nano board into terminal board as shown. Make sure the USB port is oriented to the right side of base enclosure (down in photo – red arrow).



Cut 20cm length of red and black 20awg wire.

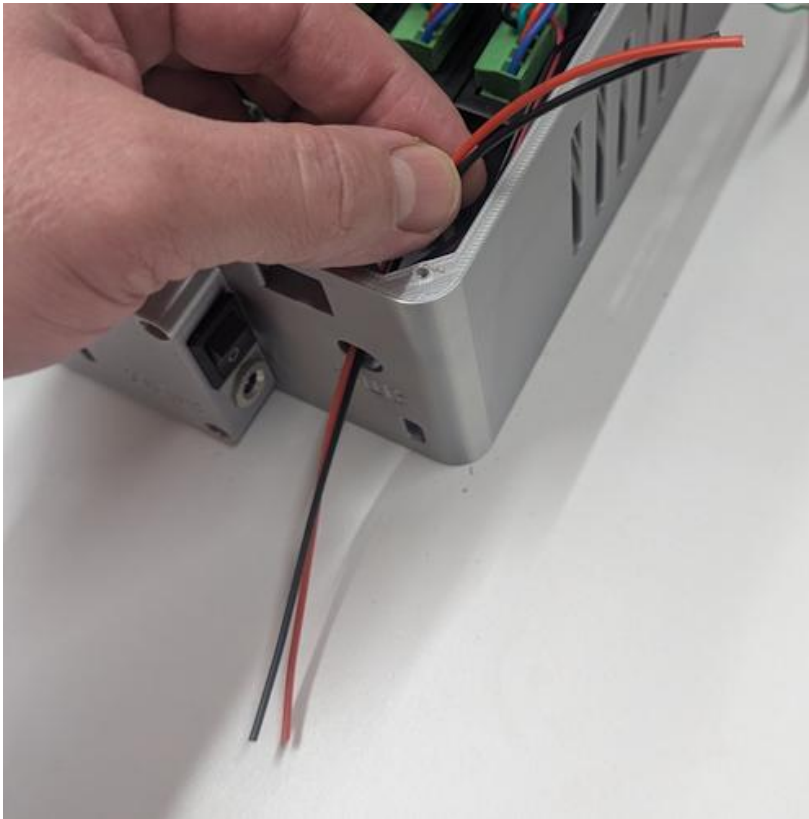

Insert Red and Black wires through rear power jack hole in base enclosure.

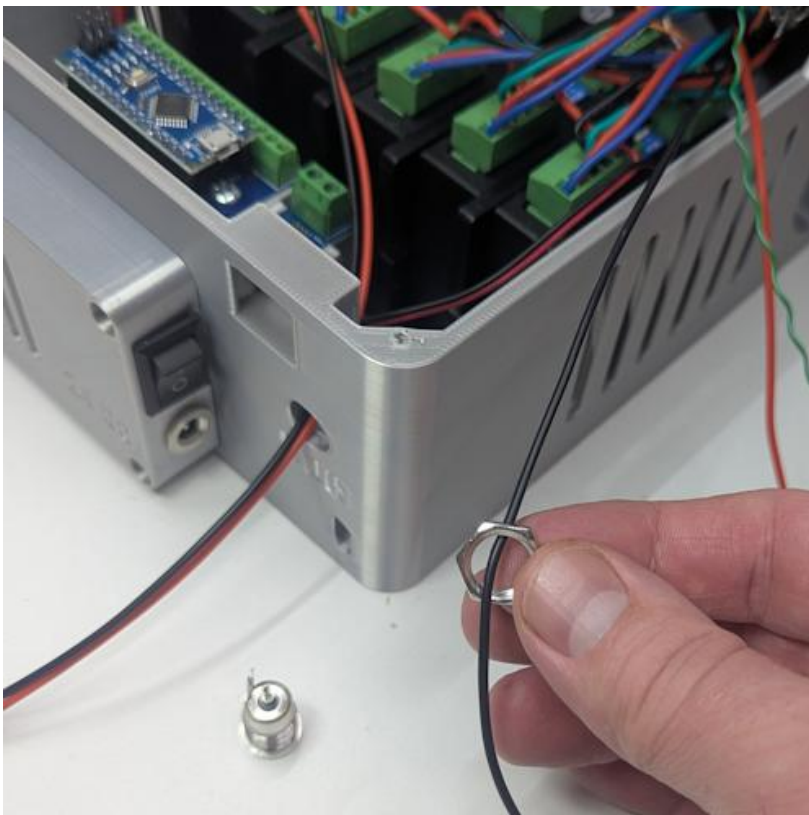

Feed the servo ground (black wire coming from right side gland nut) through the nut from 5.5mm DC power jack.

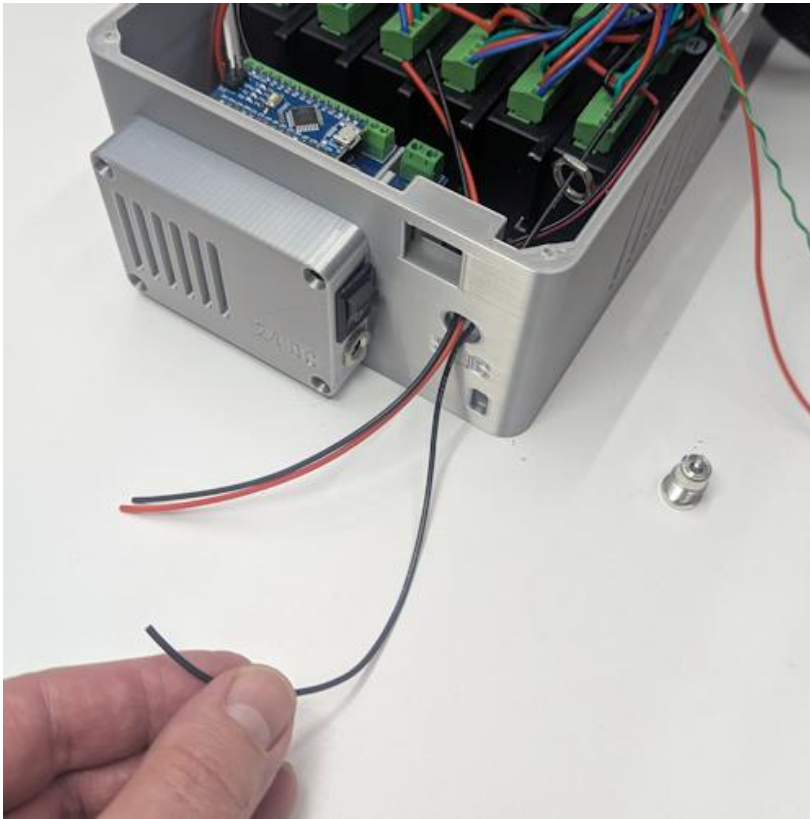

Feed the servo ground wire through the power jack hole in base enclosure along with the 20cm red and black wires

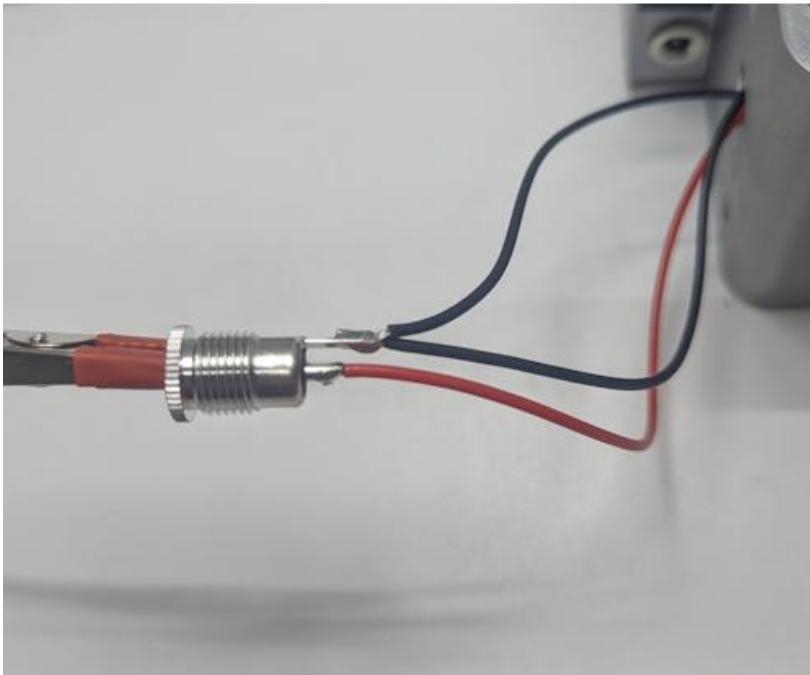

Solder both black wires to the 5.5mm DC jack GND body terminal.

Solder the red wire to the positive center terminal.



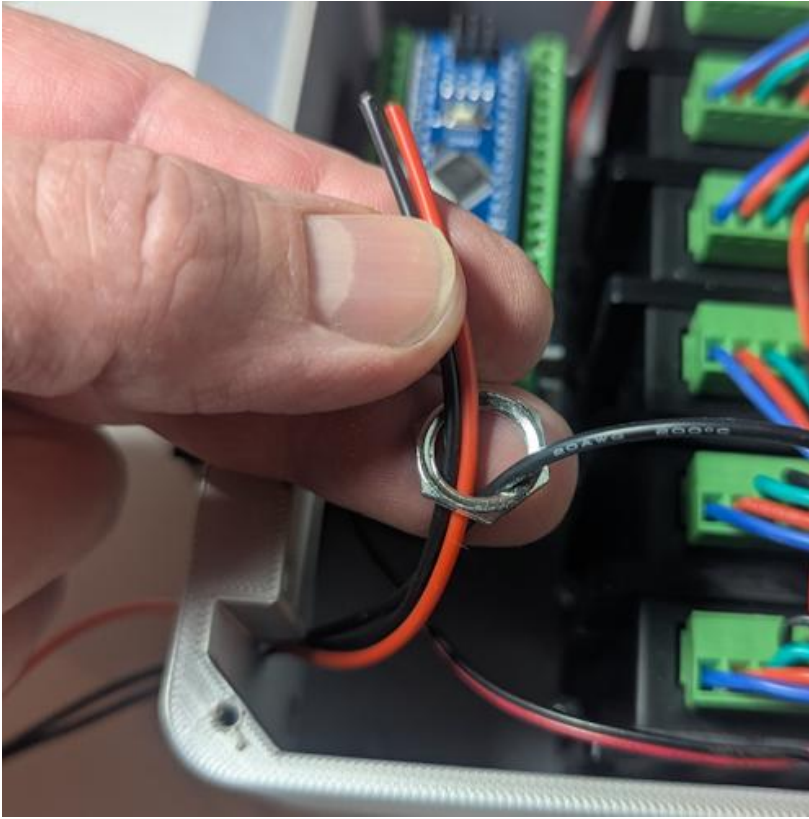

Feed the other end of the 20cm red and black wires through the DC jack nut as shown.

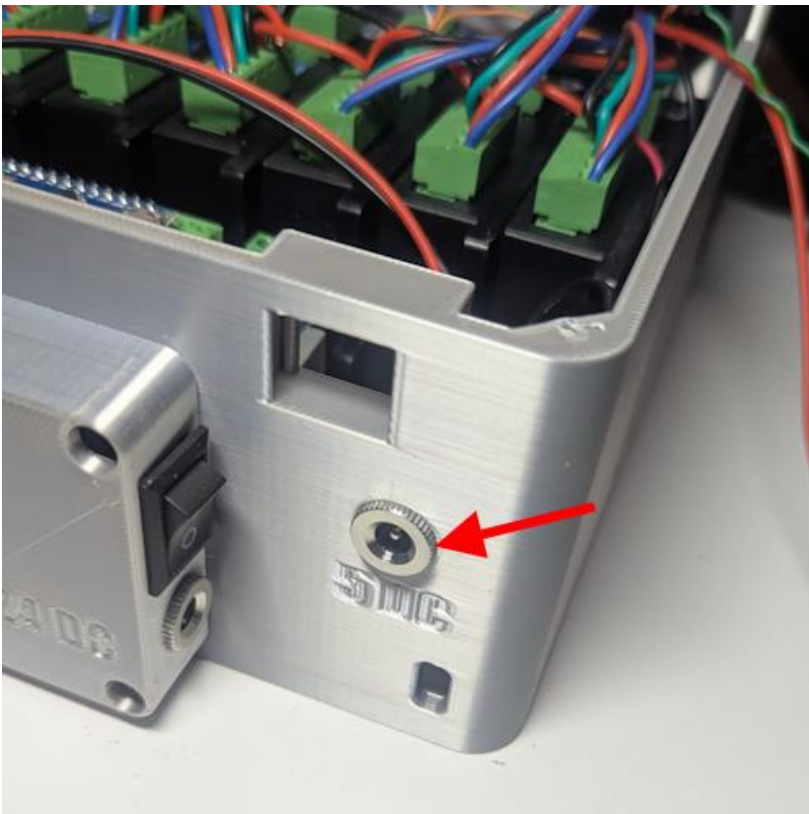

Install DC jack into base enclosure as shown and then tighten nut from back side.

The nut is difficult to access – tightening the nut using needle nose pliers or curved needle nose pliers is recommended.



Trim red wire from the DC jack to length as shown and connect to the left terminal on the ACS712 current sensor.

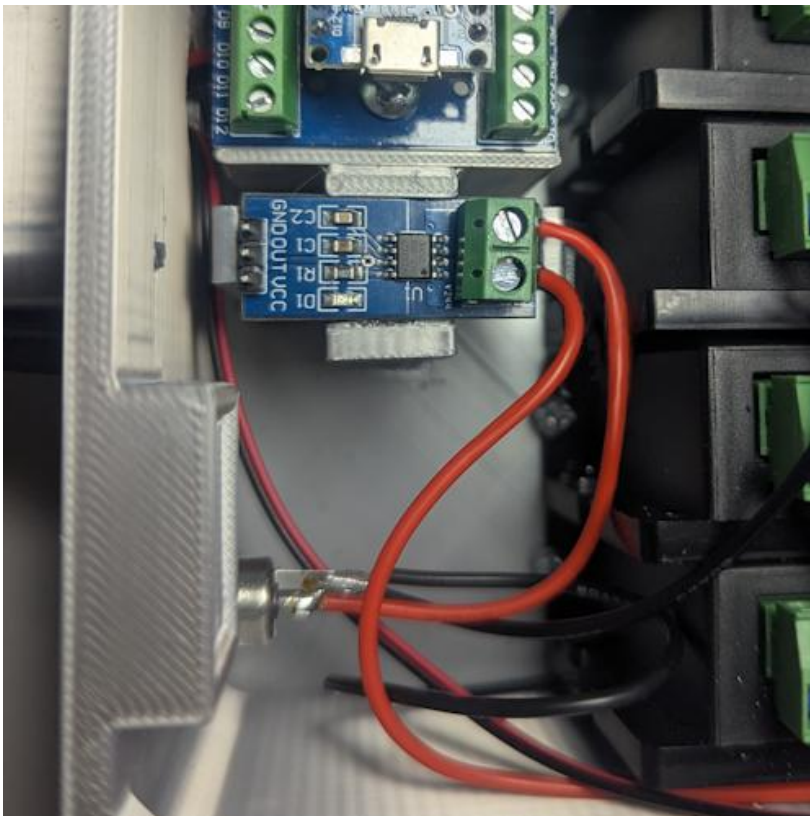

Trim red servo wire from the right gland nut to length as shown and connect to the right terminal on the ACS712 current sensor.

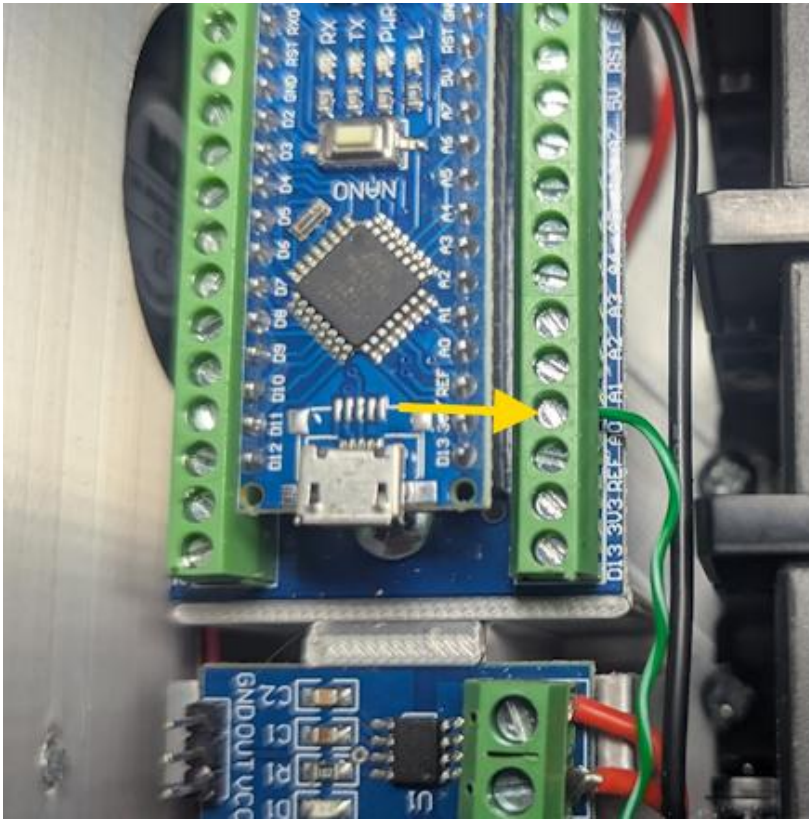

Trim green with white stripe servo signal wire from the right gland nut to length as shown and connect to the nano terminal "A0" on the nano breakout board as shown.

NOTE: it can be difficult to maneuver the wire into the screw terminal given the space available next to the drives. You can use mini needle nose pliers to position the wire, or if needed you can temporarily remove the nano and breakout board from the enclosure to assist in connecting the wires.

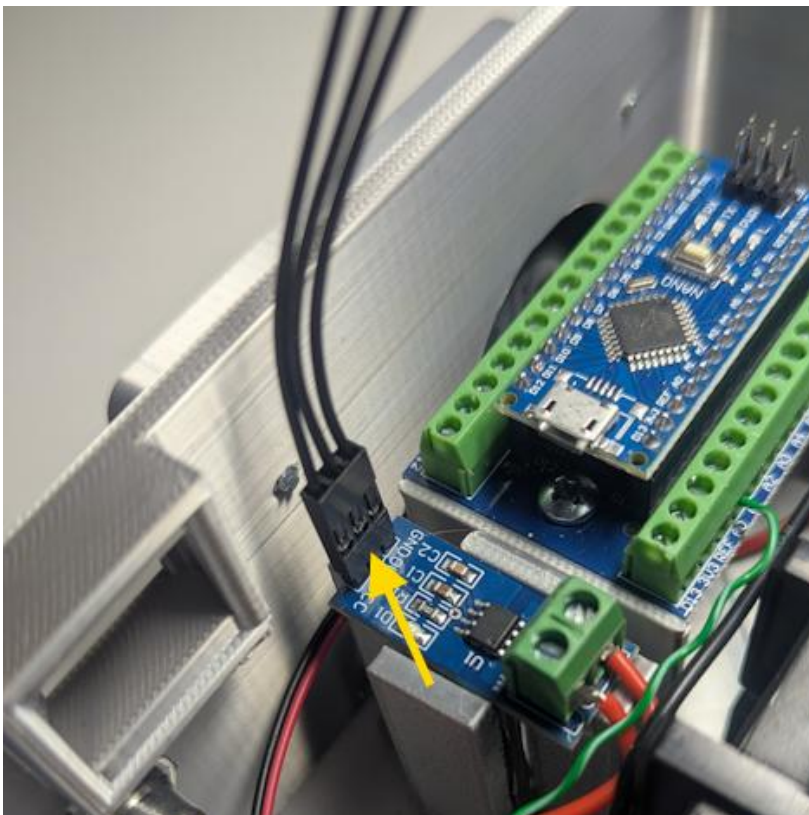

Plug Dupont 2.54 mm female 3 pin connector lead onto current sensor as shown.

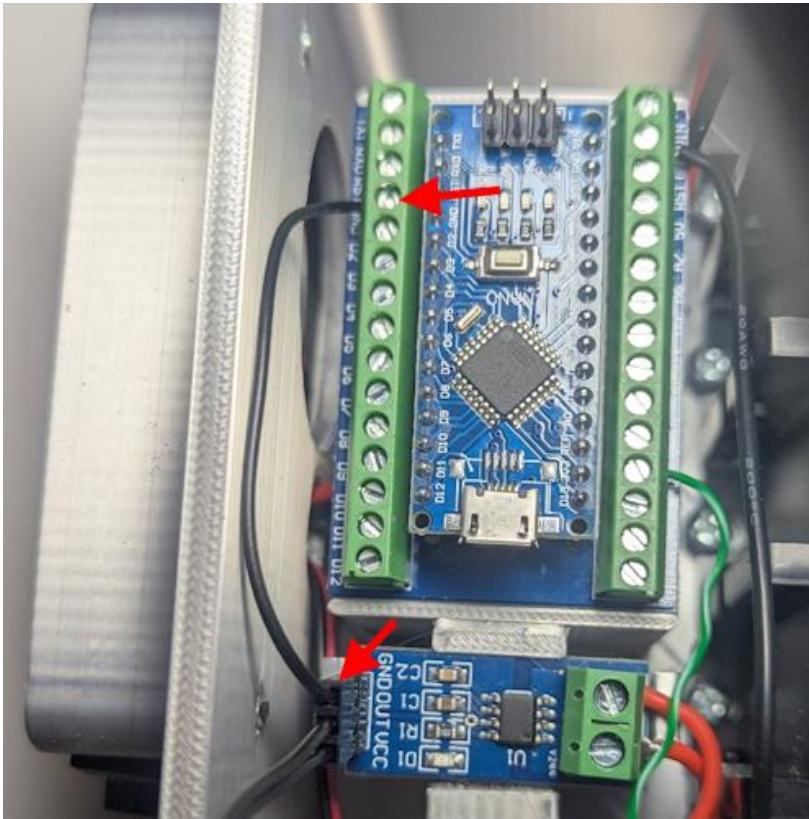

Connect the Dupont 2.54 GND (left) wire lead to the GND terminal on the nano breakout board.

NOTE: it can be difficult to maneuver the wire into the screw terminal given the space available next to the enclosure. You can use mini needle nose pliers to position the wire, or if needed you can temporarily remove the nano and breakout board from the enclosure to assist in connecting the wires.

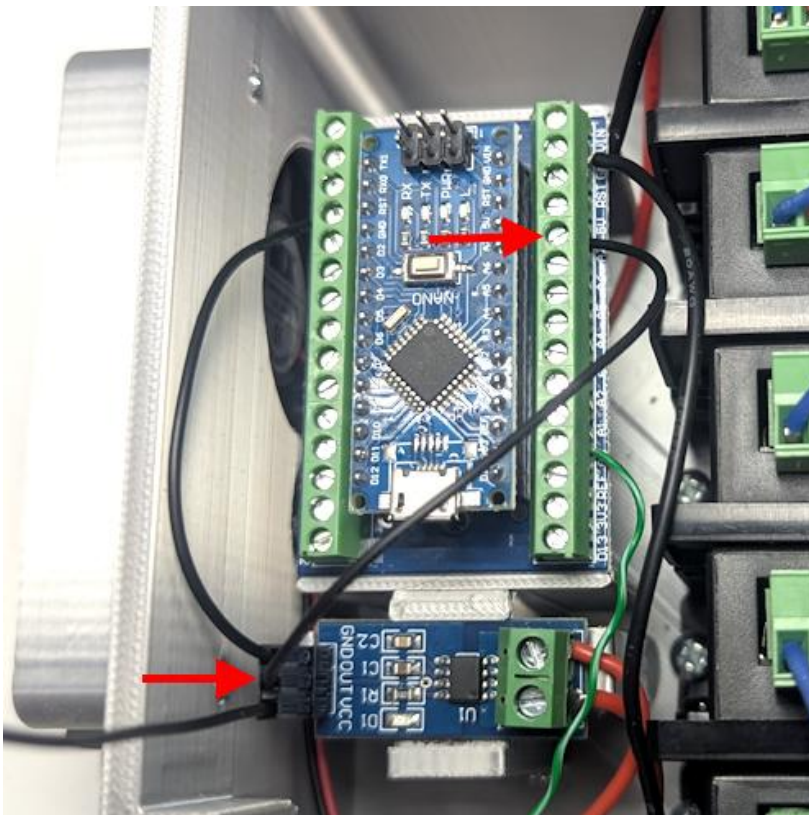

Connect the Dupont 2.54 OUT (center) wire lead to the "A7" terminal on the nano breakout board as shown.

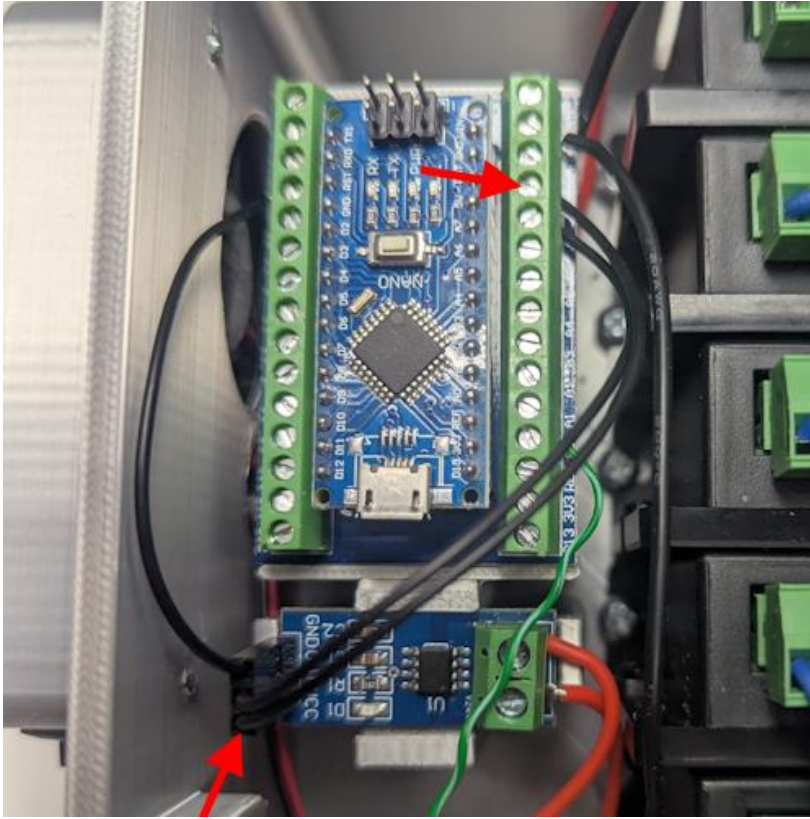

Connect the Dupont 2.54 VCC (right) wire lead to the "5V" terminal on the nano breakout board as shown.

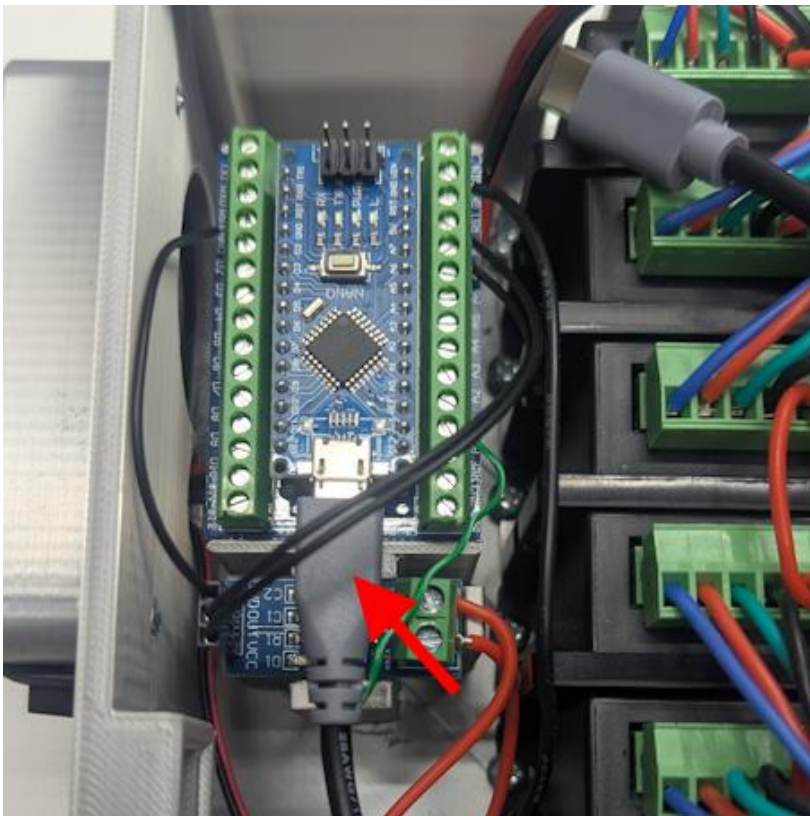

Plug micro end of USB cable into nano board as shown.

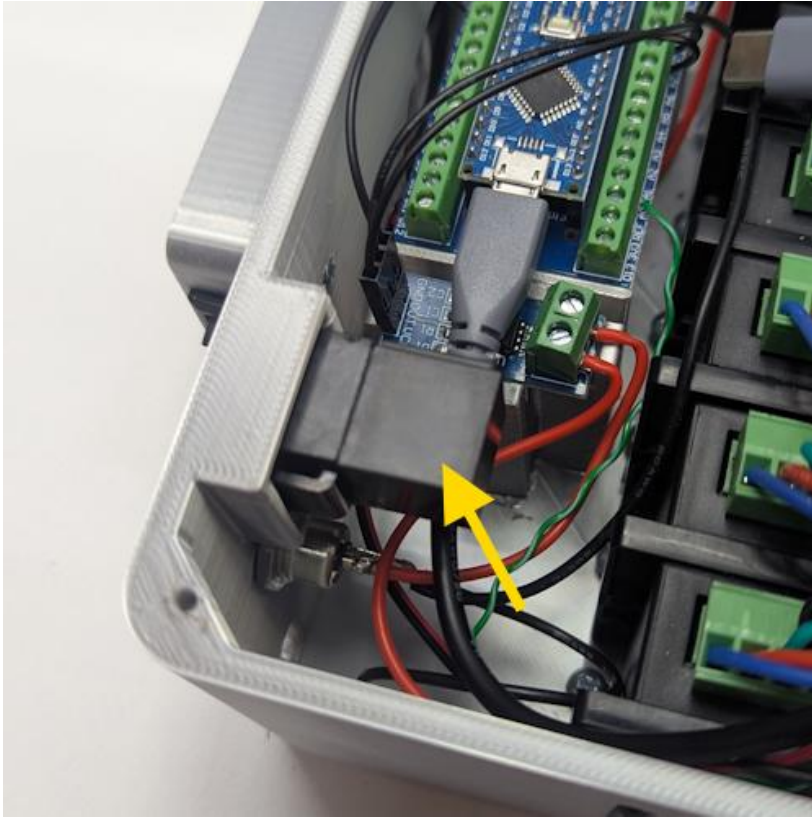

Insert USB 90° keystone jack in base enclosure as shown.

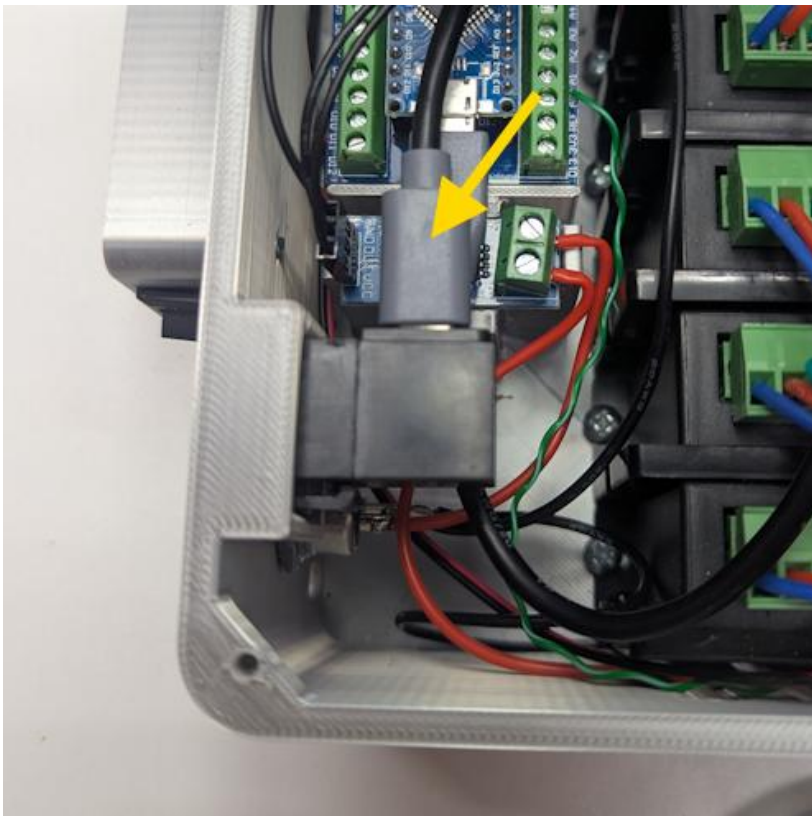

Plug "C" end of USB cable into keystone jack.

You can now lower enclosure tray and re-install lid.

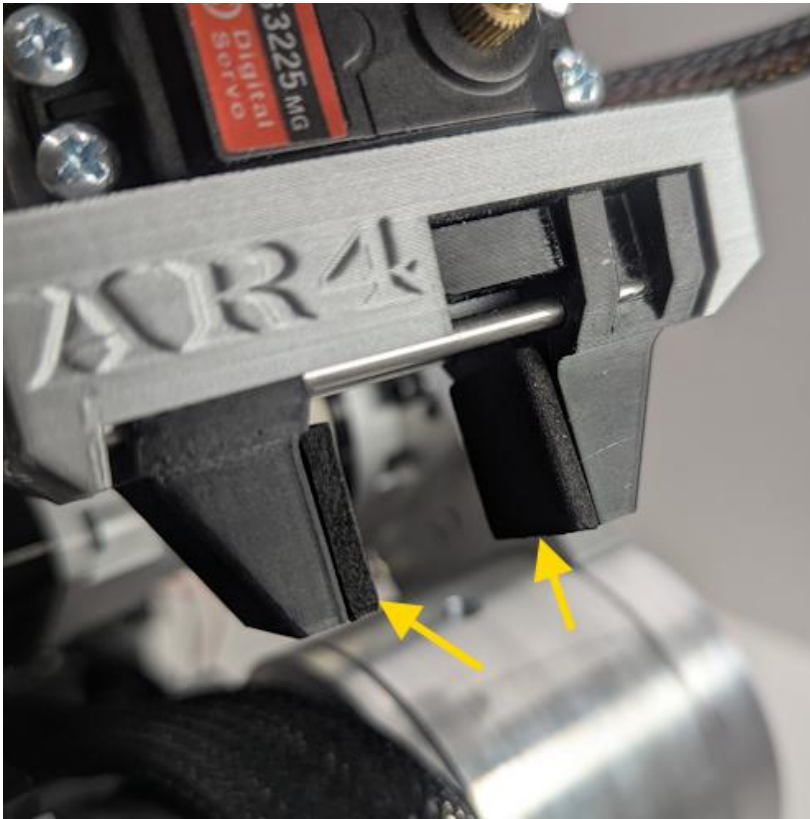

It is recommended to cut and apply self adhesive foam pads to the gripper jaws.



Plug 5vdc adapter and PC USB cable into auxiliary enclosure as shown.

Open the Arduino software, from the tools, AVR boards menu select the Arduino Nano.

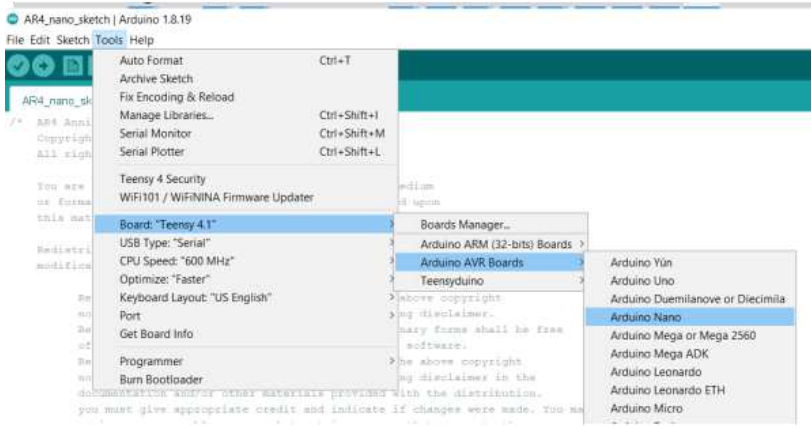

The standard ATmega328 option should work but if you find you have any issue uploading the sketch you can also try the old bootloader option.

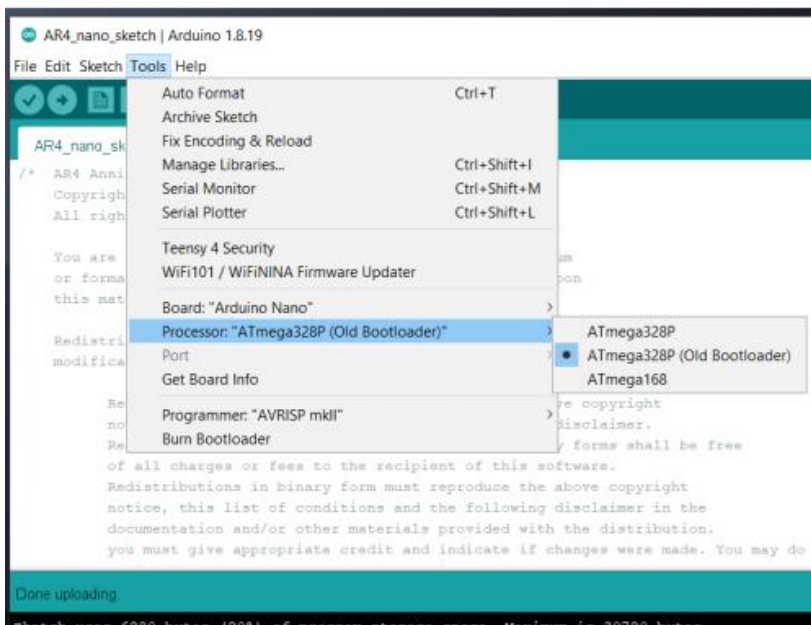

Device Manager

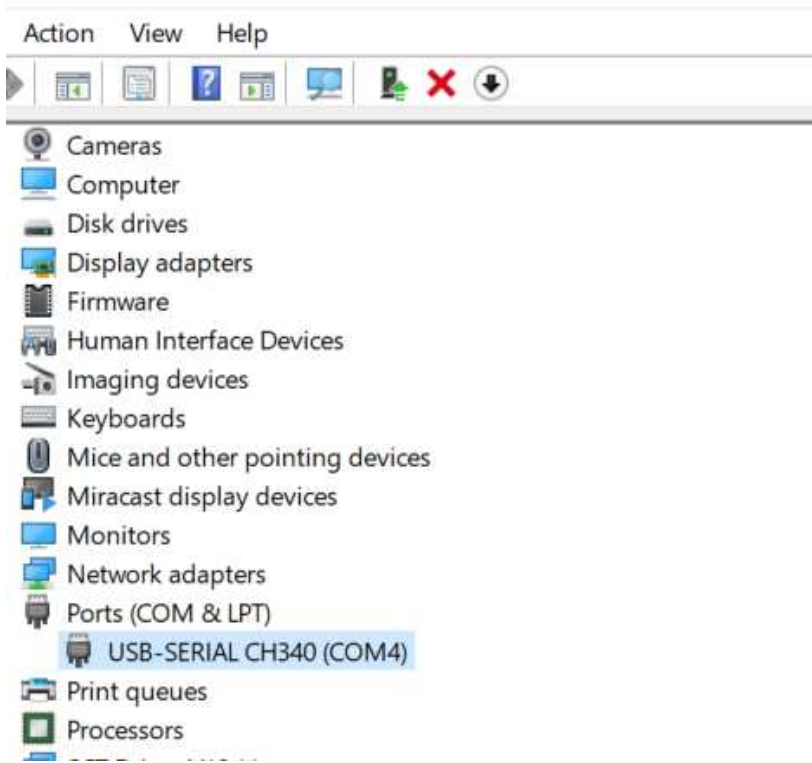

Open your device manager and double check which COM port your nano board connected to. In my case it's the only COM device plugged in at the moment so I know its COM4 but you can unplug and plug it back in and see which COM port updates on the list.

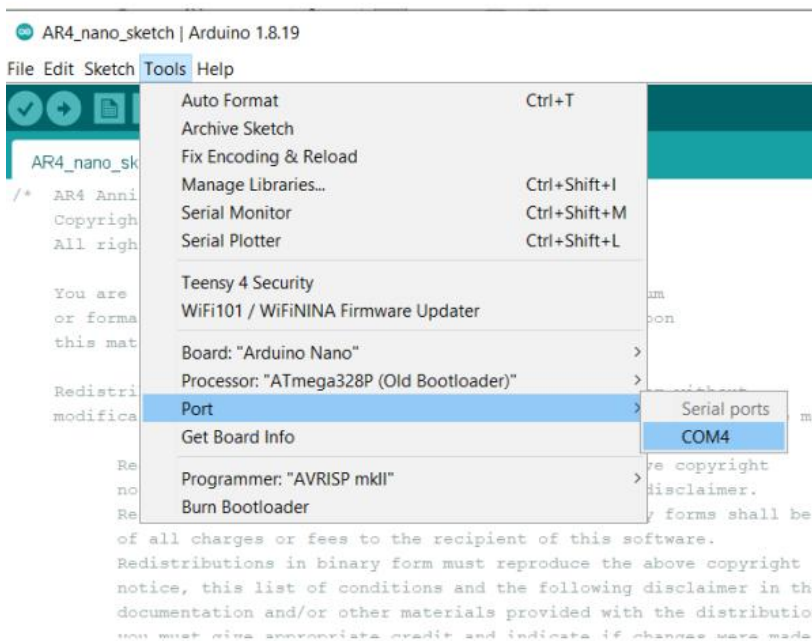

Double check from the tools, port menu that its set to the same COM as your device manager. In my case its COM4.

NOTE: In the AR4 software you will also want to set your Nano COM to this com port.

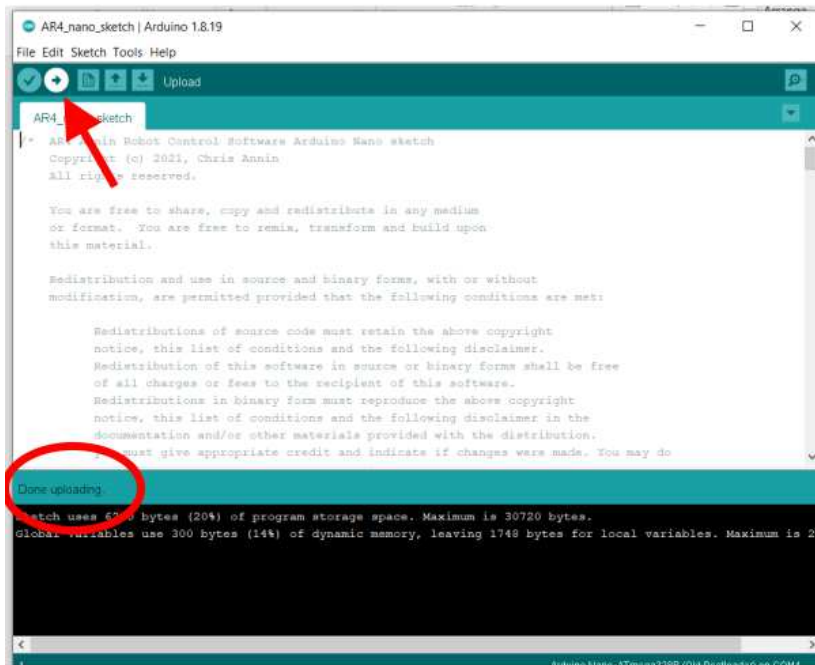

Press the upload sketch button to load the program to the Nano board. It should say done uploading when complete.

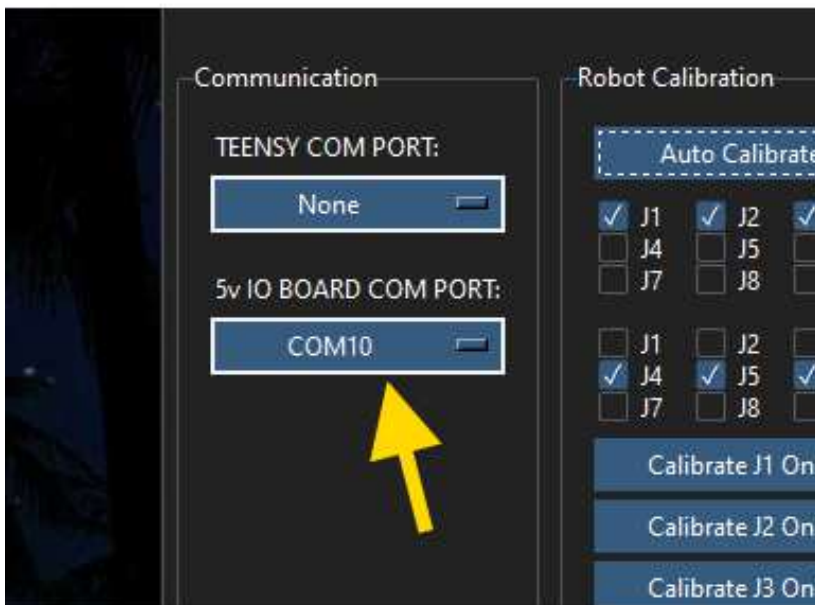

Open the AR4 software, from the config settings tab select the correct COM port for your IO board.

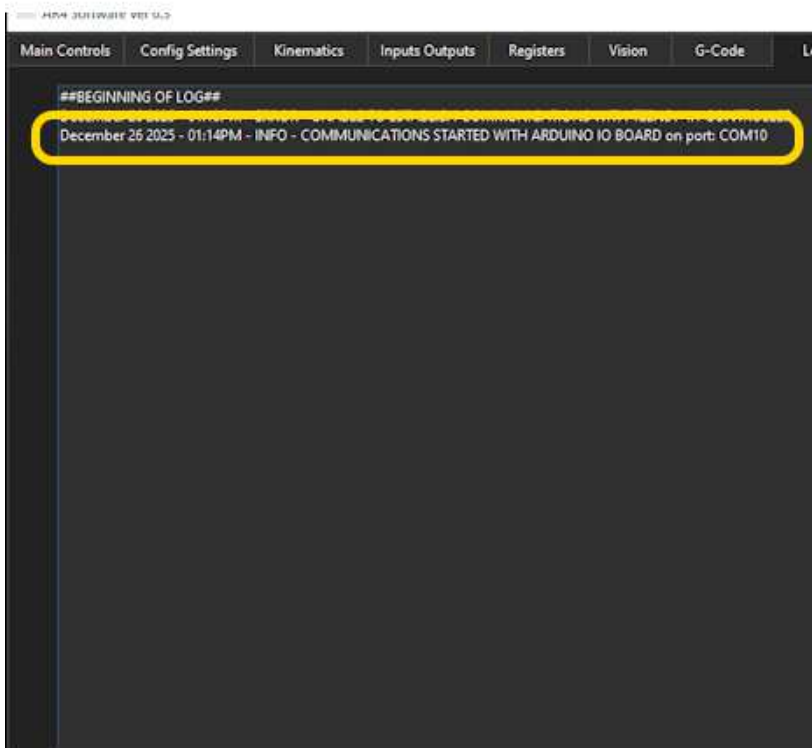

In the software log file it should say communications started with IO board.

AR4 Software Ver 6.3.1

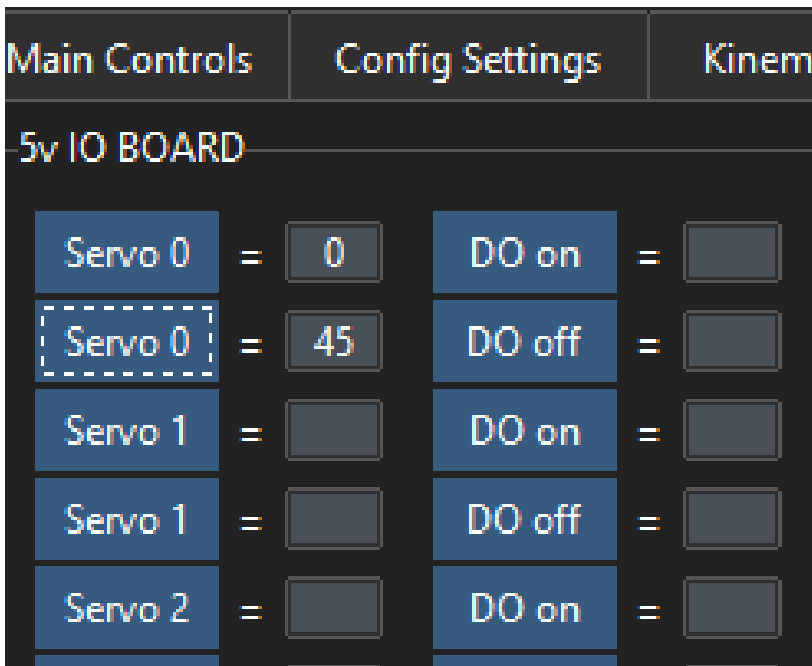

On the input output tab set the first Servo 0 field to "0" and set the second field to "45"

Press each Servo 0 button and you should hear and see the servo spindle rotate from its 0 position to the 45 degree position

In these instructions the gripper is wired to nano input A0 but if you want multiple servos you can use input A1 and that would be servo 1 in the AR4 software. NOTE: only servo 0 has overcurrent protection and is recommended for the gripper.

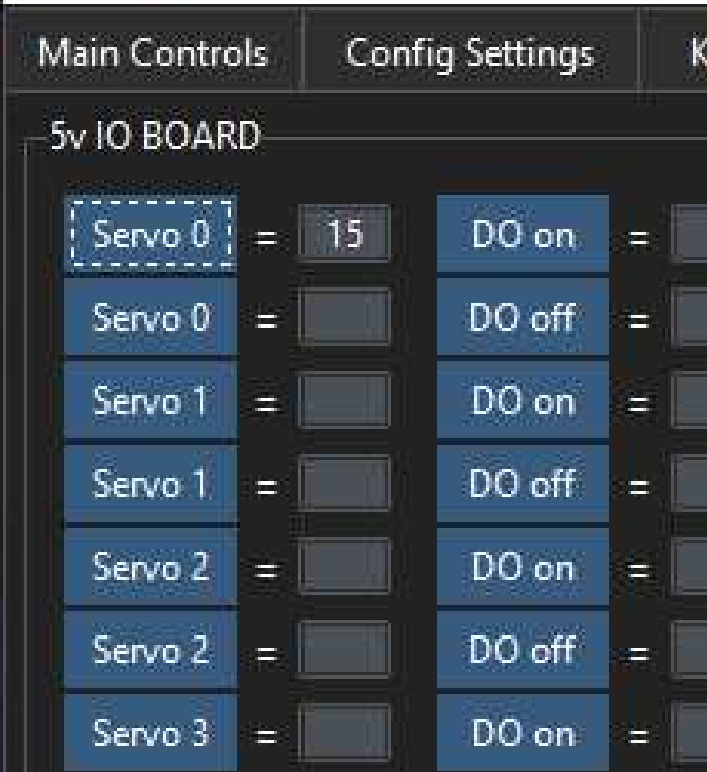

We need to install the servo gripper arm while the servo motor is in the correct position.

So that the gripper is applying adequate pressure in the fully closed position set the servo to a value of 15.



Install M3x5 socket head cap screw in servo armature.



Close the gripper jaws by hand and then install the servo armature as shown while the servo is set to 15.

Be sure to tighten arm clamp screw on side and front retention screw.

Now you should be able to press the servo button at 0 and 45 to fully open and close the gripper.

NOTE: the servo is capable of rotating from 0 to 180 but this gripper only needs 45 degrees to fully open.

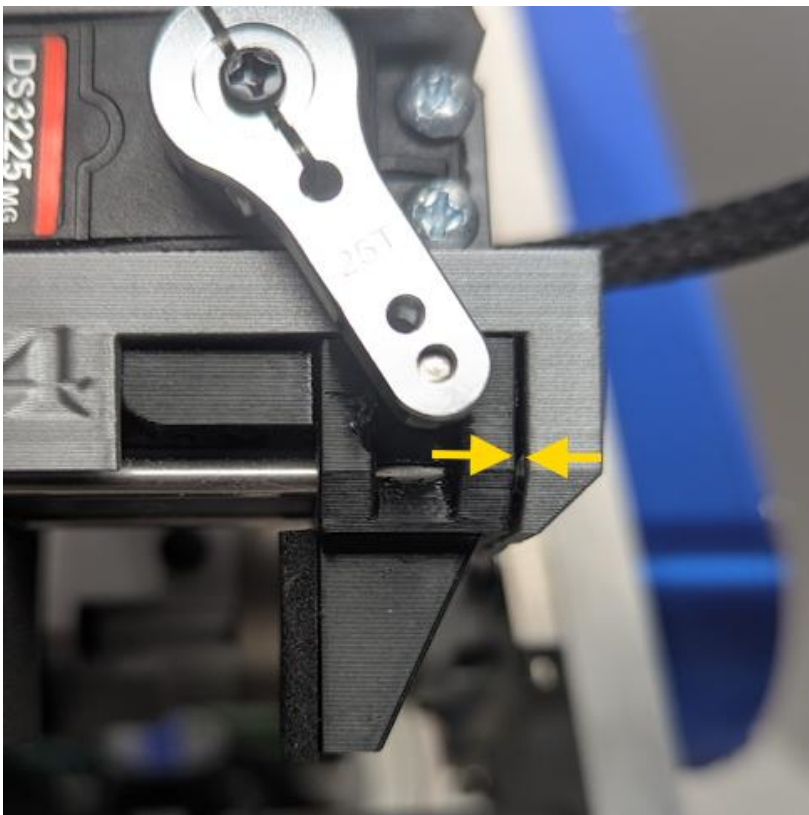

Set the gripper to the 45 open position and verify there is a small gap as shown – the servo should be relaxed and not applying pressure in the open position.

If there is no gap and the servo is trying to force the jaws in the open position or is pushing on the jaw in the open position then either re-check the last step, or lower the open position setting to a smaller value.

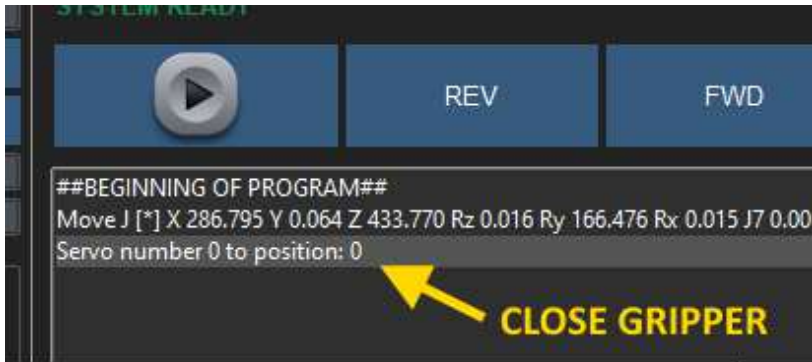

To open and close the gripper from a program use the servo device command button to add the program commands shown:

Servo 0 to position 0 to close the gripper.

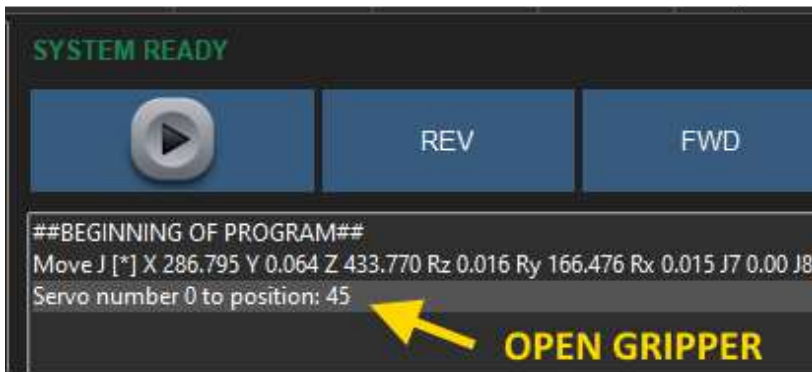

Servo 0 to position 45 to close the gripper.

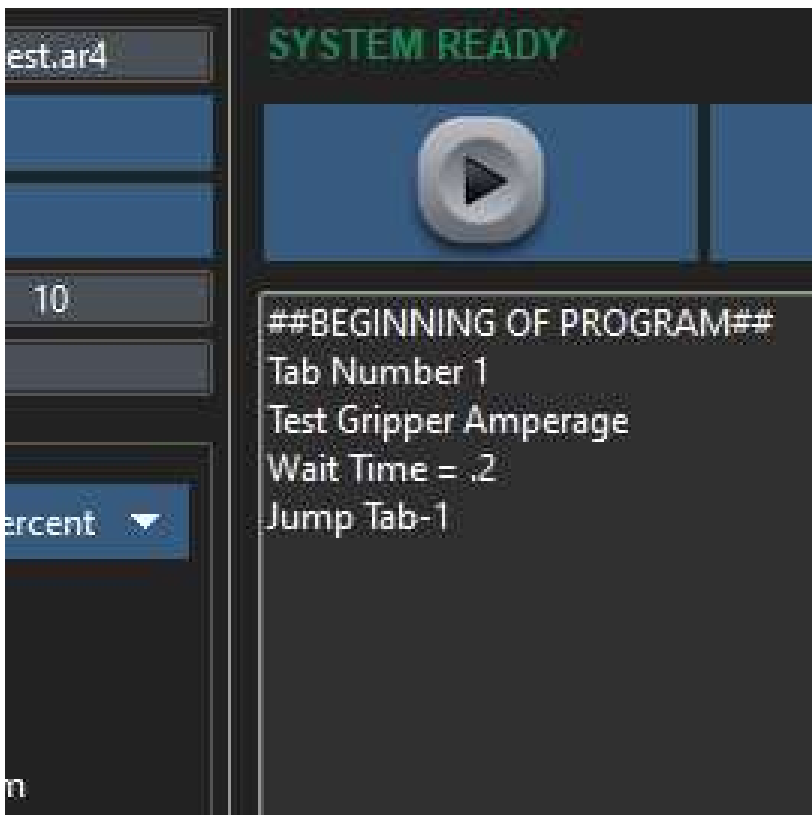

The ACS712 amperage sensor provides additional overcurrent protection.

If the current is higher than .8 amps the nano sketch will slowly back off the gripper position in small increments until the amperage is in an acceptable range.

If you would like you can create the program shown – type “Test Gripper Amperage” into the manual program entry field to create this command. When you press play your gripper current will be displayed in the manual program entry field.

REFERENCE:

This is a high level wiring diagram to help visualize the servo wiring.

The servo should be wired as shown. Note the power supply -5v is shared with the Arduino -5v or GND terminal.

Please see this video for more information on servo wiring.

<https://youtu.be/76F6dS4ar8Y>

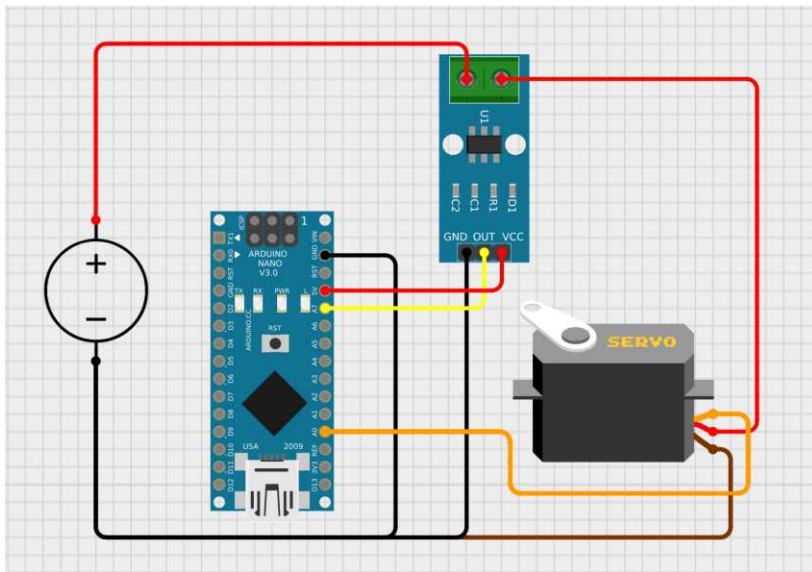

REFERENCE:

The Nano sketch file for the AR4 robot allocates the servo and input / outputs indicated in red text in the diagram shown.

Using the Nano you can control up to 8 servos, 8 digital outputs and monitor up to 8 inputs.

Note the Arduino Mega board can also be used if additional IO is required for your project.

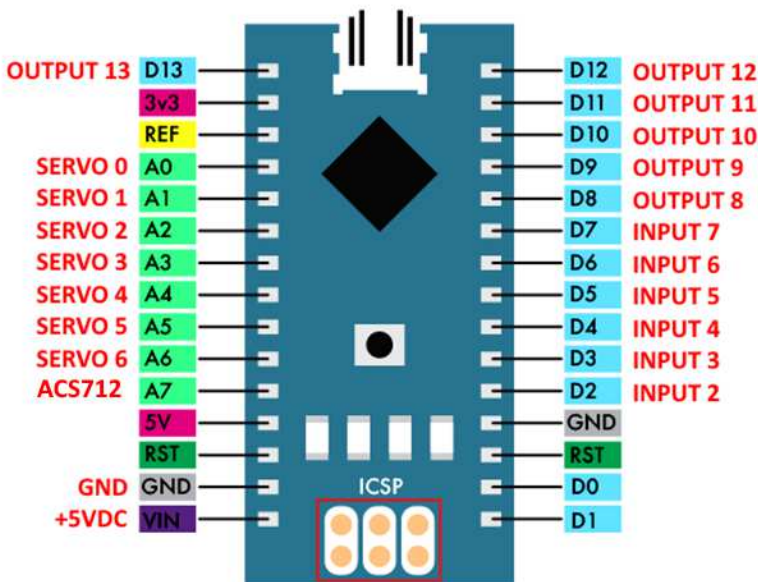

CHAPTER 6

ADDITIONAL AXIS

The AR4 robot has the capability of controlling up to 3 additional axis (7th, 8th and 9th axis). The most common additional axis is a 7th axis travel track which will be covered in the chapter. Other uses for an additional axis are applications such as having the robot control the focus and aperture on a camera, having the robot control a turn table or part rotation device or having the robot control a stepper motor controlled gripper.

This chapter will illustrate the installation of drivers and wiring for a 7th and 8th axis. An additional drive for a 9th axis can be installed following the same directions but is not shown. Additionally this chapter shows the construction of the a 7th axis travel track using 500mm length guides but you can build the track any length you want. Track can be screw drive as shown or you can design your own track or use a belt drive if desired.

Any stepper motor can be used that meets the amperage requirements of the DM332 or DM320T drivers shown



Additional Axis Bill of Materials

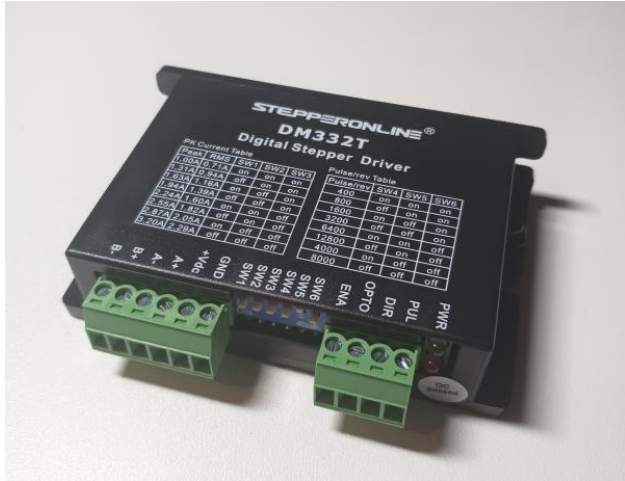

DM332T digital stepper driver.

You will need one drive for each axis you would like to add, you can also use the DM320T if you are driving a smaller motor.

Drivers are available factory direct from Stepperonline.

18awg 4 conductor cable (200cm long)

Cable can be any length depending on how far you want to mount enclosure from motors.



CAT6 RJ45 Keystone jack
Qty(2)



KCD1 SPST rocker switch with lead wires.



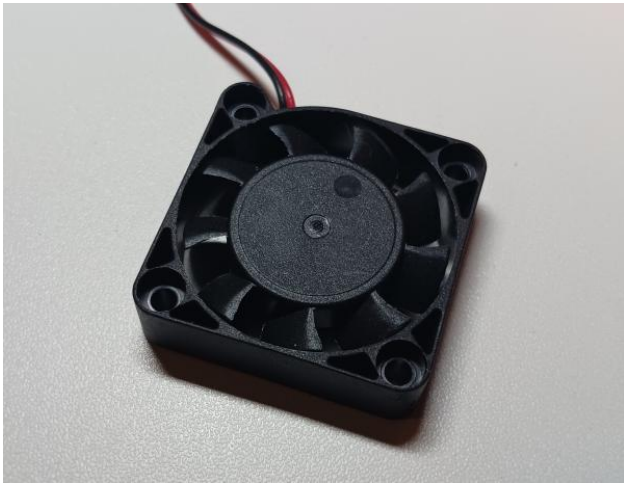

40mm 24vdc brushless cooling fan.



5.5mm DC power jack socket.



30cm length of CAT5 cable





Auxiliary enclosure

-

The 3D print file for this part can be found along with the robot print files on the downloads page.



Auxiliary enclosure lid

-

The 3D print file for this part can be found along with the robot print files on the downloads page.



J1 Base enclosure fan cover

-

This is the same 3D printed part that is used on the robot base.



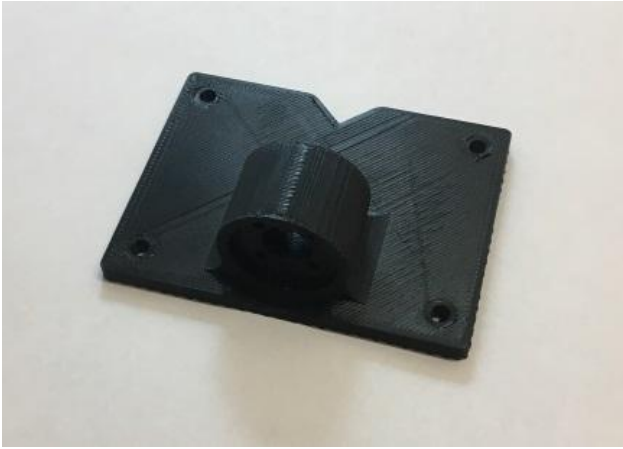

DRIVE MOUNT (x1)



BEARING SPACERS

You will need 2 spacers:

- (1) 13mm spacer
- (1) 15mm spacer

(They look identical except for the height)

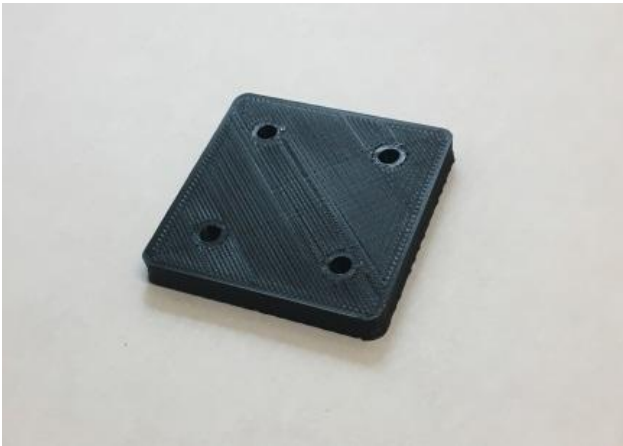

BLOCK SPACER (x4)

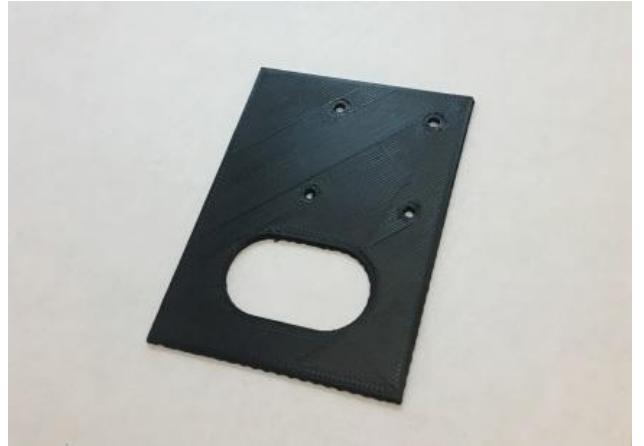

TEMPLATE (x1)





Nema 17 Bipolar 59Ncm (84oz.in) 2A 42x48mm 4 Wires w/ 1m Cable & Connector

★★★★★ 19 reviews | Write a review

SKU: 17HS19-2004S1

\$11.14 ~~\$14.71~~

Bulk quantity price break:

Qty	3	10	30	100
Price	\$10.70	\$9.81	\$9.36	\$8.47
Save	27%	33%	36%	42%

Availability: 8126

* Ship from

[China](#) [United States](#) [Germany](#) [United Kingdom](#) [Australia](#) [Russian Federation](#)

- 1 + [ADD TO CART](#) [♡](#)

[Report error](#) / [Notify inventory](#) / [Request bulk price](#)

NEMA 17 stepper motor

SKU: 17HS19-2004S1



Nema 17 Bracket for Stepper Motor and Geared Stepper Motor Alloy Steel Bracket

★★★★★ 8 reviews | Write a review

SKU: ST-M1

\$2.44

Bulk quantity price break:

Qty	3	10	30	100
Price	\$2.28	\$2.12	\$1.96	\$1.79
Save	6.67%	13.33%	20%	26.67%

Availability: 471

* Ship from

[China](#) [United States](#) [Germany](#) [United Kingdom](#) [Australia](#) [Russian Federation](#)

- 1 + [ADD TO CART](#) [♡](#)

[Report error](#) / [Notify inventory](#) / [Request bulk price](#)

[Like](#) [Twitter](#) [Pinterest](#) [Share](#)

NEMA 17 bracket

SKU: ST-M1



SFU1204 12mm 500mm End Machine Ball Screw Single Flange BallNut US Stock



Price: **\$22.80** & **FREE Shipping**

New (1) from **\$22.80** + FREE Shipping

Specifications for this item

Part Number	1SBA1733140VQ0G409
UPC	190459164566
Brand Name	CHUANGNENG

Qty.(1) SFU1204 Ball Screw. In this build we are using 500mm long screw and guides but you can use any length you like. This item is typically available from Amazon, AliExpress or other online bearing suppliers – There are a number of brands out there but any SFU1204 will work.

CNC Linear Guide Way Rail Kit Set --- 2pcs Fully Support SBR 12-500mm 12mm Ball Bearing Linear Slide Rail Shaft + 4pcs SBR12UU Blockbearing

[Be the first to review this item](#)

Price: **\$61.29** & **FREE Shipping**

Note: Not eligible for Amazon Prime.

In Stock.

Get it as soon as March 28 - April 18 when you choose **Standard Shipping** at checkout.

Ships from and sold by [nineone](#).

- Metal linear bearing rail and blocks with pre-drilled holes for ease of mounting
- Durable construction for long-lasting performance
- Can be used in automatic industry machines such as robot, calculator, automatic recorder, accurate printer, etc.
- This set included 2pcs SBR12-500mm Linear Bearing Rail and 4pcs SBR12UU Block Bearing.
- This linear bearing is durable and sturdy, which can prolong the transmission life span of your machines.



Qty.(1) SBR-12 12mm linear slide with bearings. In this build we are using 500mm long screw and guides but you can use any length you like. This item is typically available from Amazon, AliExpress or other online bearing suppliers.



PGN - KP08 Pillow Block Ball Bearing - 8mm Bore - P08 Base (2 Pack)



Price: \$6.45 ✓prime

New (1) from \$6.45 ✓prime FREE Shipping

Specifications for this item

Part Number	PB-KP08/2
UPC	760655001042
Measurement System	Metric
Specification Met	Iso 9001 , Aisi 52100
Bore Diameter	8.00 millimeters

Qty.(1) KP08 – 8mm bore pillow block bearing. These are typically sold in pairs of 2 so you will have 1 extra. This item is typically available from Amazon, AliExpress or other online bearing suppliers.

PGN - KP000 Pillow Block Ball Bearing - 10mm Bore - P000 Base (2 Pack)



★★★★★ 1 rating

Price: \$7.45 ✓prime

New (1) from \$7.45 ✓prime FREE Shipping

Specifications for this item

Part Number	PB-KP000/2
UPC	760655001028
Measurement System	Metric
Specification Met	Iso 9001 , Aisi 52100
Bore Diameter	10.00 millimeters

Qty.(1) KP000 – 10mm bore pillow block bearing. These are typically sold in pairs of 2 so you will have 1 extra. This item is typically available from Amazon, AliExpress or other online bearing suppliers.



4 Pin Metal Male Female Panel Connector 10 GX16-4 Silver Aviation Plug of 10 pcs

★★★★☆ 1 customer review

Note: This item is only available from third-party sellers (see all offers)

Available from these sellers.

- Product Name : Aviation Connector Plug;Model : 16-4;Type : Male Female
 - Contacts Pin Number : 4
 - Rated : 125V/5A;WorkingVoltage : AC 200V;Withstand Voltage : AC
 - Total Size : 4.7 x 1.9cm/ 1.8" x 0.7" (Lx Max.W);
 - Material&Package: Metal;10 Pairs Aviation Connector Plug
- › See more product details

Compare with similar items

New (1) from \$12.99 + \$5.27 shipping

GX-16 aviation plug (x2)

6061 Aluminum Sheets, Bars, and Cubes



Bars

Wd.	Temperature Range, °F		1 ft. Lg.
1/4" Thick. (-0.012" to 0.012" Tolerance)			
6"	-320° to 300°	8975K437	\$13.37

6061 Aluminum, 1/4" Thick x 6" Wide, 1 Foot Long

Each

ADD TO ORDER

In stock

12" x 6" x 1/4" aluminum plate (x1)- McMaster Carr

Additional Axis Assembly

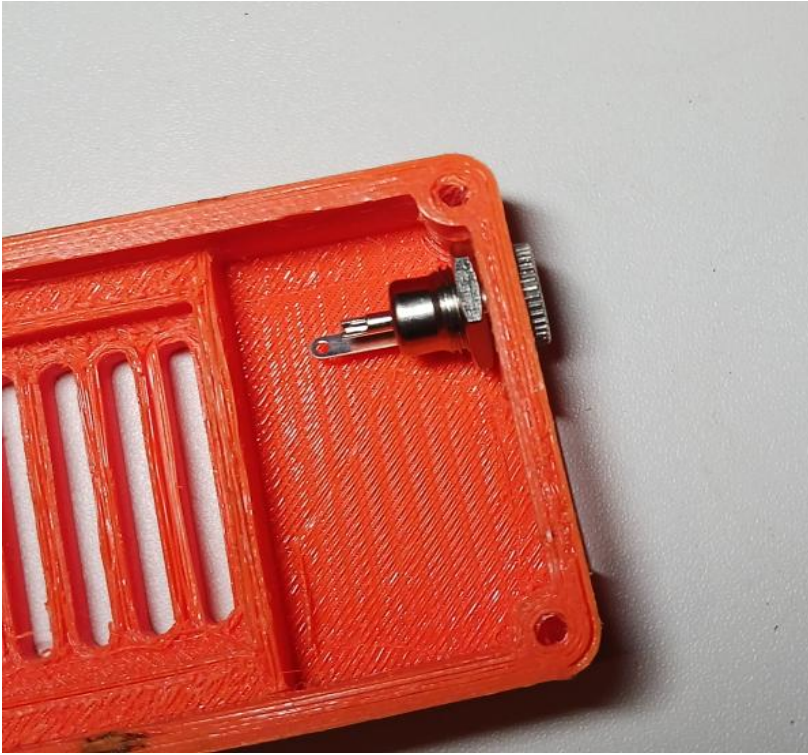

Remove all build structure from 3D printed Base Enclosure Fan Cover then install the 5.5mm power jack as shown.

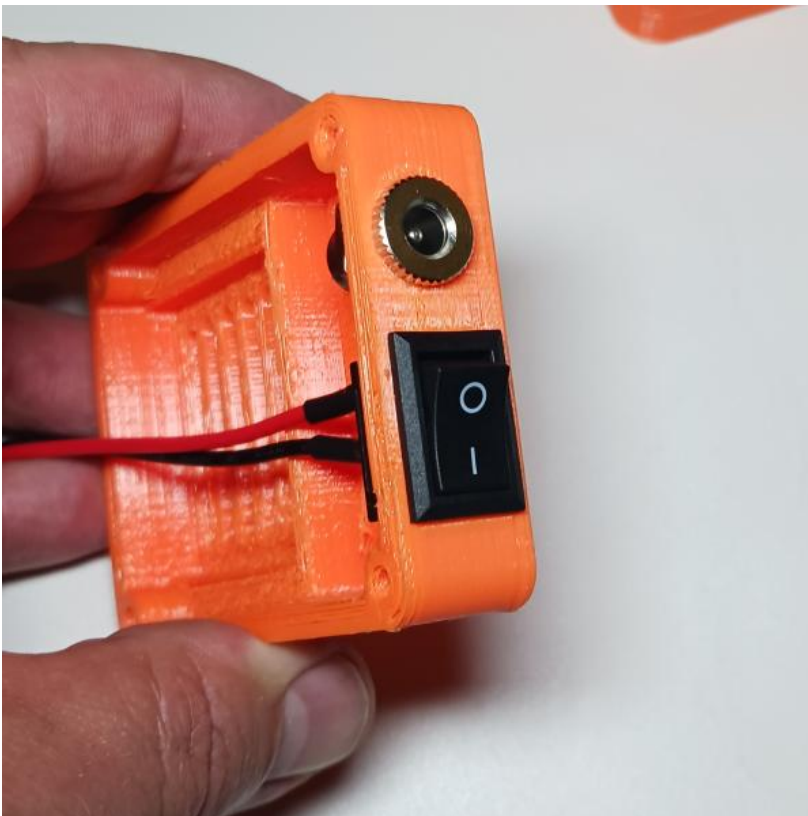

Install rocker switch as shown. Rocker switch will snap into position.

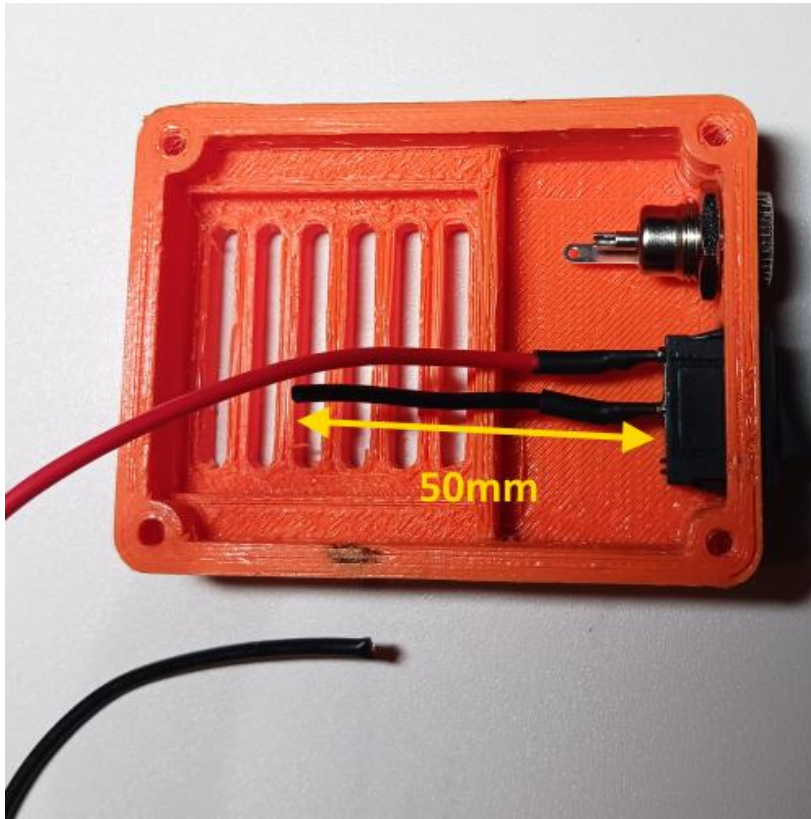

Cut the rocker switch black wire as shown leaving 50mm of wire extended from the rocker switch.

Save the remainder black wire for the next step.

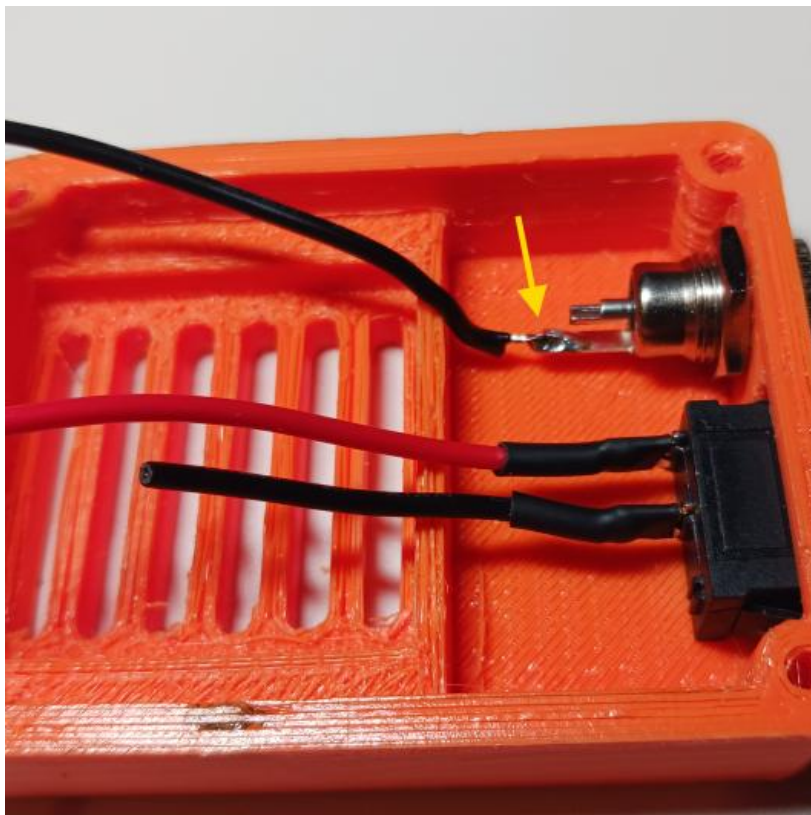

Strip 3mm of sheathing from the end of the black remainder wire and then solder the wire to the 5.5mm power sockets ground connection tab as shown.

NOTE: The ground connection tab is the longer tab coming from the socket outer housing as shown.

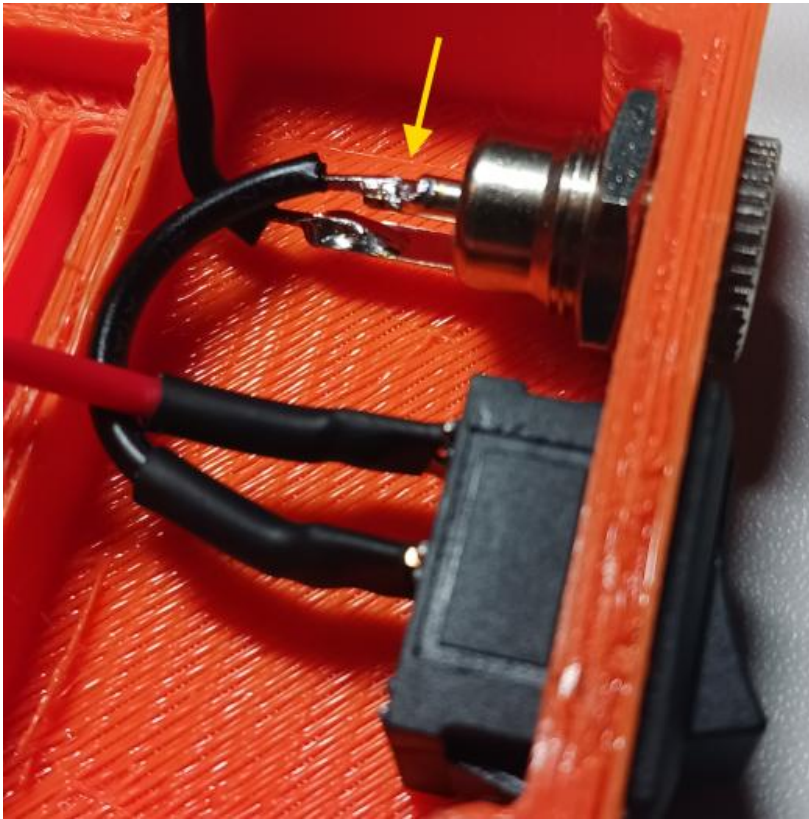

Remove 3mm of sheathing from the rocker switch black wire and then solder the rocker switch black wire to the positive center terminal on the 5.5mm power jack as shown.

NOTE: the positive terminal is the one in the center of the power jack. Make sure solder connections to each of the power jack terminals are solid and that there are no stray strands of wire and that there are no possibilities of a short between the power jack terminals.

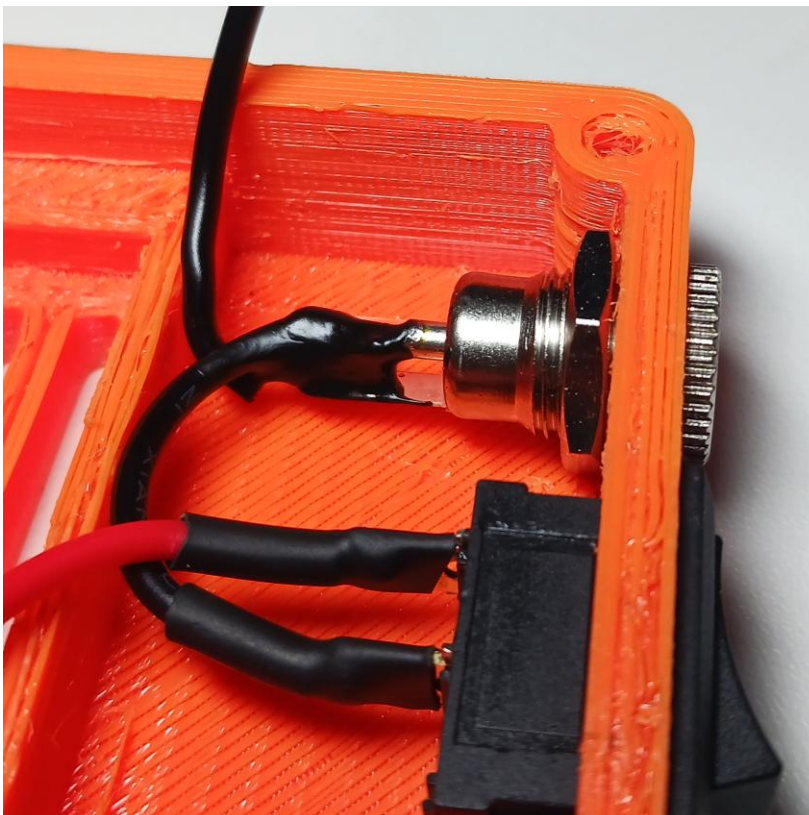

Apply liquid electrical tape to the power jack terminals ensuring there is possibility of a short between the power jack terminals.

NOTE: allow liquid electrical tape to dry and harden completely before moving to the next step.



Insert 40mm cooling fan into housing as shown. The fan label should be facing out.

NOTE: The fan is a snug slip fit into housing and is not secured with any fasteners.

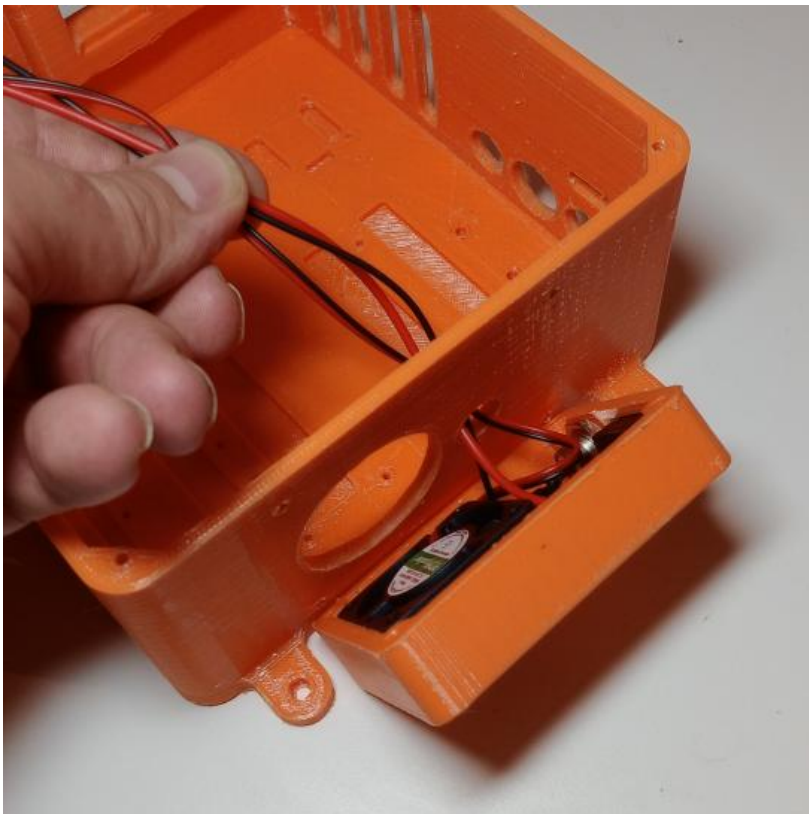

Feed the red and black power wires as well as the cooling fan wires through the auxiliary enclosure access hole as shown.



Secure fan switch cover to the auxiliary enclosure using (4) #6 thread form screws.

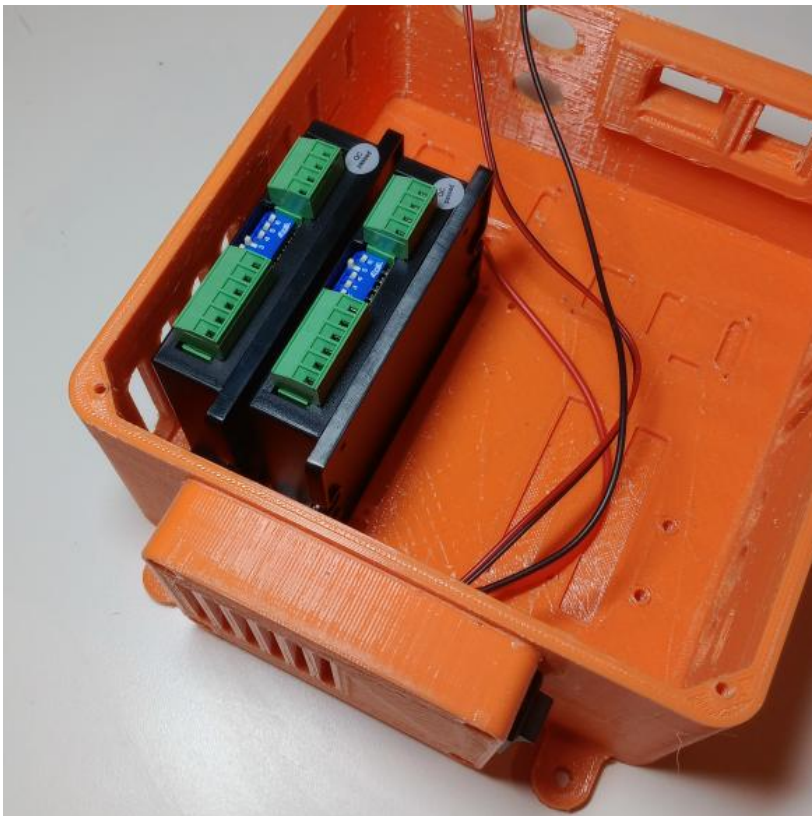

Install the 7th axis and 8th axis drive as shown and secure with #6 thread form screws.

If a 9th axis is desired you can install the next drive just to the right of the 8th axis drive shown.

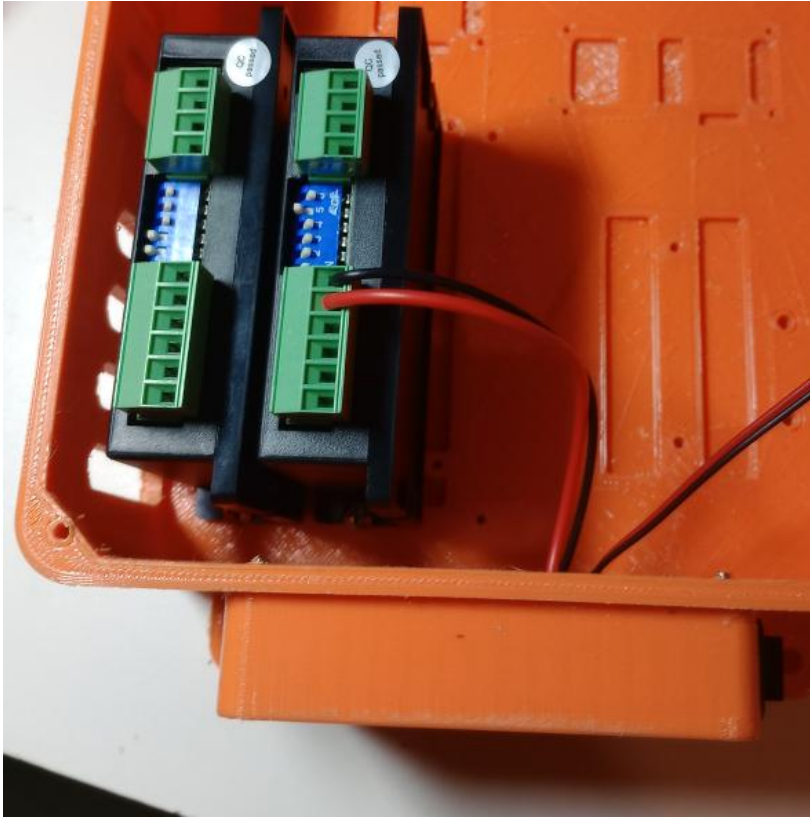

Trim red and black power wires to length shown and then connect the red wire to the +Vdc input, connect the black wire to the GND input on the driver shown.

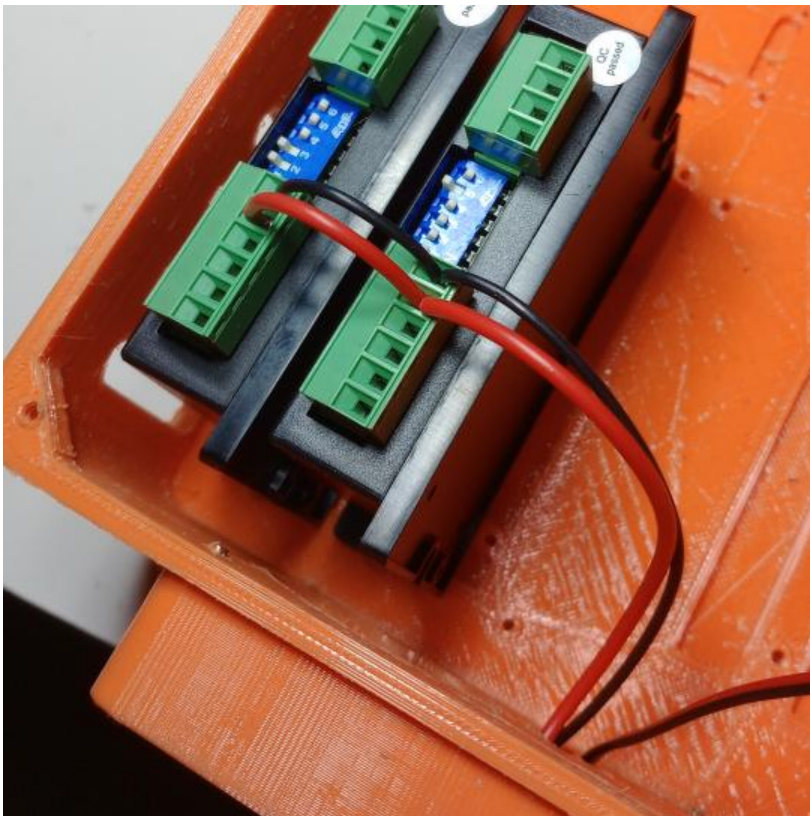

Use the remainder red and black wires to jumper power from the first driver across to the other driver.

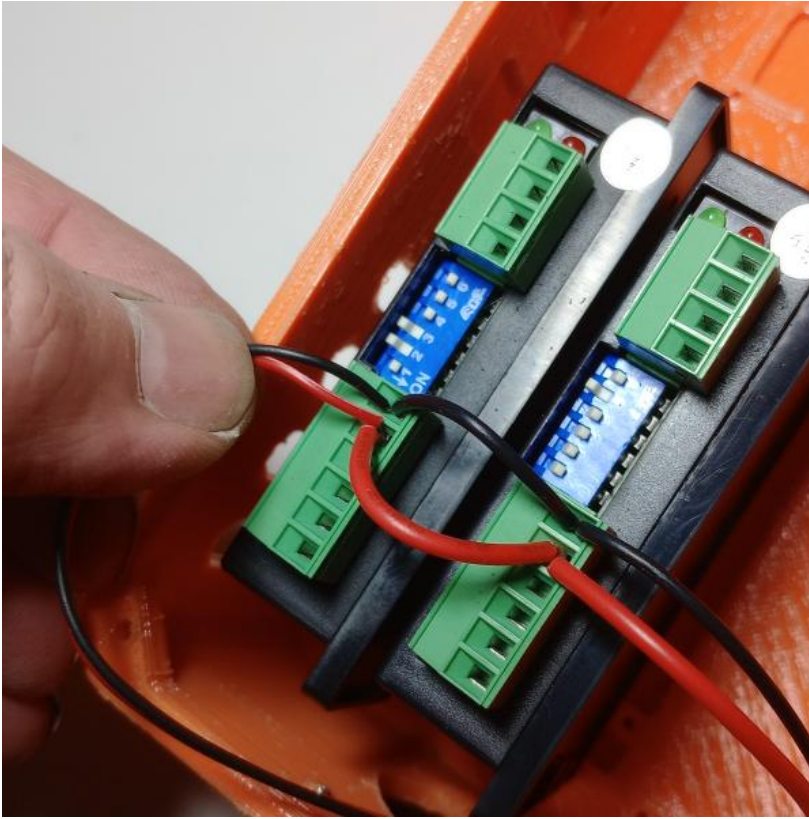

Trim the fan wires to the length shown and then connect the red wire to the +Vdc input and the black wire to the GND input on the last drive as shown.



Cut length of 18awg 4 conductor cable to a length of 20cm long.

You will need one length of cable for each driver.



Remove 3cm of cable jacket on one end and 6cm of jacket from the other end.

Strip all wire ends.

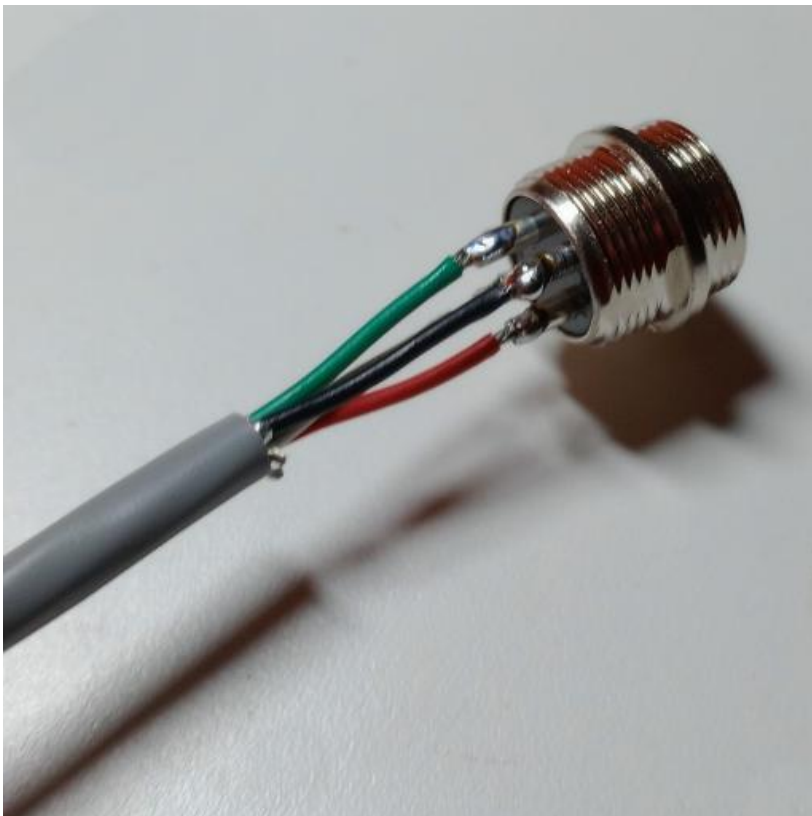

Solder the short end wires to the GX16 terminals as follows:

- #1 – BLACK
- #2 – RED
- #3 – WHITE
- #4 – GREEN

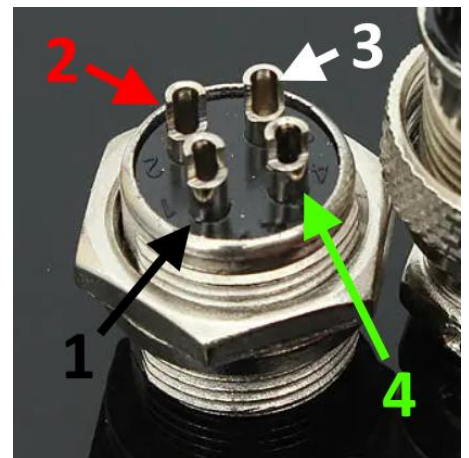

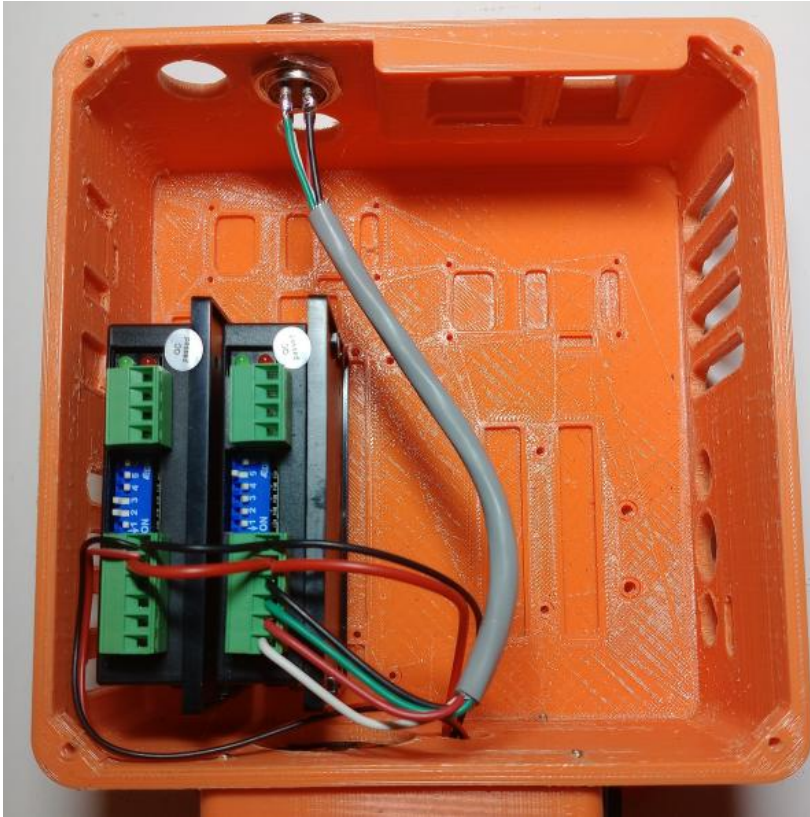

Install the GX16-4 plug into the enclosure as shown.

Connect the (4) J2 motor wires to the first driver terminals as follows:

A+ BLACK

A- GREEN

B+ RED

B- WHITE

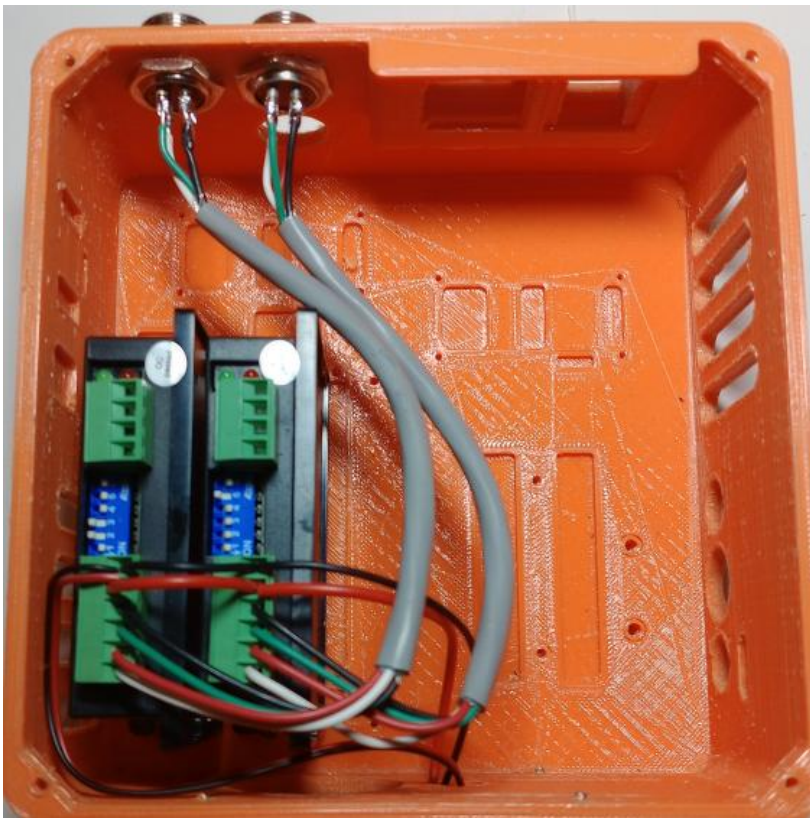

Repeat the last 3 steps and install GX16-4 plug for the 2nd drive.

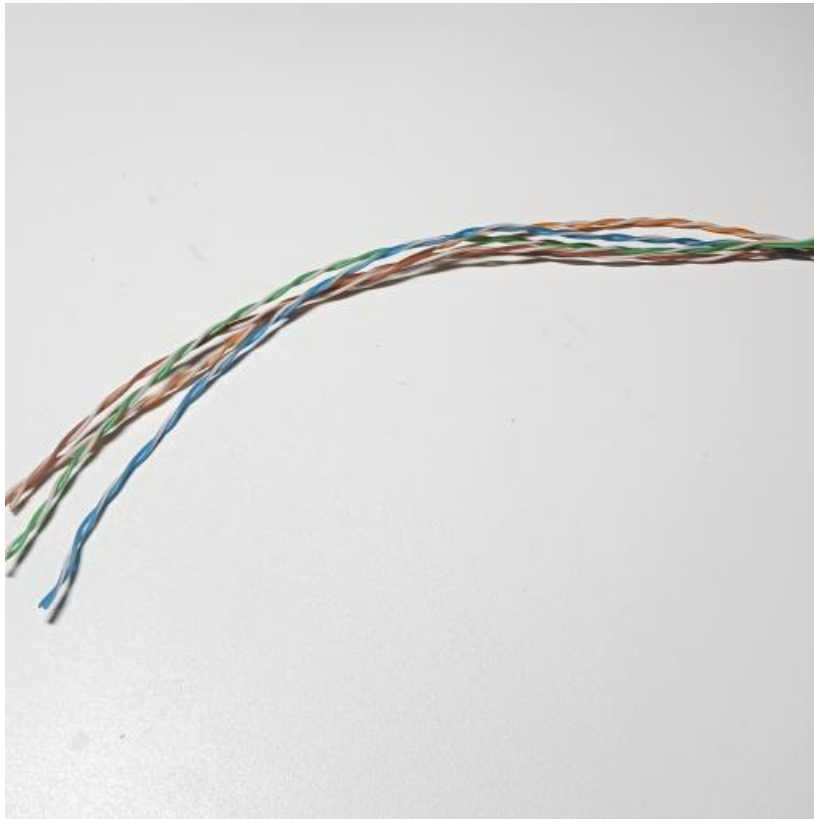

Cut Cat5 cable to length of 15cm and remove outer sheathing from cable.

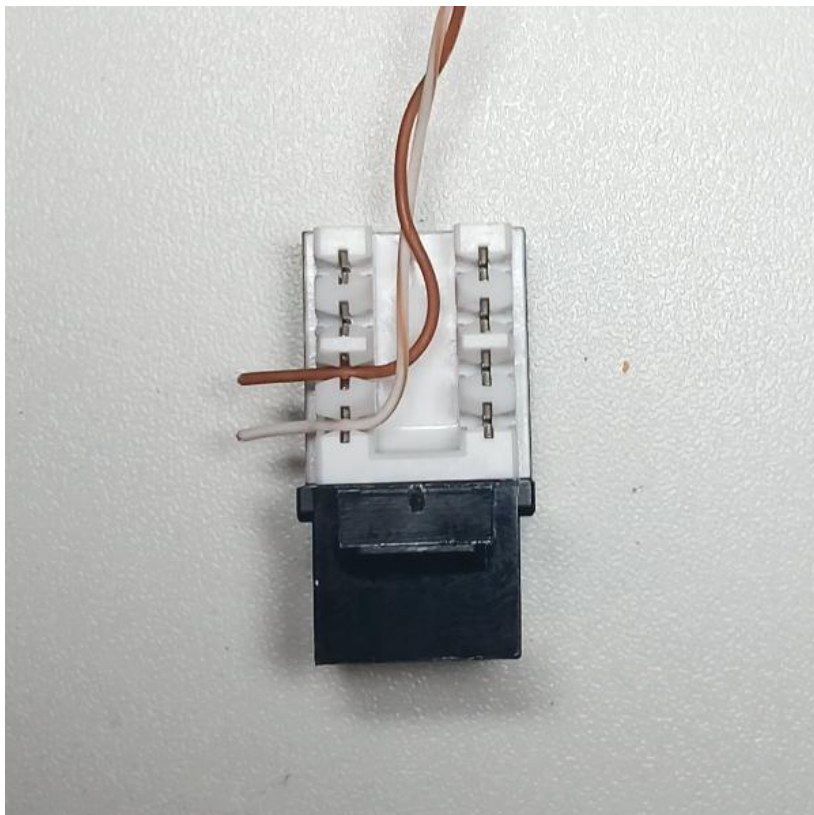

Insert the brown stripe wire into terminal #7 of the CAT6 Keystone Jack.

Insert the solid brown wire into terminal #8 of the CAT6 Keystone Jack.

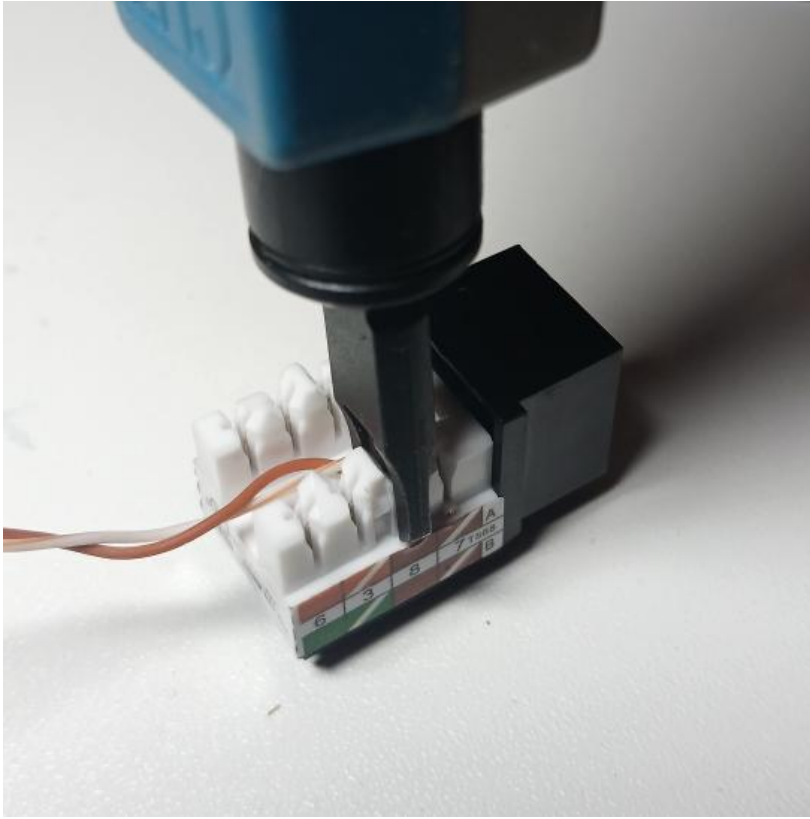

Use a keystone punch down tool to seat and trim both wires into the CAT6 Keystone Jack.

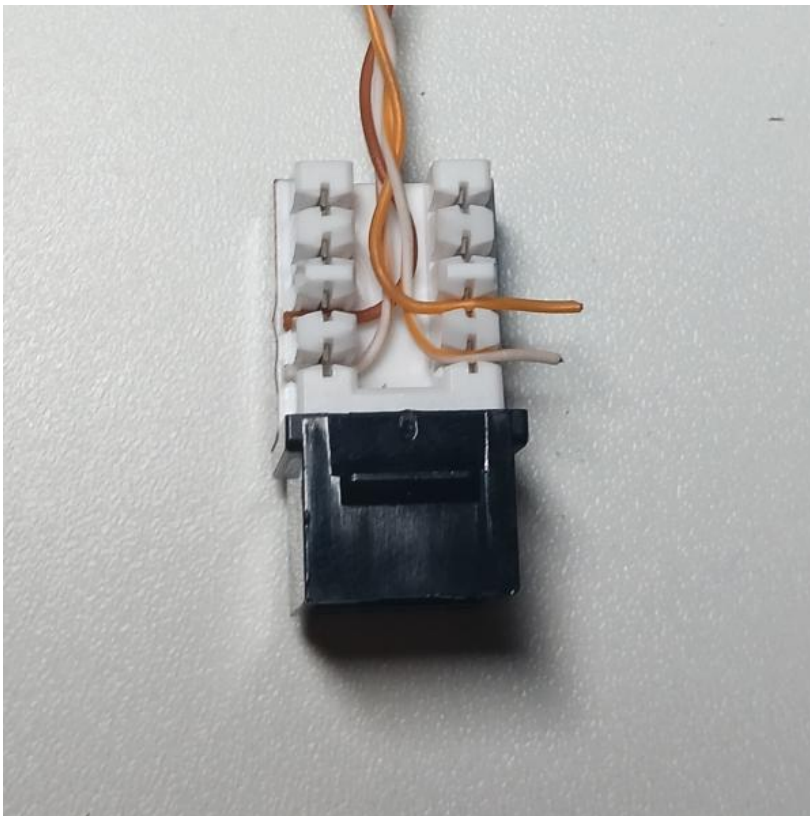

Insert the orange stripe wire into terminal #1 of the CAT6 Keystone Jack.

Insert the solid orange wire into terminal #2 of the CAT6 Keystone Jack.

Then use a keystone punch down tool to seat and trim both wires into the CAT6 Keystone Jack.

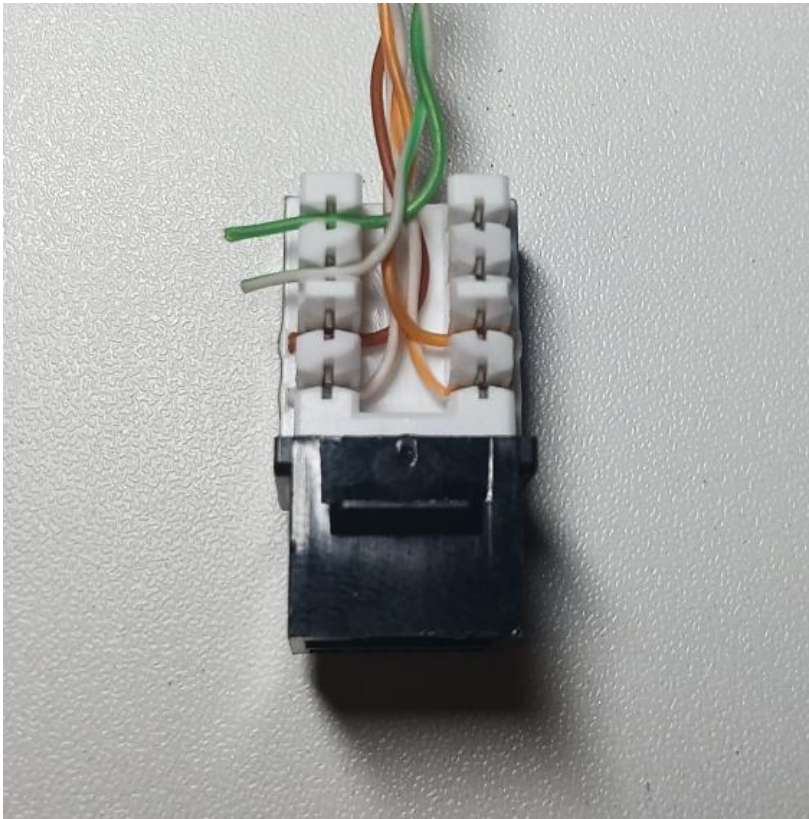

Insert the green stripe wire into terminal #3 of the CAT6 Keystone Jack.

Insert the solid green wire into terminal #6 of the CAT6 Keystone Jack.

Then use a keystone punch down tool to seat and trim both wires into the CAT6 Keystone Jack.

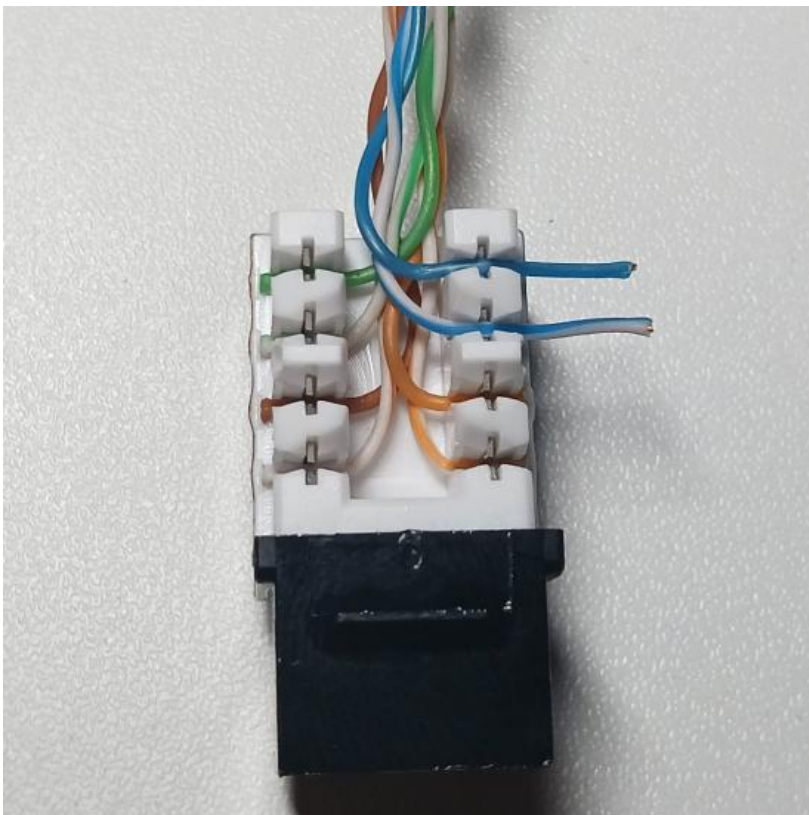

Insert the blue stripe wire into terminal #5 of the CAT6 Keystone Jack.

Insert the solid blue wire into terminal #4 of the CAT6 Keystone Jack.

Then use a keystone punch down tool to seat and trim both wires into the CAT6 Keystone Jack.



Install keystone jack into left socket in enclosure as shown.

Connect the green wire to the OPTO input on the J7 driver, then jumper a green wire from the J7 driver to the J8 driver.

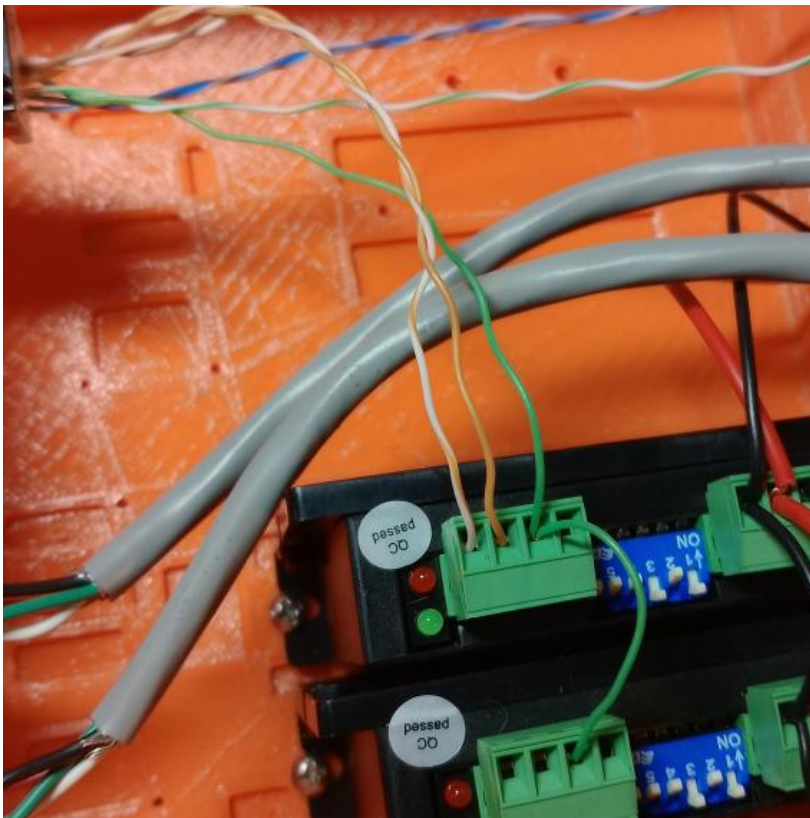

Connect the solid orange wire to the DIR input on the J7 driver.

Connect the orange stripe wire to the PUL input on the J7 driver.

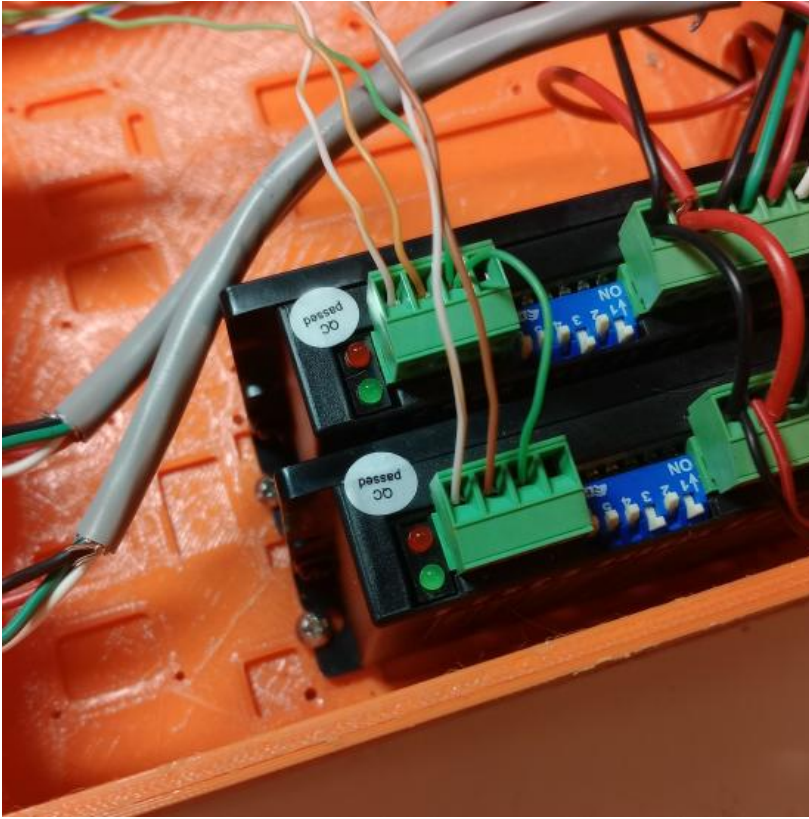

Connect the solid brown wire to the DIR input on the J8 driver.

Connect the orange stripe wire to the PUL input on the J8 driver.

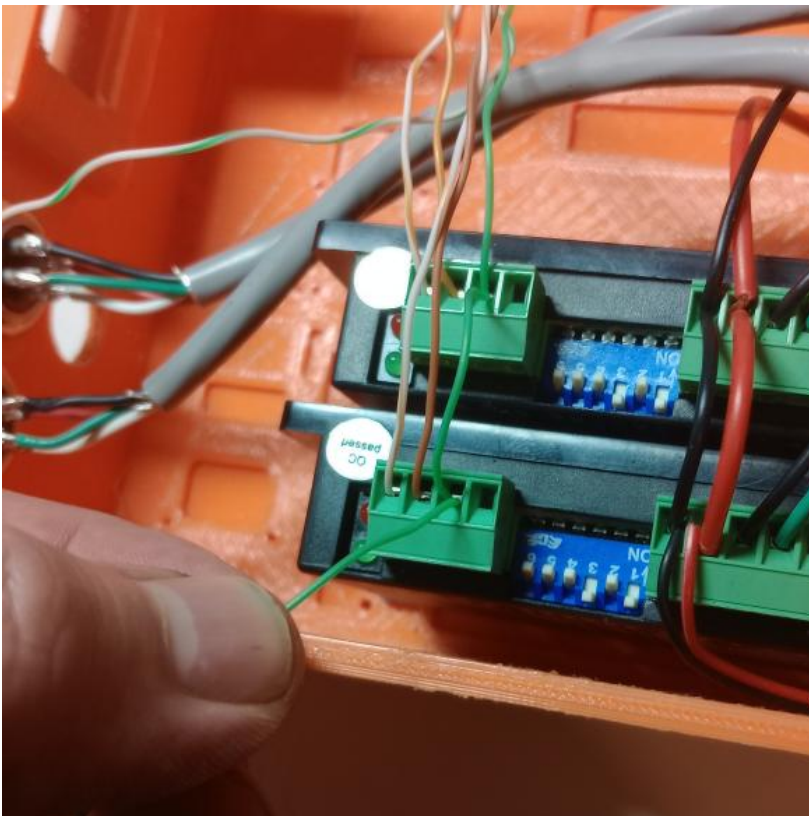

Connect 15cm long green jumper wire to the J

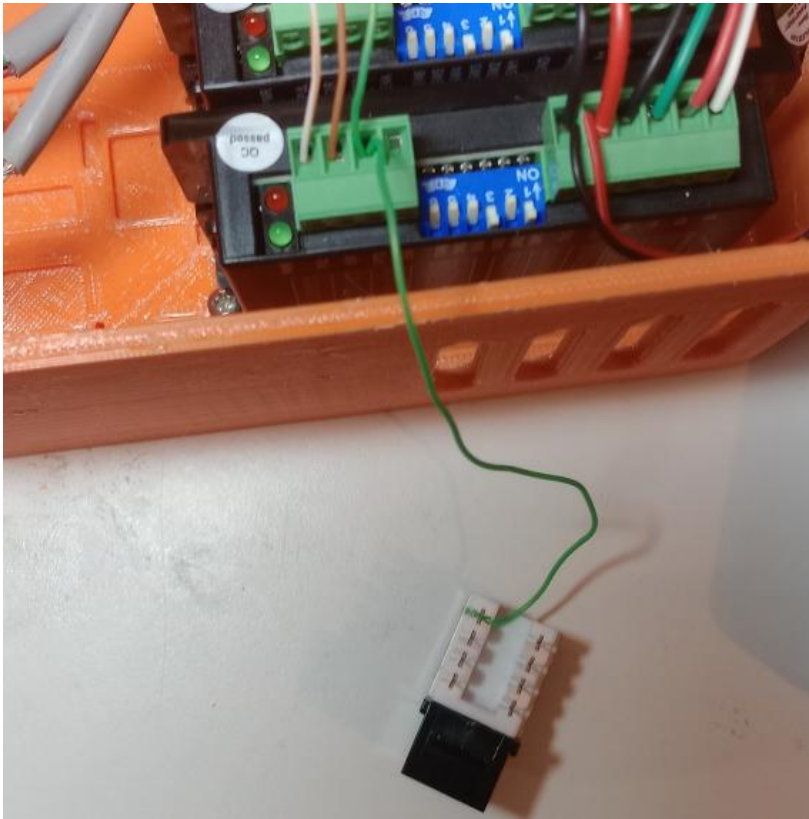

Use keystone punch down tool to secure the solid green jumper wire to terminal #6 on keystone jack.

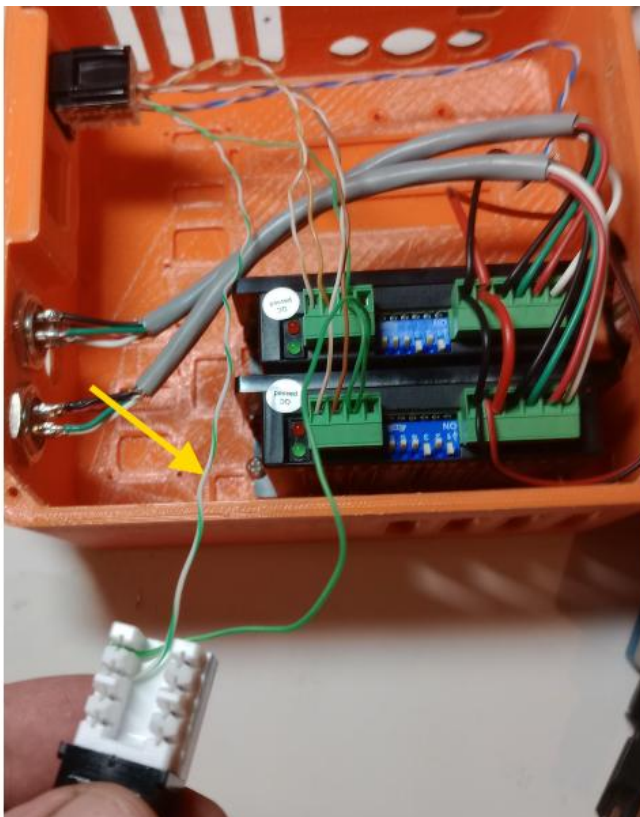

Use keystone punch down tool to secure the green stripe wire from the first keystone jack to terminal #3 on the second keystone jack.

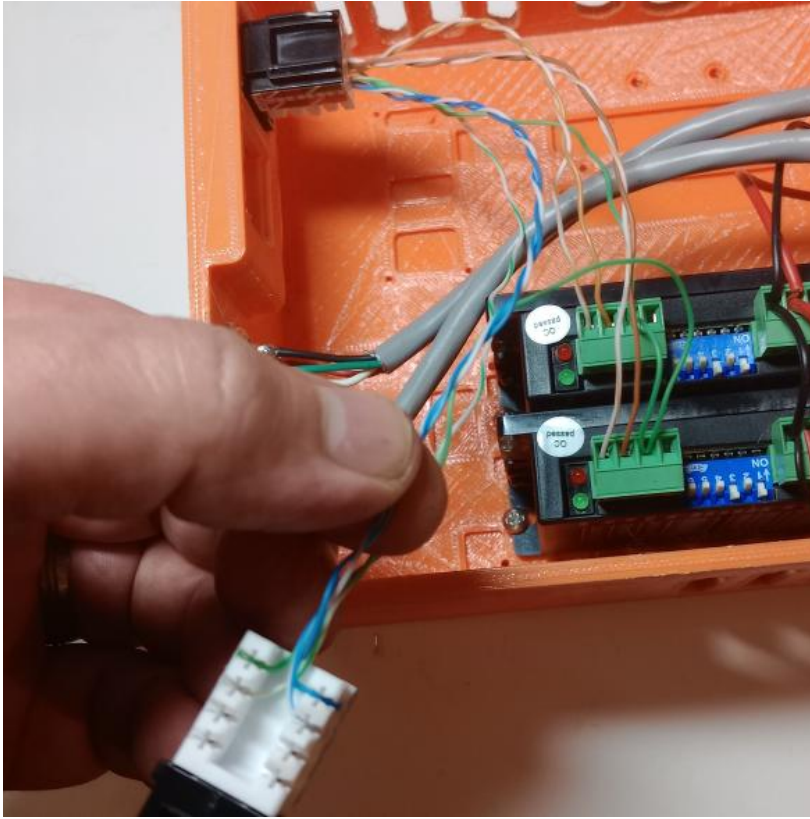

Use keystone punch down tool to secure the solid blue wire from the first keystone jack to terminal #4 on the second keystone jack.

Secure the blue stripe wire from the first keystone jack to terminal #5 on the second keystone jack.

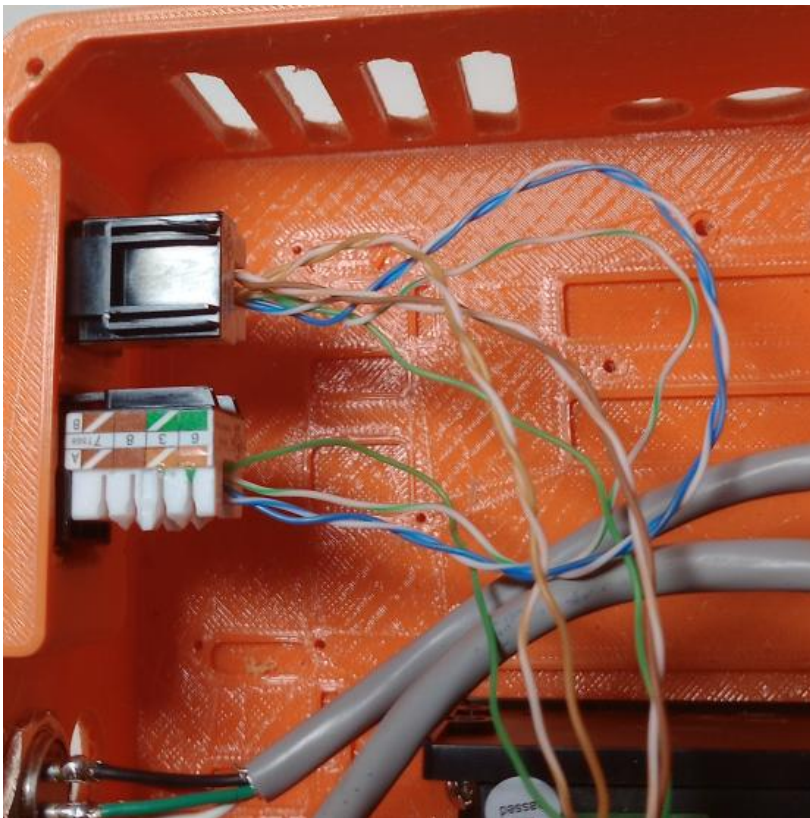

Install second keystone jack in enclosure as shown.

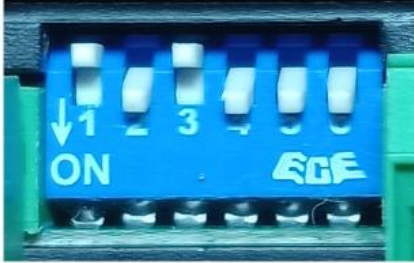

NEMA 17 SETTING FOR DM332T

You will need to set the drives dip switch settings. If your 7th or 8th axis is a nema 17 motor as shown in this chapter then use the same driver settings as the robot uses for joint 1 or joint 3. If you have selected a different motor for your additional axis you will need to consult the motors manual to determine the correct settings.



Install enclosure lid and secure with (4) #6 thread form screws.



Place template on corner of aluminum plate as shown and then use spring loaded center punch to mark the 4 holes. Rotate and flip template to each corner and repeat until all 16 holes are marked.



Drill all 16 holes to clearance 5mm screw.



Countersink all 16 holes.



Draw centerline on aluminum plate as shown.





Place drive mount on plate aligned on centerline. Use spring loaded center punch to mark (x4) holes.



Drill and tap (x4) M4 holes as shown.



Center J1 base enclosure as shown and mark (x4) mounting holes.

(note this is an older picture from the AR2 base)

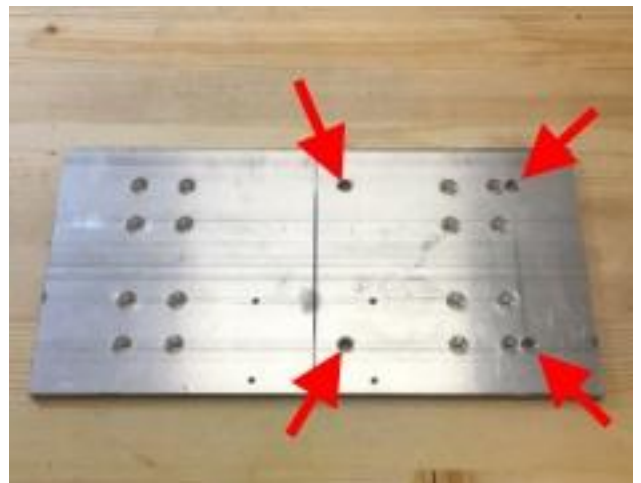

Drill and tap (x4) M8 holes as shown.



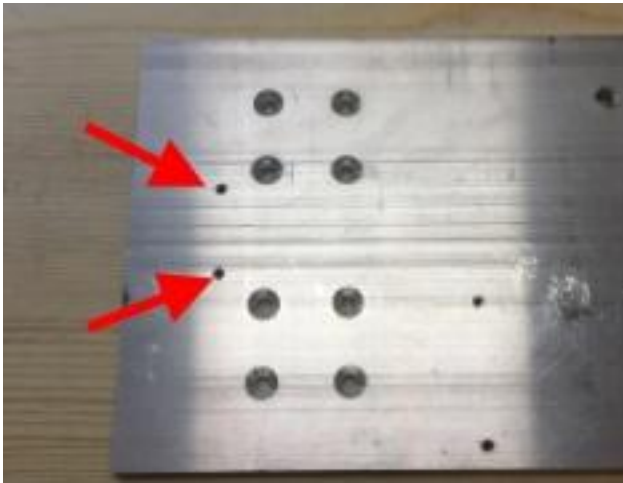

Drill and tap (x2) M4 holes centered 30mm apart and 30mm from edge as shown.

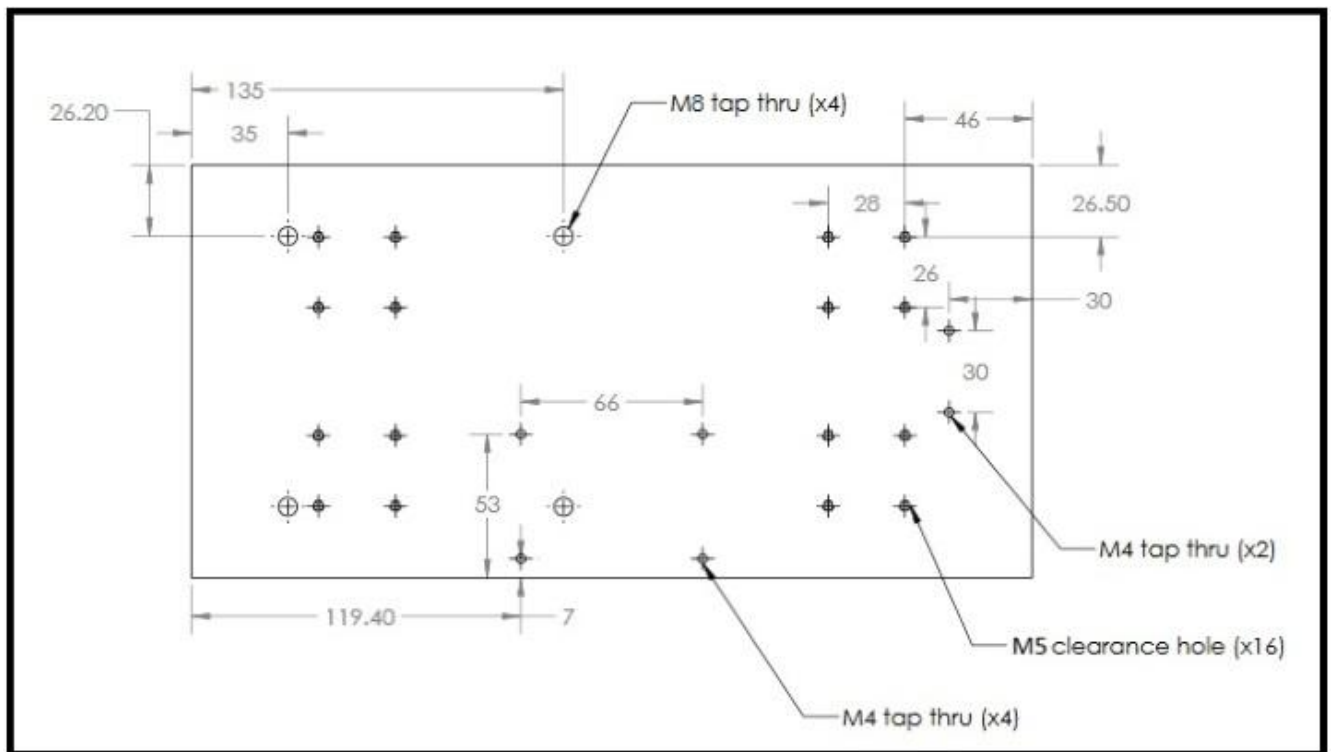

When complete aluminum plate should be drilled as shown in this drawing.





Install (x4) linear bearings with block spacers between aluminum plate and bearing as shown. Secure with (x16) M5x20 flat head screws. (do not fully tighten M5 screws yet)



Secure drive mount assembly to aluminum plate as shown using (x4) M4x20 socket head cap screws.

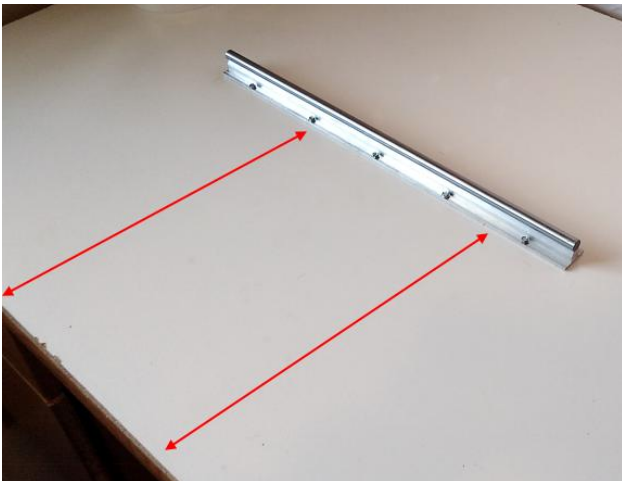

Mount the first rail to your table or workspace. Make sure rail is parallel to table (red arrows) and positioned where you want it. Secure rail with screws in each mounting hole using wood screws or cap screws depending on the surface you are mounting to.



Slide 2nd rail into rear pair of linear bearings as shown.



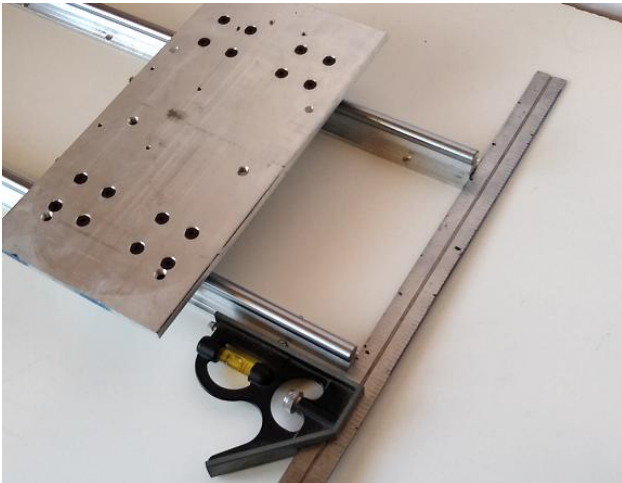

Slide aluminum plate & front pair of linear bearing onto the front rail which is secured to table. The rear rail is still free – use square to make sure rear rail is aligned with front rail.

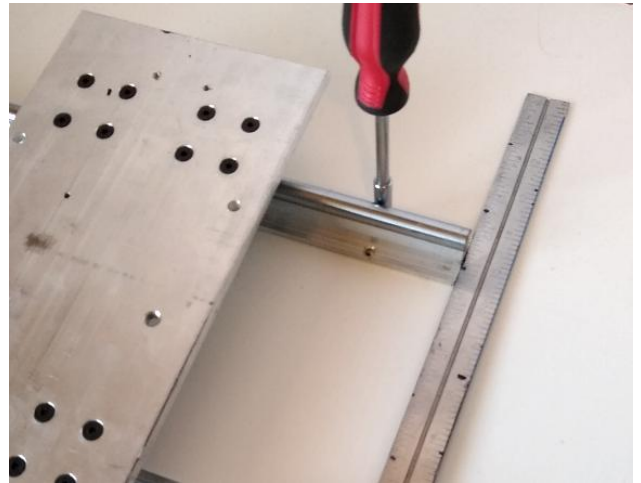

Secure rear rail with screws in each mounting hole using wood screws or cap screws depending on the surface you are mounting to.



Install T8 screw, bearing and motor coupler as shown.





With platform at maximum travel to the left side secure lead screw bearing and bearing spacer to work table as shown.

Tighten bearing and coupler set screws.



Turn screw manually and drive platform to far end. Secure opposite lead screw bearing and bearing spacer as shown at very end of screw.

Tighten bearing set screws.



Note that the drive mount should bottom out against the bearing and not allow the platform to go off the end of the rails.

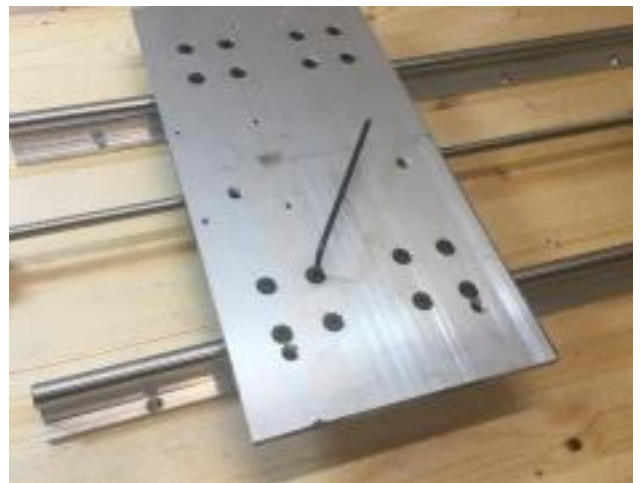

Make sure platform moves smoothly and easily down rails and then tighten the (x16) M5 screws securing platform to rail bearings.





Temporarily install motor and bracket and use pencil to mark motor mount location.



Remove motor and secure motor mount to work table as shown.



Reinstall motor using (x4) M3x10 socket head cap screws.

Tighten shaft coupler set screws.

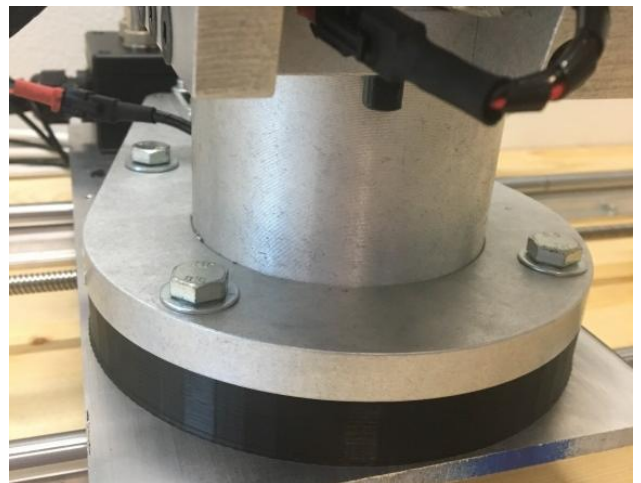

Secure robot to platform using (x4) M8x35 metric bolts.



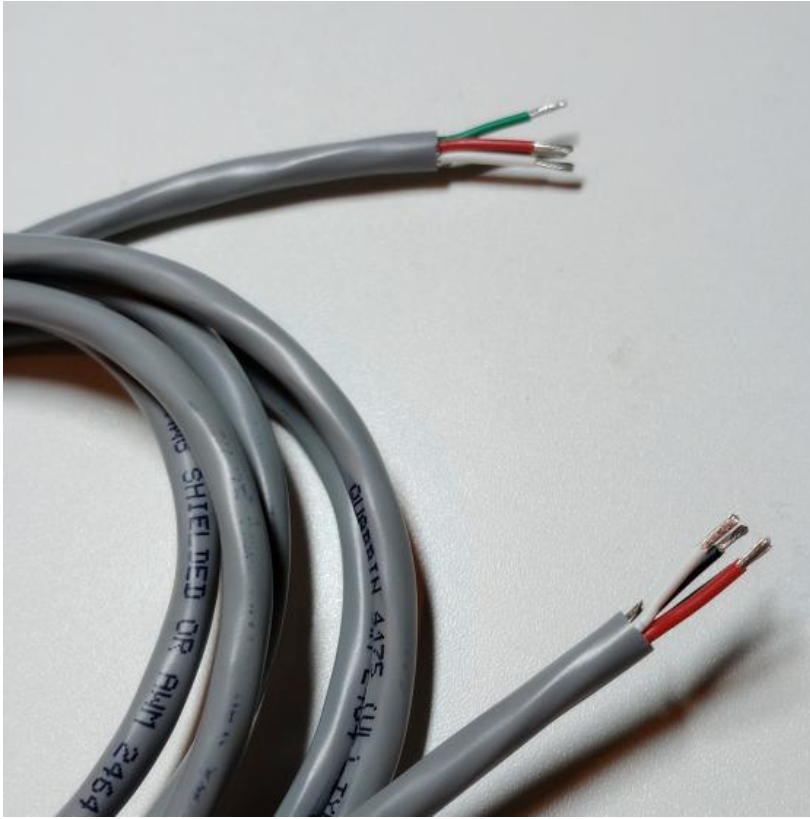

Remove 1.5cm of the jacket from each end of the remaining 175cm long 4 conductor cable.

Next strip the end of each individual wire as shown.

Remove the screw and cover from (1) female GX16-4 connectors.

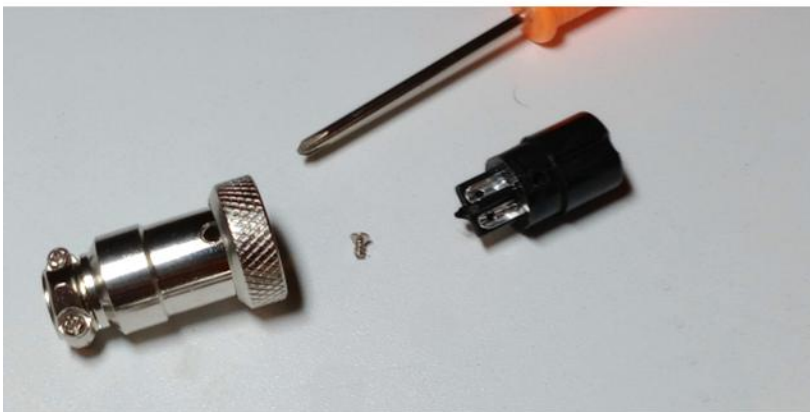

Slide GX16 connector cover over the end of the cable as shown.

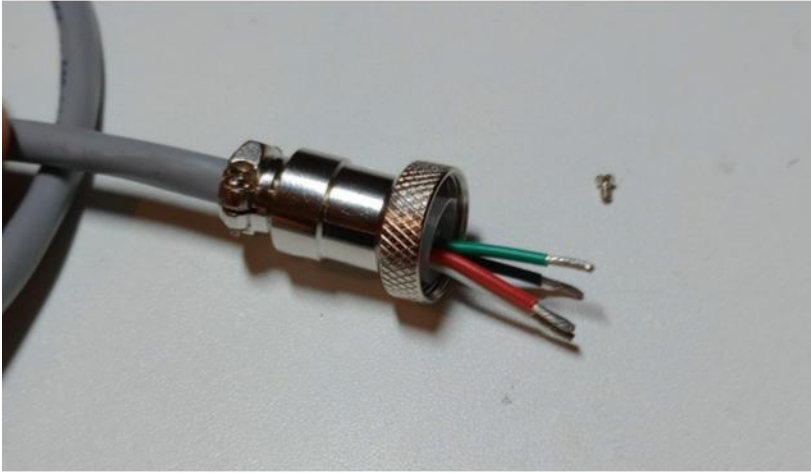

Solder the cable wire to the GX16 terminals as follows:

#1 – BLACK

#2 – RED

#3 – WHITE

#4 – GREEN

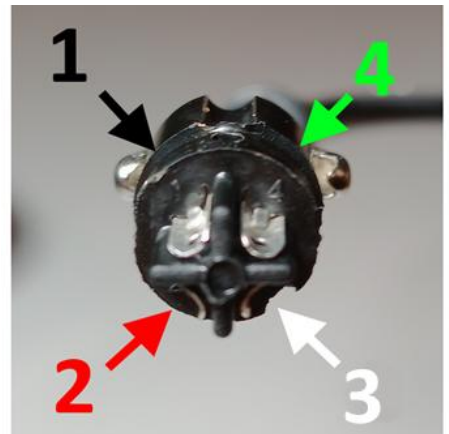



Reinstall connector cover, install retaining screw and tighten the cable clamp.



Slide a 6 to 8cm long piece of 6mm heat shrink tubing over the other end of the cable.

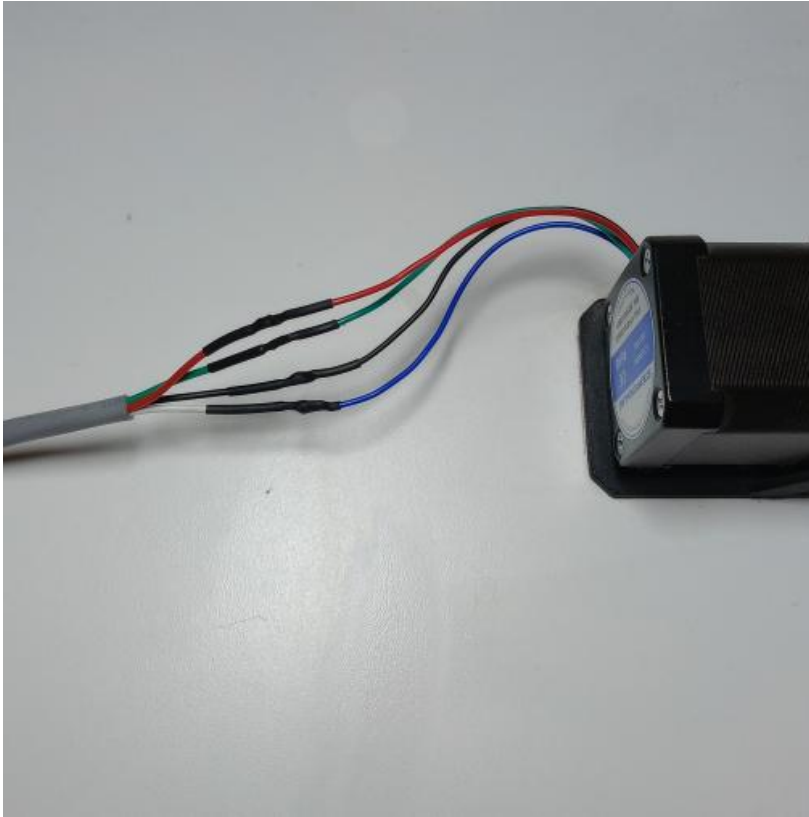

Solder and heat shrink the cable wires to the motor wires as follows:

- **Motor Red to cable Red**
- **Motor Green to cable Green**
- **Motor Black to cable Black**
- **Motor Blue to cable White.**



Slide larger 6mm heat shrink tube over the individual connections and apply heat to shrink tubing.

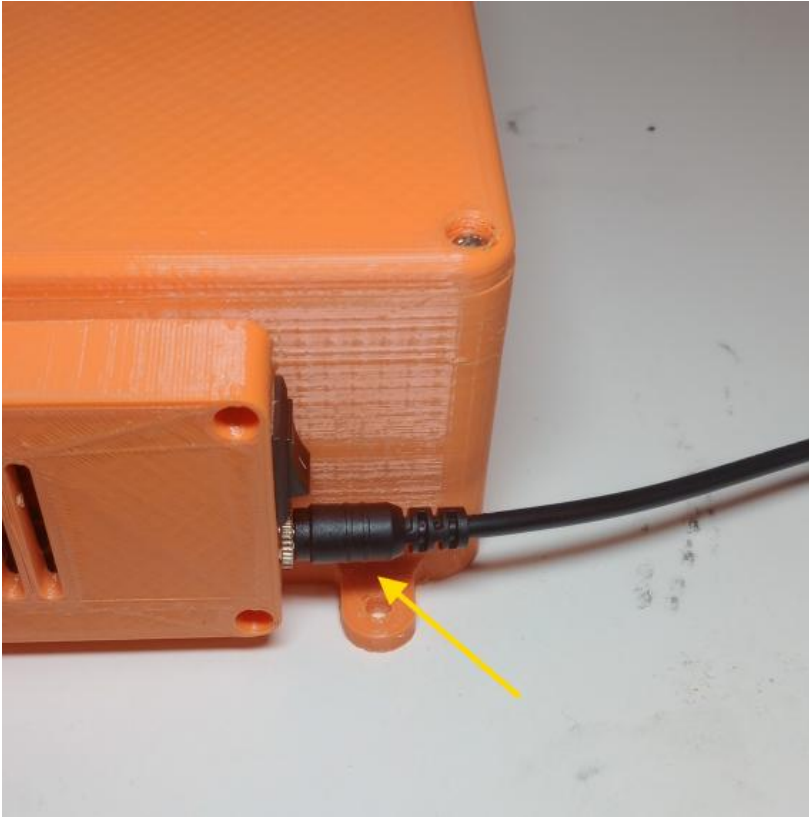

Connect 24vdc power supply to auxiliary enclosure.



Connect Ethernet cable from left jack to the robot.

With the robot powered on and the auxiliary enclosure powered on you should now be able to jo

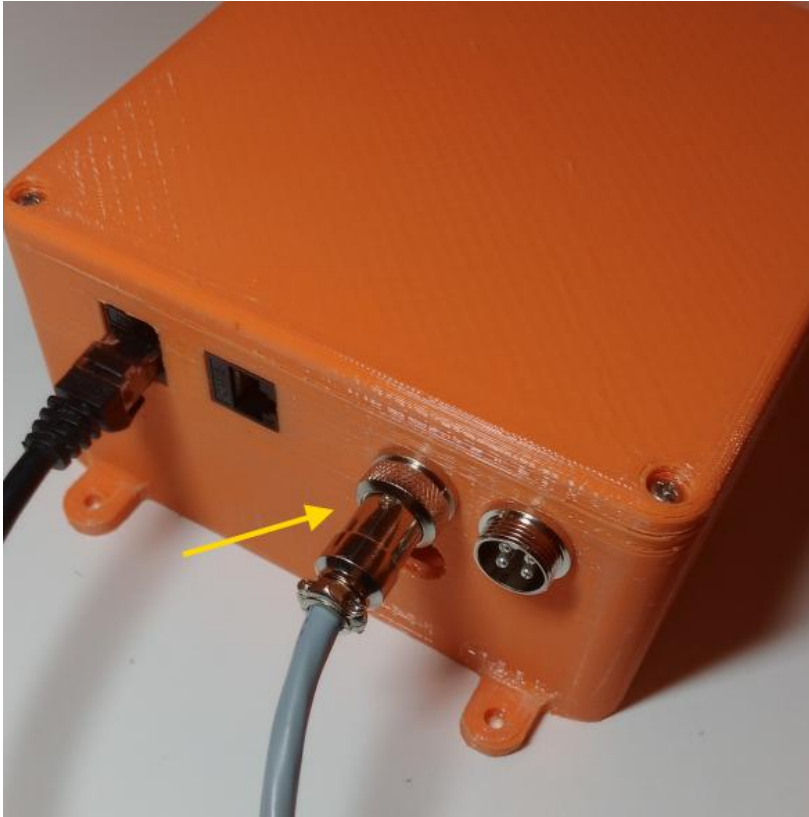

Connect motor cable to auxiliary enclosure GX14 socket for axis 7.

With the robot and auxiliary enclosure both powered on you should now be able to jog the 7th or 8th axis from the robot control software.

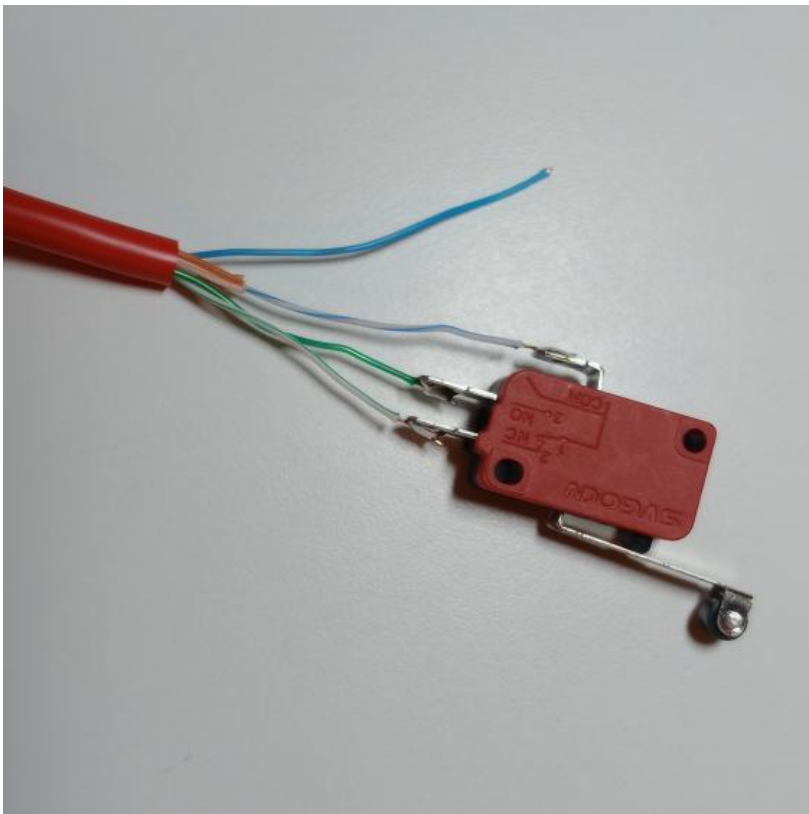

If you would like to add a homing switch or calibration switch to your auxiliary axis you will need to either fabricate an ethernet cable or just cut the end off of an inexpensive cable then solder connections as follows:

- Green stripe wire to NC terminal
- Solid green wire to NO terminal
- Blue stripe wire to COM terminal

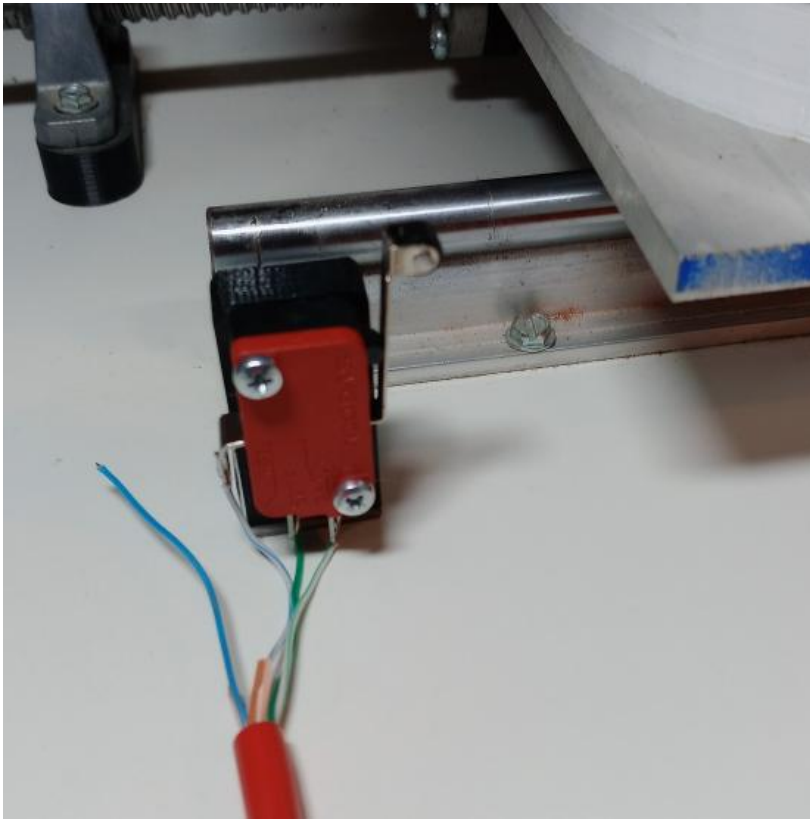

Mount the limit switch in whatever position you need for your additional axis.

Note the blue wire is for a limit switch for axis 8. You will need to jumper or extend the solid and stripe green wires to any additional limit switches.

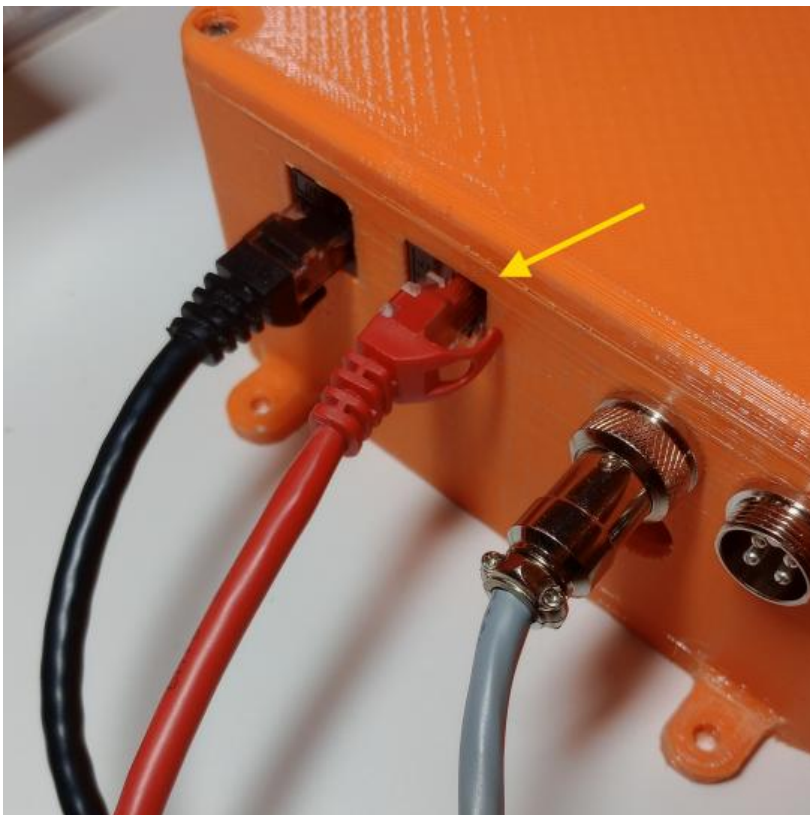

Plug the limit switch ethernet cable into the second jack in the auxiliary enclosure.

You should now be able to home or calibrate your additional axis.

Note: If you need a 9th axis you will need to run separate wires for the step and direction signals as the left keystone jack only has capacity for the 7th and 8th axis.

CHAPTER 7

ROBOT SPECIFICATIONS & DIAGRAMS



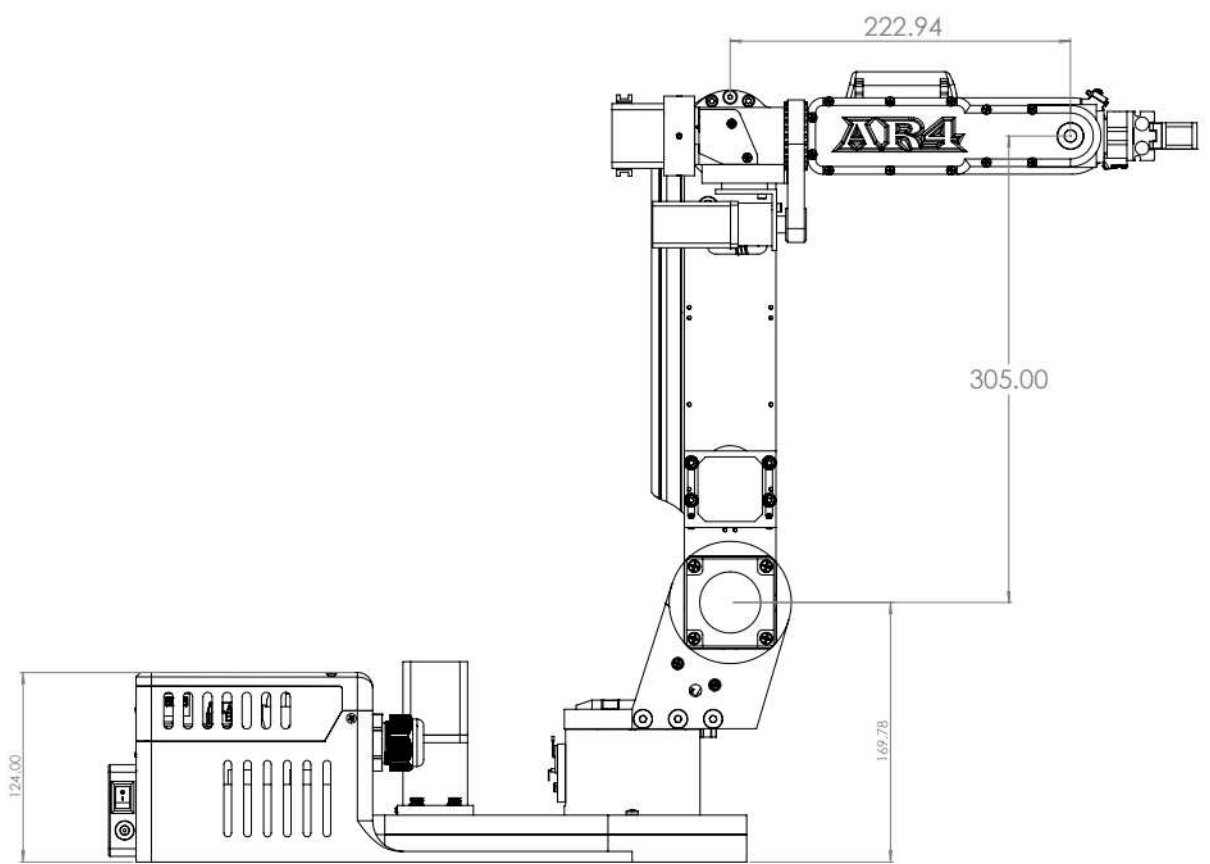
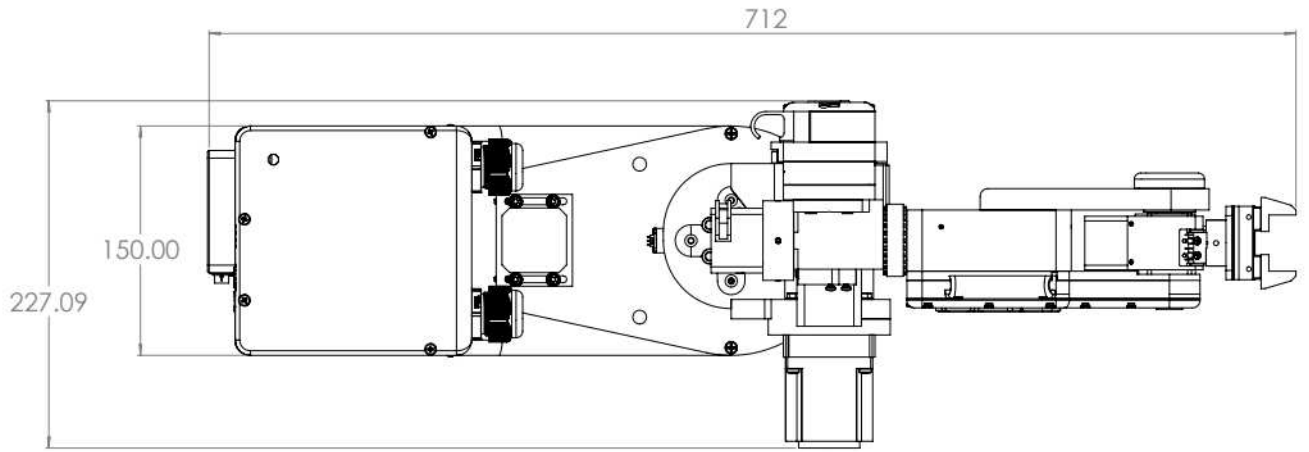

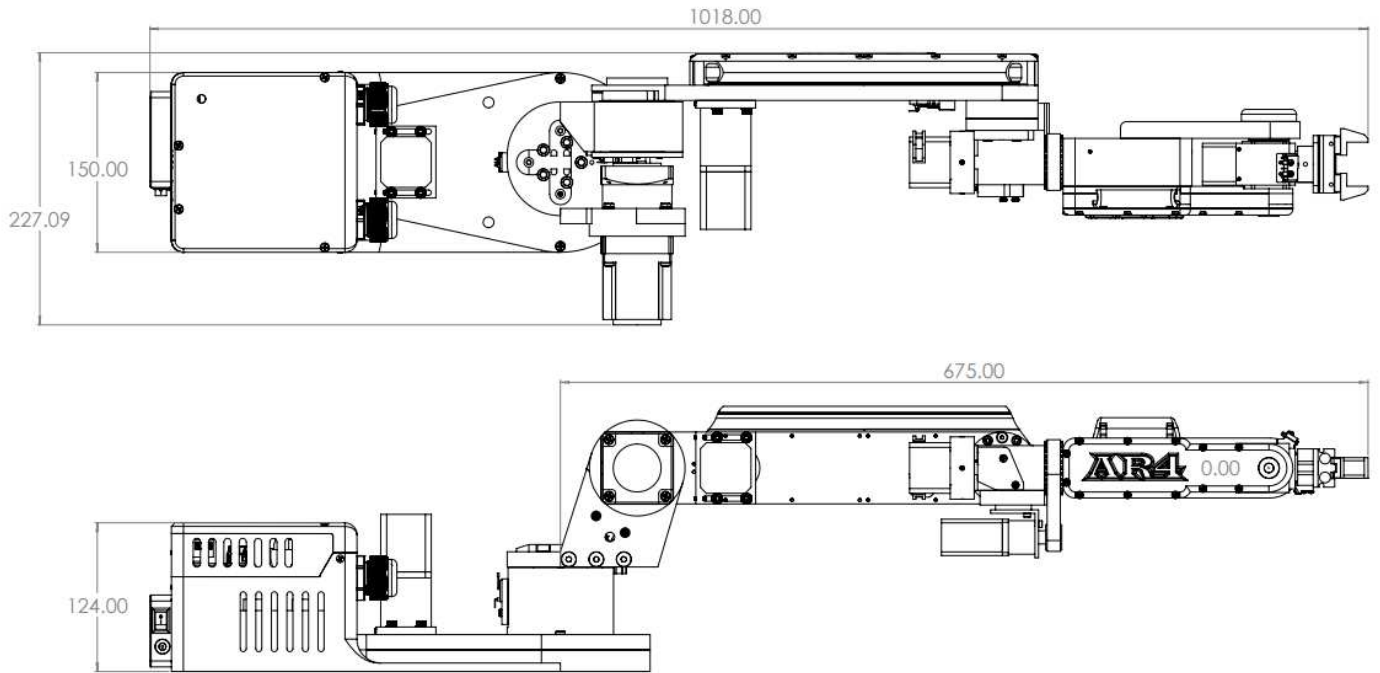

Reach – 26.5 inches (675mm)

Payload – 4.15 lbs (1.9kg)

Repeatability - .25 mm

Robot weight (aluminum) – 27lbs (12.25kg)

Max Power Consumption – 8.25amp (198 watts)



AR4 WIRING SCHEMATIC

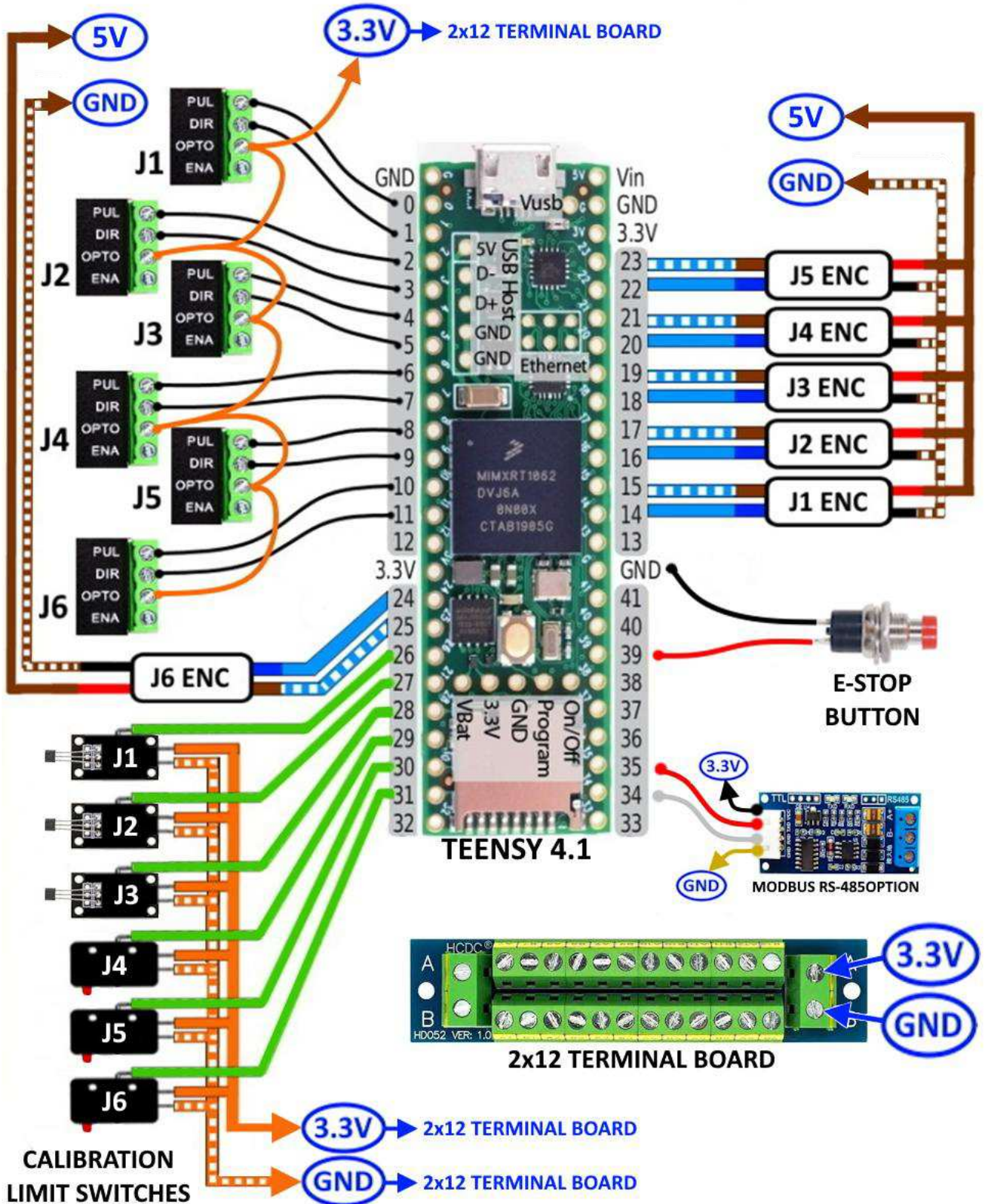

NANO WIRING FOR PERIPHERAL INPUT OUTPUTS AND GRIPPER CONTROL

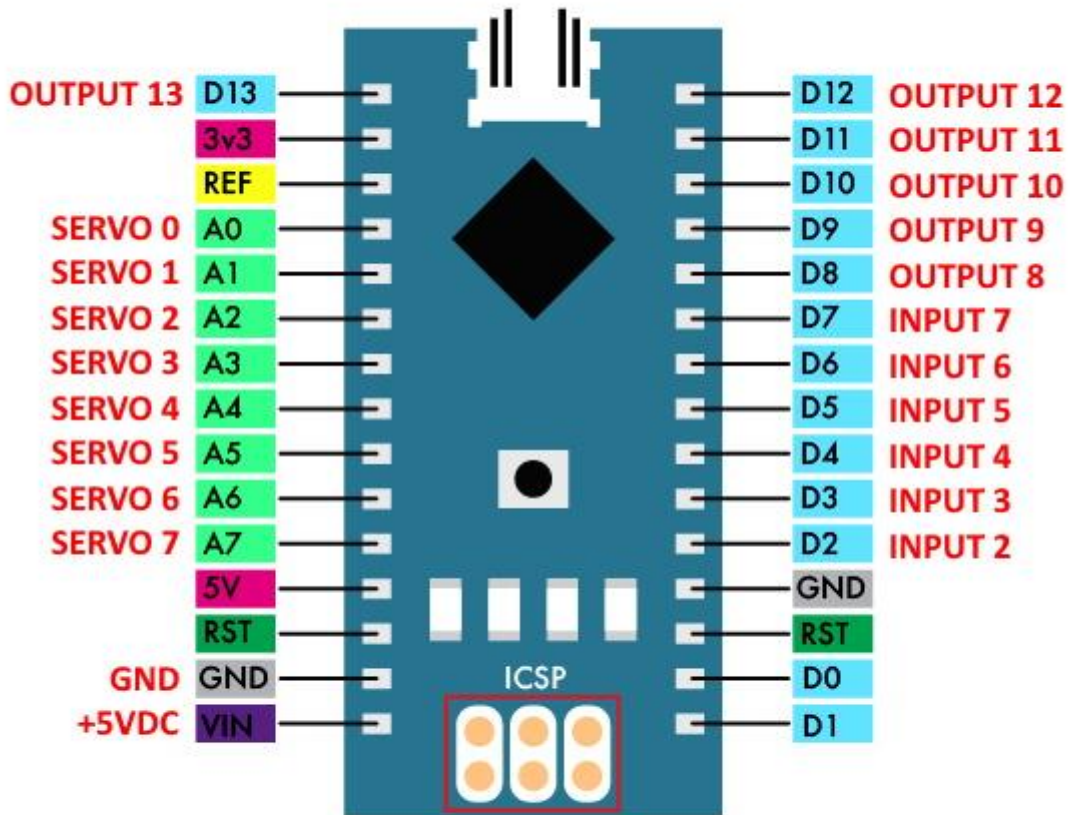

CHAPTER 8

STARTUP PROCEDURE

Please see the AR4 startup tutorial video:

<https://youtu.be/yM0rBT2chiY>

If you have any issues connecting your teensy board to the software please also review the Teeny troubleshooting page here:

<https://www.pjrc.com/teensy/troubleshoot.html>

Before powering up your robot double check all connections per the wiring schematic. Check continuity on all wires and connectors for each motor, encoder and limit switch. It is imperative that all wire connectors are crimped or soldered carefully and checked with a volt meter.



- Review the AR4 software startup video found on the tutorials page at www.anninrobotics.com and install the latest **AR4 teensy 4.1 sketch** on your teensy board (*You will need to install the **ModbusMaster** & **Arduinojson** library in the Arduino IDE*) and load the AR4 control software on your computer or laptop.
- After starting up the AR4 control software verify the log screen shows the message “**COMMUNICATIONS STARTED WITH TEENSY 4.1 BOARD**” and the system message at the top of the main control screen says “**SYSTEM READY**”.
- The first step is to check that each motor runs and jogs in both directions. At this point we do not yet want to troubleshoot any encoder issue or have any potential encoder issues cause confusion when checking the motors. For now select the checkboxes on the Config Settings tab to disable all the encoders:

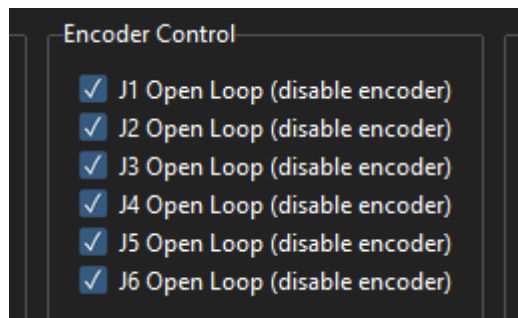

- On the Main Control screen jog each motor a small amount in each direction – set the jogging step value to 10 and press the + and – button for each joint.

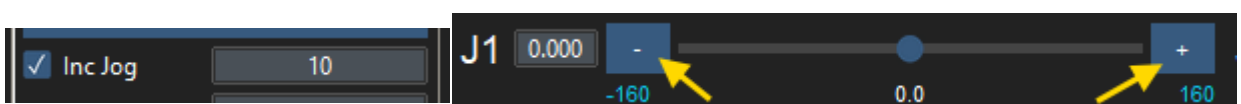

- If any of the motors do not move at all there are generally 2 things to look for, first check the motor power wiring for the A+A-B+B- wires, this includes checking the wiring between the drivers and the sockets, checking the cables, try swapping motor cables with a known good cable, check the plug wiring in the base of the robot. The second thing to check is the pulse wire from the teensy to the affected driver – if the driver is not getting the pulse signal it will not move in either direction.
- If one of the motors only jogs in one direction this is typically an issue with the dir wire from the teensy to the affected driver – check that this wire is properly connected.
- Another very common issue is not having 3.3v at each OPTO terminal due to a bad wire connection – **make absolutely sure** you have 3.3v at each drivers terminal. The joints can sometimes still run and exhibit very strange behavior if the 3.3v connection is bad.
- After it is verified that all motors can jog in each direction it is important to check that each motor is jogging in the correct directions for the positive and negative directions, it is possible for miswiring of the A+A-B+B- to cause the motors to turn in the incorrect directions. Refer to the following diagram and verify each joint is jogging in the correct direction. If any of the motors are not jogging in the correct direction check the motor wiring and verify if you are using a different driver that is doesn't have a direction dip switch set incorrectly.



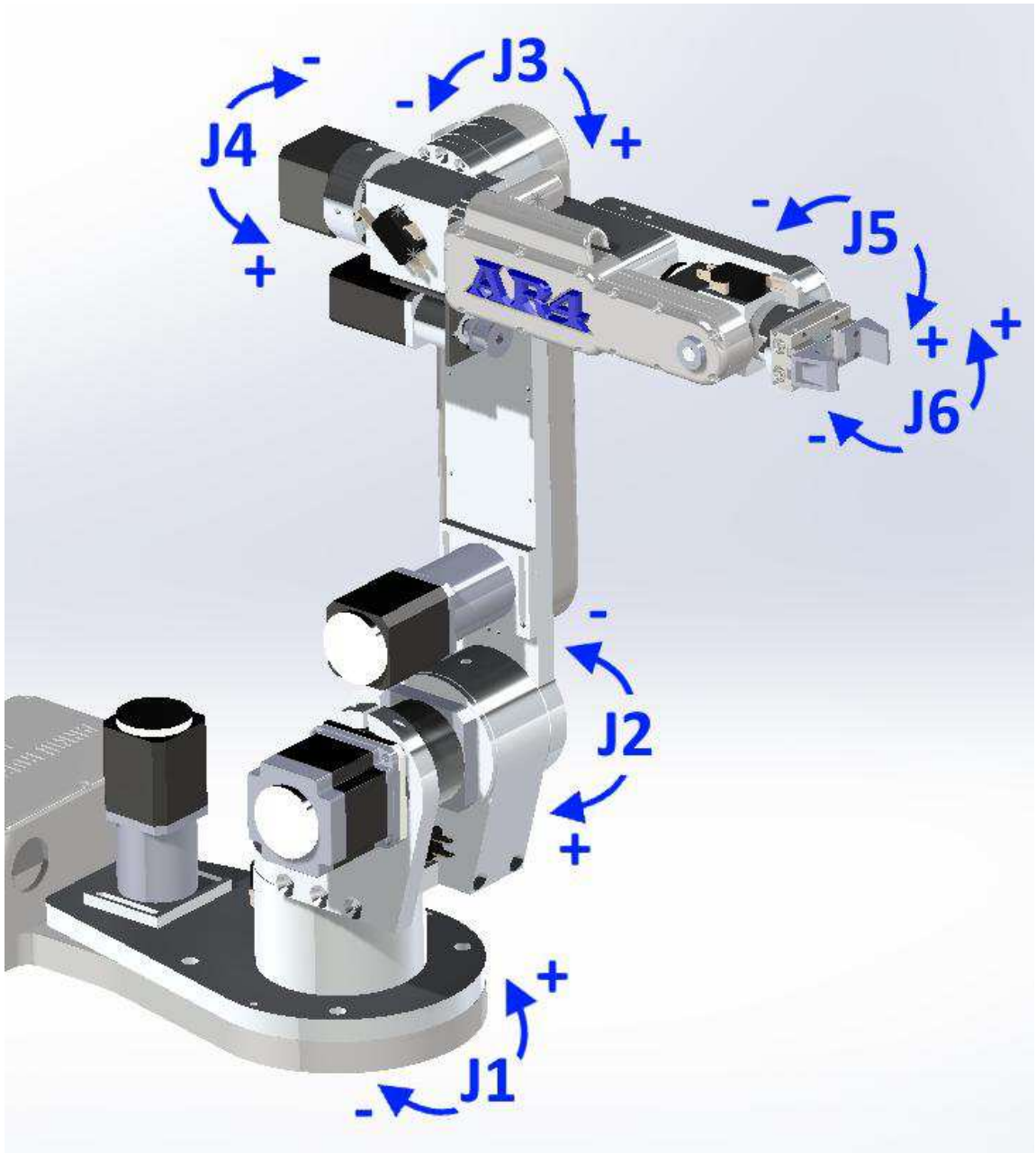

- After verifying each joint is jogging in the correct direction the next task is to verify each joint is jogging the correct distance. You can use a mechanical angle gauge but a digital angle gauge such as the one shown in the general assembly notes. Place the angle gauge on a flat surface of each joint and then verify when jogging that joint 10 degrees that it actually moves 10 degrees. For example on joint 3 place the gauge on the upper arm as shown – at this point it doesn't matter what position the joint is currently in, press the zero button – the gauge should read zero, now jog the joint down 10 degrees and verify it actually moves ten degrees.



- If you find a joint is not moving the correct distance the primary thing to check is the micro step settings on the driver, if the settings are incorrect the joint will not move the correct distance. The other mistake that I have seen is when the motors for J1 and J3 get mixed up and installed on the wrong joint.
- The next thing to check is each of the limit switches. Load the limit switch testing program: enter “test limit switches” in the program window and click the Load Program button.

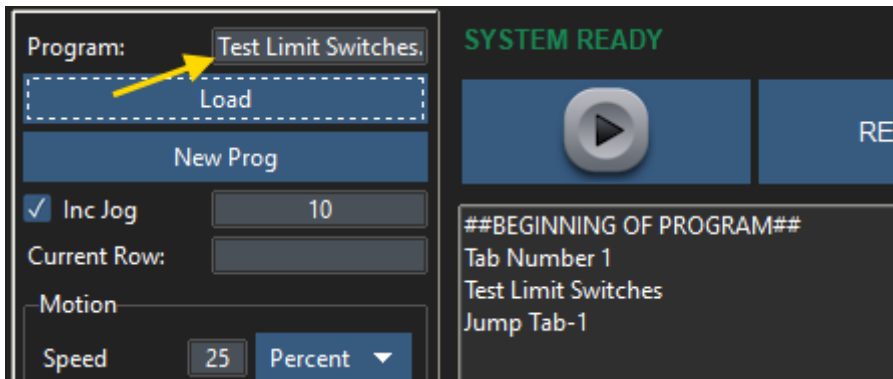

- Press the play button to run the program. When the program is running the manual entry field at the bottom of the screen will display a 0 or 1 value for each joint. You can now manually press the J4, J5 or J6 limit switch or carefully drive J1, J2 or J3 to its hall effect sensor and verify it is working.

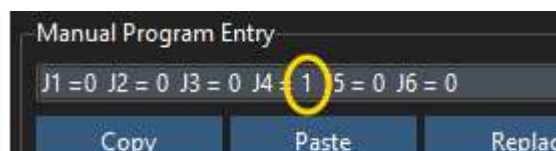

EXAMPLE TESTING JOINT 4 LIIMIT SWITCH

- **Note: you may need to adjust each of the sensor mount positions on the slotted screws.**
- Earlier in the build manual when installing the J2 sensor, the manual shows temporarily powering and adjusting the J2 limit switch. You will now need to do the same with Joint 1 and joint 3.
- Adjust the sensor mount position as needed and bend the sensor head leads as needed to ensure the sensor triggers reliably every time. The image below shows joint 3 in its calibration position with the sensor being triggered in its correct position.

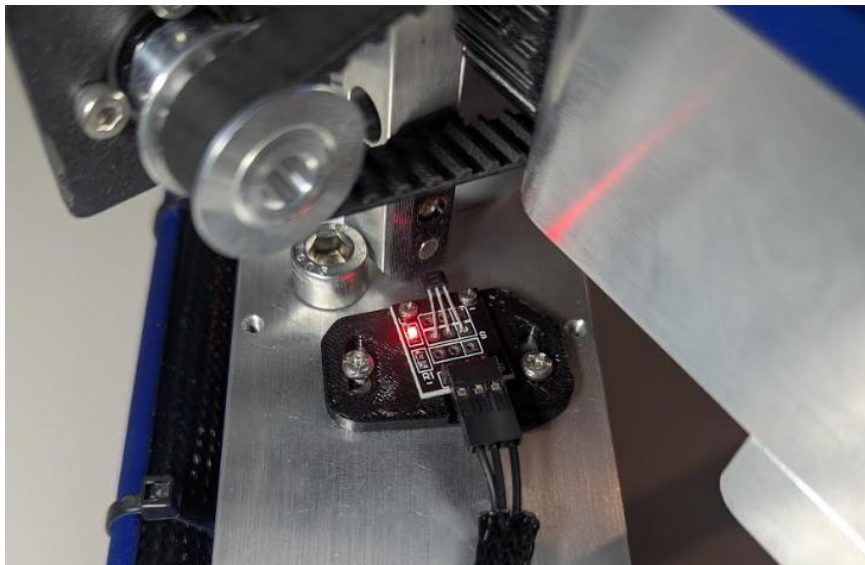

- The J4 timing screw may need to be adjusted so that it contacts the limit switch when joint 4 is rotated. Make sure the 24vdc power to the robot is turned off and then rotate J4 until the M3x6 button head screw contacts the limit switch. Turn the screw in or out appropriately so that the switch is contacted and verify that the J4 limit switch signal in the test limit switch program goes high when J4 is manually rotated.

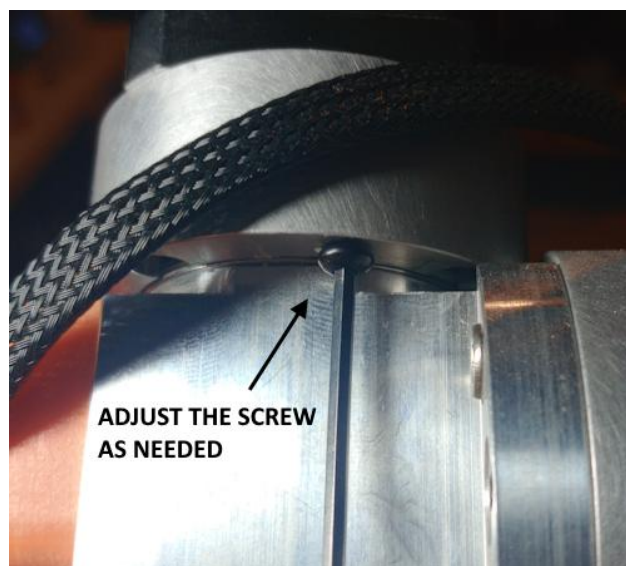
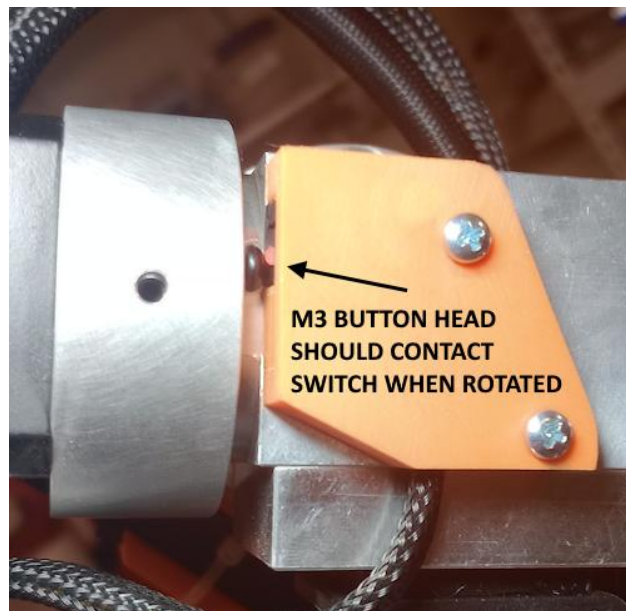

- Next we will check all the encoders, on the Config Settings tab uncheck the check boxes for disabling the encoders:

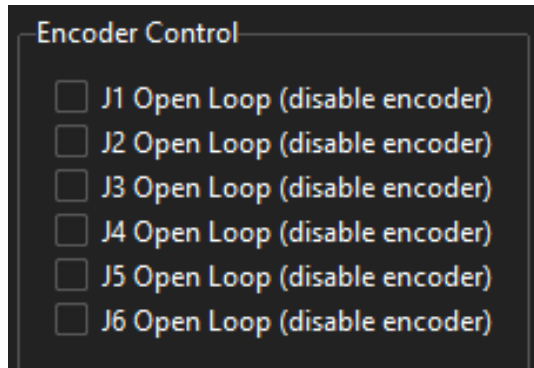

- Load the encoder testing program. Press the play button to run the program. When the program is running the system message in the manual entry field at the bottom of the screen will display a value of 1000 for each joint. Turn of power to your control enclosure to remove power from the robot motors (don't unplug the USB to your teensy board only shut off driver power). You can now manually manipulate each motor in both directions and verify the value shown for each encoder goes up or down depending on which direction you are moving each joint. See picture on next page to see what the screen should look like when testing the encoders.



- When testing the encoders the 1000 number and the number of counts it shows are arbitrary and only meant to show you a display of the encoder functioning.

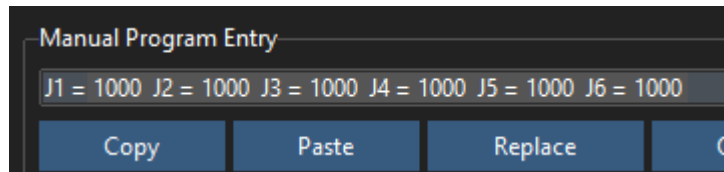

- If you find any of the encoders are not responding in either direction double check all of the wiring including the wiring of the keystone jacks as outlined in the previous section on checking the limit switch wiring.
- Next power your control enclosure back on and test jogging each joint – verify you do not get a joint collision or out of position alarm and that each joints position is reporting appropriately.
- The last step is to check your robots calibration. From the Config Settings tab click the Calibrate joint only button for each joint. The joint will travel to its limit switch, it will calibrate that joint to its limit and then travel back to zero. If you find a joint is off or not at zero after the calibration enter the amount the joint is off in the calibration offsets window for that joint, click the save button and then retry the calibration. See example on the next page.



- This example is for joint #3, in the picture below I have properly calibrated joints 1 and 2 first so that joint 2 is at a perfect 90 degrees, then I ran the calibration for joint 3 and then placed a digital level on the upper robot arm. You can see in this picture the joint is at an angle of 0.8°



- I then enter -0.8 in the calibration offset window and click save.

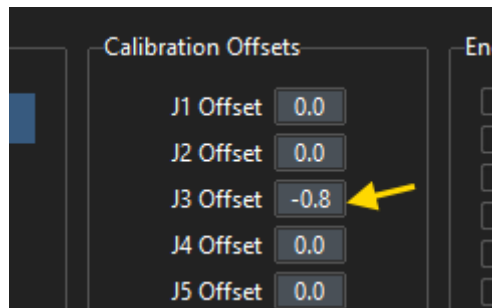

- Then after re-running the calibration the joint now calibrates correctly to a zero value.



This concludes the startup procedure, please review all the setup and programming videos on the tutorials page at www.anninrobotics.com



CHAPTER 9

ROBOT PROGRAMMING

Please see each of the AR4 programming tutorials:

<https://anninrobotics.com/tutorials/>



Version Log:

- 1.0 4/12/26 – original issue
- 1.1 6/8/26 – updated J3 sensor mount, updated belt tension, fixed missing text on page 187

